

INSTALLATION & USER INSTRUCTIONS

PROGRAMMABLE ROOM THERMOSTAT FR 110

FOR USE WITH THE FOLLOWING APPLIANCES:

GREENSTAR CDI COMBINATION BOILERS
GREENSTAR CDI SYSTEM BOILERS FITTED WITH OPTIONAL INTEGRAL DIVERTER VALVE
GREENSTAR HIGHFLOW CDI COMBINATION BOILERS

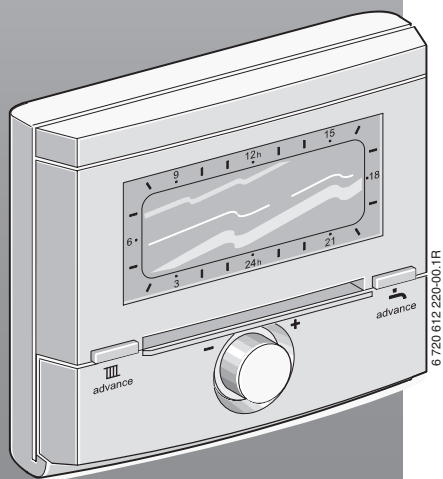

Overview of controls and symbols

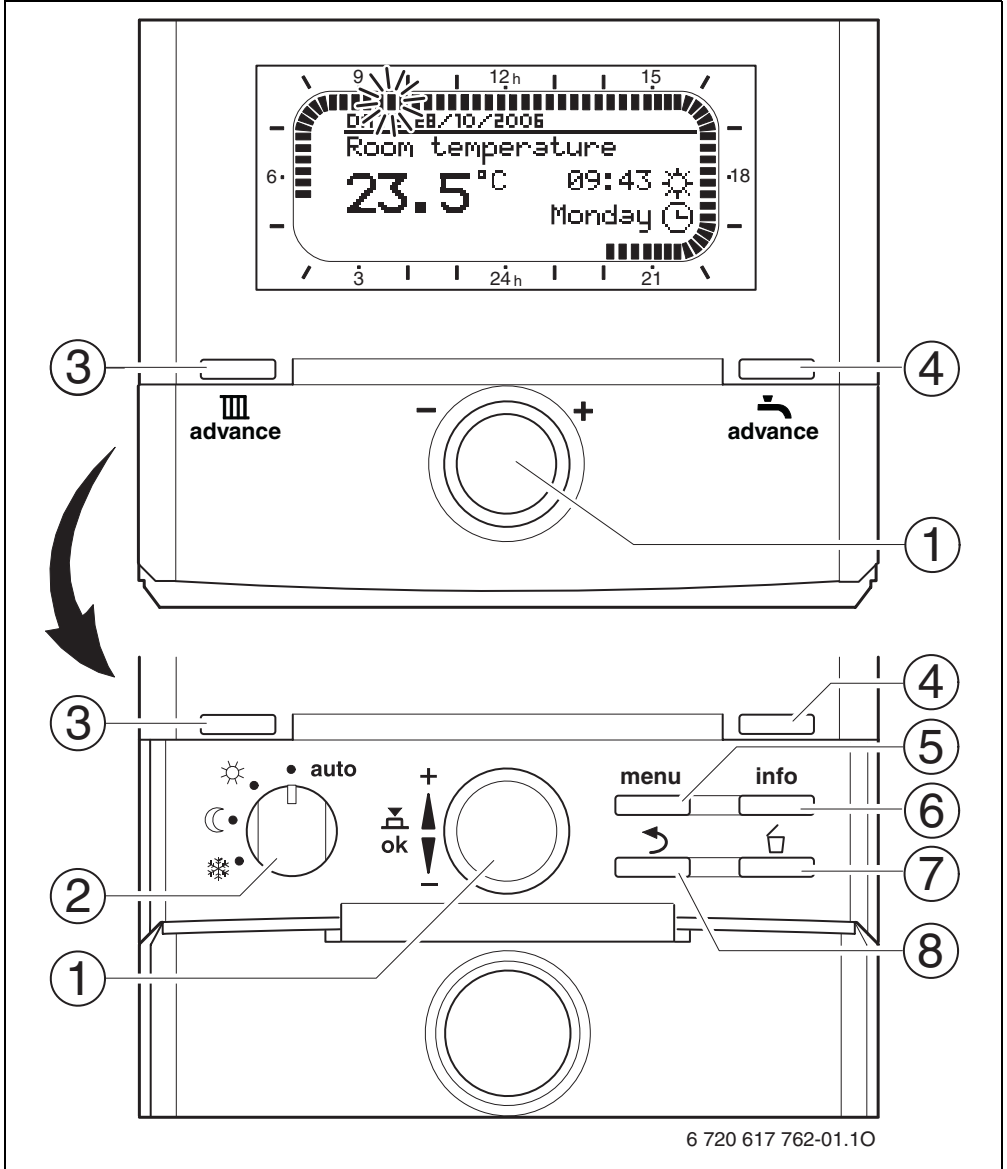



































Fig. 1 Controls

Controls	
1	Turning rotary selector  in + direction: scrolls menu/information up or increases setting value
	Turning rotary selector  in - direction: scrolls menu/information down or decreases setting value
	Pressing rotary selector  : opens menu or confirms setting/value or switches heating circuit
2	Mode selector for heating circuits:
	 auto Automatic mode
	 Continuous Comfort
	 Continuous Economy
 Continuous Frost	
3	 : Brings forward the next switching point and the associated operating mode  = Comfort ,  = Economy ,  = Frost for the heating circuit to now.
4	 : Activate domestic hot water mode immediately. The domestic hot water cylinder is heated to the desired temperature for 60 minutes or, with combination boilers, Comfort mode is activated for 30 minutes.
5	 : Open/close menu
6	 : Show settings
7	 : Delete/reset setting
8	 : Return to next menu up

Tab. 1

Symbols	
	Current room temperature
	Flashing segment: Time now (between 09:30 and 09:45)
	Solid segments: time set for operating mode  = Comfort today or hot water On (or $\geq 50\text{ °C}$) (1 segment = 15 min)
	Blank segments: time set for operating mode  = Economy today or domestic hot water Off (or $> 20\text{ °C}$ and $< 50\text{ °C}$) (1 segment = 15 min)
	No segments: time set for operating mode  = Frost today or domestic hot water $\leq 20\text{ °C}$ (1 segment = 15 min)
	Operating mode Comfort for heating circuit
	Operating mode Economy for heating circuit
	Operating mode Frost for heating circuit
	Automatic mode for heating circuit
	Holiday mode
	Burner operating
	Return to next menu up
	Other display information (menu options) is available. They can be viewed by by turning the rotary selector  .

Tab. 2

Contents



Chapters against a grey background are intended for installers. The pages concerned are identified by a grey vertical bar at the side of the page.

Overview of controls and symbols 2

Information about this documentation .. 6

1 Symbols and safety precautions 7

- 1.1 Symbols 7
- 1.2 Safety precautions 8

2 Technical data for the accessory item ... 9

- 2.1 Standard package 9
- 2.2 Technical data 10
- 2.3 Supplementary accessories 10
- 2.4 Cleaning 10
- 2.5 Sample system 11

3 Installation (for installers only) 12

- 3.1 Installation 12
 - 3.1.1 Fitting the heating controller 12
 - 3.1.2 Fitting other accessories 13
 - 3.1.3 Disposal 13
- 3.2 Electrical connections 14
 - 3.2.1 Connecting the BUS link 14

4 Commissioning (for installers only) ... 15

5 Operation 16

- 5.1 Heating and domestic hot water programmes 17
 - 5.1.1 General information 17
 - 5.1.2 Weekly programmes 17
 - 5.1.3 Structure of programmes 17
- 5.2 Setting programmes 18
 - 5.2.1 Viewing on the display and navigating through the menu 18
 - 5.2.2 Setting and changing the switching points and operating modes 19
- 5.3 Manually setting operating modes 23
 - 5.3.1 Selecting the heating mode 23
 - 5.3.2 Advancing the heating mode before the programmed time (bringing forward the next switching point) 23
 - 5.3.3 Changing the hot water mode (time-limited) 24
 - 5.3.4 Holiday programme 24
- 5.4 Changing the specified room temperature 25
 - 5.4.1 Permanently changing the specified room temperature .. 25
 - 5.4.2 Changing the specified room temperature for a limited period . 25

6 MAIN MENU settings 26

- 6.1 MAIN MENU summary and settings 26
 - 6.1.1 MAIN MENU: Holiday 27
 - 6.1.2 MAIN MENU: Heating 28
 - 6.1.3 MAIN MENU: Domestic hot water . 30
 - 6.1.4 MAIN MENU: General settings 32
 - 6.1.5 MAIN MENU: Solar 32
- 6.2 Heating program 33
 - 6.2.1 Timer programmes for heating ... 33
 - 6.2.2 Temperature levels for the operating modes 36
- 6.3 DHW programme 36
 - 6.3.1 Timer programme for domestic hot water with combination boiler ... 38
 - 6.3.2 Timer/temperature programme for domestic hot water (systems with domestic hot water cylinder only) 39

6.3.3	Timer programme for domestic hot water circulation pump (systems with domestic hot water cylinder only)	40
6.3.4	Parameters for domestic hot water (systems with domestic hot water cylinder only)	41
6.3.5	Thermal disinfection of domestic hot water (systems with domestic hot water cylinder only)	42
6.4	General settings	43
6.4.1	Time, Date and Auto switch between GMT - BST	43
6.4.2	Display formats	43
6.4.3	Key lock	43
6.4.4	Language	43
6.5	Solar settings	44
<hr/>		
7	Viewing information	45
<hr/>		
8	INSTALLER SETTINGS menu settings (for installers only)	48
8.1	INSTALLER SETTINGS menu summary and settings	48
8.1.1	INSTALLER SETTINGS: System configuration	49
8.1.2	INSTALLER SETTINGS: Heating parameters	49
8.1.3	INSTALLER SETTINGS: Solar system config	49
8.1.4	INSTALLER SETTINGS: Solar sys parameters	50
8.1.5	INSTALLER SETTINGS: Fault history	50
8.1.6	INSTALLER SETTINGS: Cust service address	50
8.1.7	INSTALLER SETTINGS: System info	51
8.2	Configuring the heating system	52
8.3	Parameters for heating	53
8.4	Configuring the solar thermal system	54
8.5	Parameters for solar thermal system	54
8.5.1	Commissioning the solar thermal system	55
8.5.2	Parameters for the standard solar thermal system	55
8.5.3	Parameters for solar optimisation	56
8.6	Fault history	58
8.7	Viewing and entering the customer service address	58
8.8	Viewing system information	58
<hr/>		
9	Troubleshooting	59
9.1	Troubleshooting using the display (for installers only)	59
9.2	Troubleshooting without using display	63
<hr/>		
10	Tips on saving energy	64
<hr/>		
11	Environmental protection	66
<hr/>		
12	Commissioning log for the heating system	67
<hr/>		
13	Individual timer programme settings	68
13.1	Heating programme for heating system	68
13.2	DHW programme	74
13.3	Domestic hot water circulation programme (only on systems with DHW cylinder)	75
<hr/>		
	Index	76

Information about this documentation

Guide to instructions



These installation and operating instructions contain all details of the function and operation of the FR 110 heating controller.

- ... are looking for a particular reference in the document, have a look in the **Index** at the end of this booklet.

If you ...

- ... are looking for the safety instructions and an explanation of the symbols, refer to **Section 1**.
- ... are looking for a summary of the design and function of the FR 110 heating controller, refer to **Section 2**. You will also find the technical data there.
- ... are an INSTALLER and you want to know how to install, electrically connect and commission this accessory, refer to **Sections 3 and 4**.
- ... want to know how to operate and program this accessory, refer to **Sections 5, 6 and 13**. There you will also find summaries of the default settings and setting ranges for the menus. There are also tables for making a note of your settings.
- ... want to view information about the operating mode of the heating system, refer to **Section 7**.
- ... are an INSTALLER and want to make installer settings or view system information, refer to **Section 8**. There you will also find summaries of the default settings and setting ranges for the menus. There are also tables for making a note of your settings.
- ... are looking for troubleshooting tables, refer to **Section 9**.
- ... are looking for tips on saving energy, refer to **Section 10**.

1 Symbols and safety precautions

1.1 Symbols



Safety instructions in this document are framed and identified by a warning triangle which is printed on a grey background.

Signal words indicate the seriousness of the hazard in terms of the consequences of not following the safety instructions.









- **Caution** indicates that minor damage to property could result.
- **Warning** indicates that minor personal injury or serious material losses could result.
- **Danger** indicates that serious personal injury could result. In particularly serious cases, lives could be at risk.



Notes are identified by the symbol shown on the left. They are bordered by horizontal lines above and below the text.

Notes contain important information in cases where there is no risk of personal injury or material losses.

Conventions used in these instructions for representing the menu structure:

- Individual menu levels are separated by the character > , e.g. **Holiday > Start**
- Parameters that can be set/selected on a menu are marked with a bullet point • .
- The operation of a control is indicated by the symbol for the control:
 -  means turn rotary selector
 -  means press rotary selector
 -  means press and release Menu button
 -  means press and release Info button
 -  means press and release Delete/Reset button
 -  means press and release Menu Up button
 -  means press and release Advance button
 -  means press and release Immediate Domestic Hot Water button

1.2 Safety precautions

- ▶ These instructions must be observed to ensure correct operation.
- ▶ Install and commission the boiler and all accessories in accordance with the installation instructions.
- ▶ This accessory must only be installed by suitably qualified installers.
- ▶ Only use these accessories in conjunction with the heating appliances listed. Follow the connection diagram!
- ▶ Do not connect this accessory to the 230 V mains electricity supply.
- ▶ Before installing these accessories: Isolate the voltage supply (230 V AC) to the heating appliance and all additional devices on the bus.
- ▶ Never install this accessory in wet areas.
- ▶ Instruct customers about the functions and operation of accessories.
- ▶ Risk of scalding during thermal disinfection: Supervise short periods of boiler operation with water temperatures over 60 °C or fit a thermostatic mixer unit.
- ▶ When there is a risk of frost, leave the boiler switched on and follow the frost protection information.

Risk of damage due to operator error.



Incorrect operation can cause personal injury and/or damage to property.

- ▶ Ensure children do not operate or interfere with this accessory.
- ▶ Make sure that only people who are capable of operating this accessory properly have access to it. This appliance must only be operated by a responsible adult who has been instructed in, understands and is aware of its operating conditions and effects.

2 Technical data for the accessory item



The FR 110 can only be connected to a boiler with BUS-enabled Heatronic 3.

- This controller is used to display boiler and system information and to change the settings shown. The FR 110 can either be used with a System Boiler fitted with an optional integral diverter valve or a Combination boiler.
- The FR 110 can either be used with a System Boiler fitted with an optional integral diverter valve or a Combination boiler.
- This controller is a room thermostat with the following timer programming options:
 - Central heating : 6 weekly heating programmes with 6 switching points per day are programmable (one programme is active).
 - Domestic hot water : weekly hot water programme with 6 switching points per day.
- The controller also has a selectable Heat-up optimisation function.
- Options:
 - ISM 1module for solar water heating.
- Installation:
 - Wall-mounted with BUS link to boiler with BUS-enabled Heatronic 3
- The controller has a back-up battery sufficient for at least 6 hours of operation. If the controller is without mains power for longer than 6 hours then the time and date are lost. All other settings are saved.

2.1 Standard package

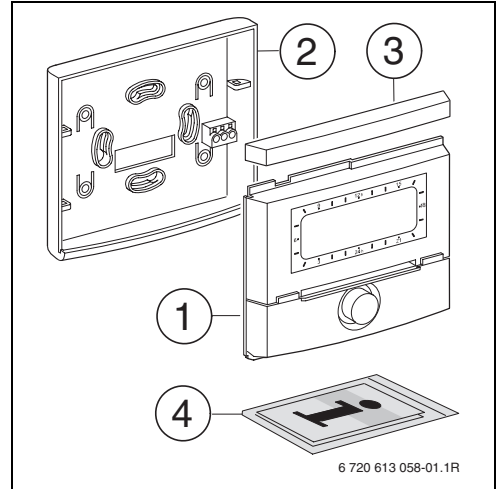

Fig. 2 Standard package

- 1** Controller top section
- 2** Base for wall-mounting
- 3** Slide cover
- 4** Installation and operating instructions

2.2 Technical data

Dimensions	Fig. 4, page 12
Rated voltage	10...24 V DC
Rated power (excluding illumination)	6 mA
Controller output:	2-wire BUS
permiss. ambient temperature	0 ... +50 °C
Class of protection	III
Protection level	IP20
	CE

Tab. 3 Specification

2.3 Supplementary accessories

- **ISM 1:** module for controlling solar water heating.

2.4 Cleaning

- ▶ If required, use a damp cloth to wipe the controller casing. Never use aggressive or acidic cleaning agents for this.

2.5 Sample system

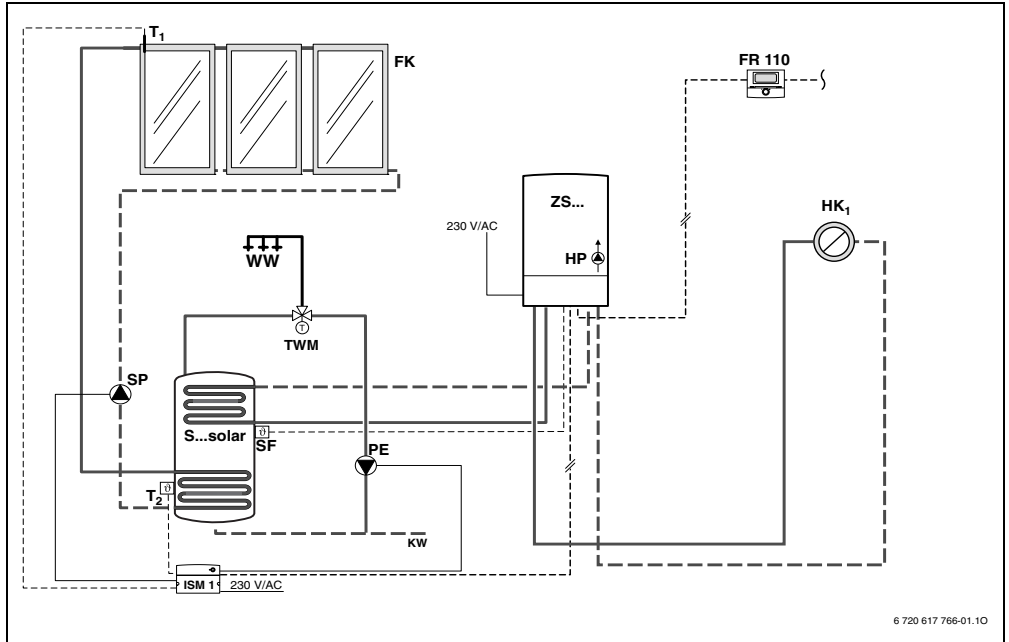

Fig. 3 FR 110 and CDi System Boiler with optional integral diverter valve and solar installation.

- FR 110** Programmable room thermostat for boiler with hot water cylinder
- FK** Flat plate collector
- HK** Heating circuit
- HP** Heating circuit pump
- ISM 1** Module for solar water heating
- KW** Cold water connection
- PE** Thermal disinfection pump
- S...solar** Solar storage cylinder
- SF** Cylinder temperature sensor (NTC)
- SP** Solar pump
- T₁** Collector temperature sensor
- T₂** Cylinder temperature sensor, bottom
- TWM** Thermostatic mixing valve to protect the end user from excessive domestic hot water temperatures
- WW** DHW connection
- ZS...** Boiler with cylinder connection

3 Installation (for installers only)



Danger: Risk of electric shock

- ▶ Before installing these accessories:

Isolate the voltage supply (230 V AC) to the heating appliance and all additional devices on the bus.

3.1 Installation

3.1.1 Fitting the heating controller

The installation location must be suitable for controlling the heating system or heating circuit.

The accuracy of the FR 110 is dependent upon the installation location.

Any radiator in the same room as the FR 110 should not have a thermostatic radiator valve fitted.

The FR 110 should be installed so that the overall temperature of the property is monitored, for example, hallways or landings and not be installed in a living room or room with supplementary heating.

- ▶ Select the installation location.

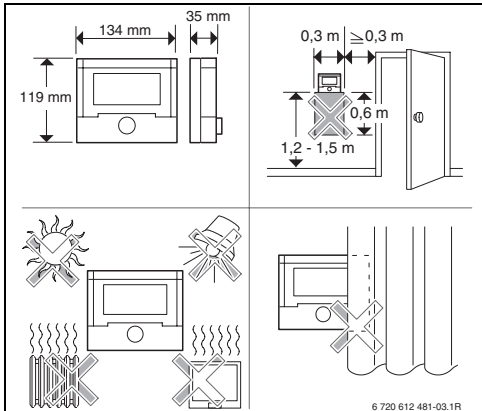

Fig. 4



The mounting surface on the wall should be level.

- ▶ Remove the top section and slide cover from the base.

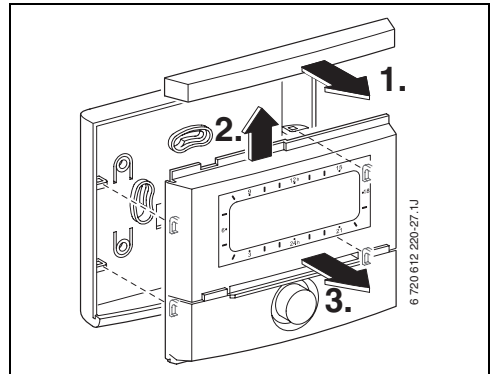

Fig. 5

- Fit the base.

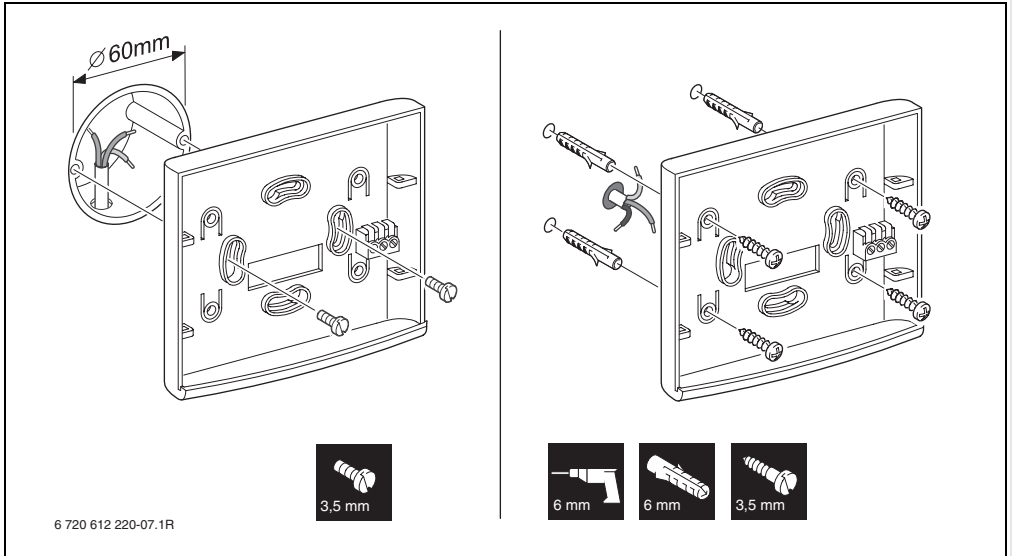

Fig. 6

- Make the electrical connections (→ Fig. 8 on page 14).
- Refit top section and slide cover on base.

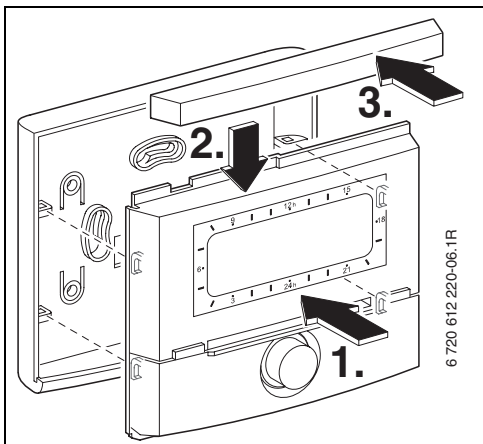

Fig. 7

3.1.2 Fitting other accessories

- Fit accessories according to the legal requirements and the installation instructions supplied with them.

3.1.3 Disposal

- Dispose of packaging in an environmentally responsible manner.
- When replacing components, dispose of the old parts in an environmentally responsible manner.

3.2 Electrical connections

- ▶ Use electrical cable with a minimum rating of H05 VV-... (NYM-l...).
- ▶ To avoid inductive interference, lay all bus cables separately to lines of 230 V or 400 V (minimum spacing 100 mm).
- ▶ In case of external inductive interference, shield the cables.
This ensures that the cables are shielded from external interference (e.g. heavy current cables, overhead wires, transformer stations, radio and television set, amateur radio stations, microwave ovens etc).

3.2.1 Connecting the BUS link

Permissible cable lengths from the BUS-enabled Heatronic 3 to the controller:

Cable length	Cross-section
≤ 80 m	0.40 mm ²
≤ 100 m	0.50 mm ²
≤ 150 m	0.75 mm ²
≤ 200 m	1.00 mm ²
≤ 300 m	1.50 mm ²

Tab. 4

- ▶ Connect the controller to a boiler with BUS-enabled Heatronic 3.

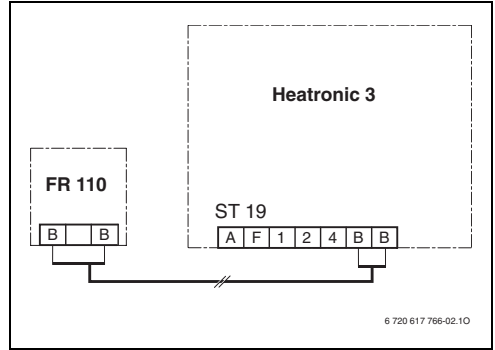

Fig. 8 Controller connected to BUS-enabled Heatronic 3.



If the BUS cables feature different cross-sections:

- ▶ Connect BUS link via a branch box.

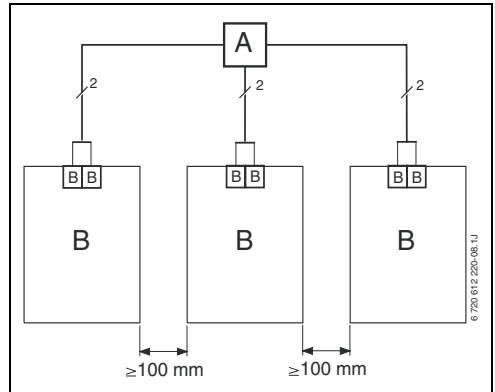

Fig. 9 BUS links connected via branch box (A)

4 Commissioning (for installers only)

For correct commissioning, it is essential that the following steps are carried out in the order shown.

1. Switch on the system.



The functions of the controls and the meanings of the symbols on the display are explained on pages 2 and 3.

2. When commissioning for the first time or after a complete reset (all settings have been reset):
 - Turn to select the language and press to confirm. (For how to change the language → Section 6.4.4 on page 43.)
3. If the reserve power supply has run out, set the date and time as follows:
 - Turn to select the hour and press to confirm.
 - Turn to select the minute and press to confirm.
 - Turn to select the year and press to confirm.
 - Turn to select the month and press to confirm.
 - Turn to select the day and press to confirm. (For how to change the date and time → Section 6.4.1 on page 43.)
4. When the unit is first commissioned, automatic system configuration starts immediately after entry of the date and time.
 - Wait for 60 seconds and then follow the instructions displayed.
 - If automatic system configuration does not start of its own accord, start it from the menu → Section 8.2 on page 52.
5. Adjust other settings to suit the specifics of the system, → Section 6 starting on page 26 and Section 8 starting on page 48.
6. Fill and bleed the solar thermal system according to its documentation and prepare it for commissioning as described in Section 8.4 on page 54.
7. Adjust other settings to suit the specifics of the solar thermal system, → Section 8.5 starting on page 54.
8. Commission the solar thermal system, → Section 8.5.1 on page 55.
9. Inform the user of the system about its function and method of operation as follows:
 - Explain to the customer how the boiler and the controller work and how to operate them.
 - Explain to the user the operations for day-to-day use, e.g. setting the time, operating modes for the heating system, domestic hot water temperature, timer programmes for heating and hot water.
 - Explain the use of the thermal disinfection function and the associated risk of scalding.
 - Hand all documentation supplied to the user.
10. Complete the commissioning log, → Section 12 on page 67.

5 Operation

Introduction

With the FR 110 heating controller, you can automatically control the room temperature and domestic hot water temperature with a heating and hot water programme created according to your own individual requirements.

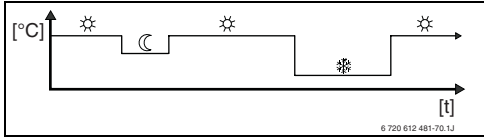

Fig. 10 Example of heating programme

Once the controller is set to your personal preferences, you hardly need the menus for “everyday use”. Nevertheless, it is useful to be familiar with the basic use of the menus.

Therefore, you should read the whole of Sections 5.1 and 5.2 below and adjust a heating or hot water programme to your own requirements as described in Section 5.2.2.

The procedure for changing a switching point will illustrate everything you need to know about navigating through the menus and entering settings. You can then make all other settings in the same way with the aid of the information in Sections 6 and 8.

The description of the menus reflects the arrangement of the menu options on the heating controller. The tables in Sections 6.1, 7 and 8.1 show the entire menu structure. They also provide details of the adjustment ranges and default settings for all adjustable parameters. More information on the menu options can be found in Sections 6.2 to 6.5 for user settings, and Sections 8.2 to 8.8 for installer settings.

The description of a menu options starts with its menu path. That shows you how to reach the menu option concerned through the system of

menus. The individual menu levels are separated by the character **>**, e.g. **Holiday > Start**

Some menu options are dependent on others. In such cases, a page reference directs you to a description of the menu option on which it depends. Make use of such page references to other menu options. They will help you to understand associated functions.



The controller provides the option of setting the desired room temperature for the operating mode concerned.

5.1 Heating and domestic hot water programmes

5.1.1 General information

The programmes for heating and hot water enable you to achieve maximum energy savings while still enjoying optimum comfort in terms of room temperature and availability of domestic hot water. That is achieved, for instance, by deactivating water heating in the periods when nobody requires domestic hot water.

5.1.2 Weekly programmes

All timer programmes are set up to repeat every seven days. In the programme memory you can store 6 switching points for every day in each programme, i.e. a total of up to 42 switching points.

To simplify programming, you can set switching points for groups of days as well as for individual days.

The following groups of days are offered:

- **All days**
- **Mon - Fri**
- **Sat + Sun**

If, for example, you change and store a switching point for the option **Mon - Fri**, that change is simultaneously applied to all days from **Monday** to **Friday**.

5.1.3 Structure of programmes

Programmes for heating and domestic hot water are always structured in the same way. Up to six switching points (times) can be specified. A change of operating mode is specified for each switching point. The specified operating mode applies until changed by the next switching point.

Heating programmes

Heating programmes control central heating operation. There are three modes for heating operation:

- **Comfort** ☀
- **Economy** ☾
- **Frost** (Frost protection) ❄

-or-

Individual temperature levels:

- **5 °C to 30 °C** in 1 °C increments.

For each of those operating modes, there is a specified room temperature stored on the FR 110 heating controller (→ Section 5.4.1, page 25).

There are a total of six programme spaces (A to F) available for heating programmes. Each heating programme contains the switching times for one week (weekly programme). You can activate one heating programme at a time.



Having several stored heating programmes simplifies changing from one heating programme to another, e.g. if your job involves periods when you work different shifts (night shift/day shift), or for holiday periods.

Domestic hot water programmes

Hot water programmes operate differently according to the type of hot water system:

- With combination boilers (boilers which produce domestic hot water instantaneously on demand) the hot water programme switches between the following operating modes:
 - **On:** if the Eco button on the boiler is not lit, domestic hot water is available very quickly on demand (Comfort mode).
 - **Off:** the built-in water heater in the boiler is not kept constantly hot (Eco mode); as a

result energy is saved. In Eco mode, the hot tap has to be run for a short while before the water becomes hot.

- With boilers connected to a hot water cylinder, the hot water programme specifies the desired water temperature (specified temperature).
 - If the temperature measured in the domestic hot water cylinder is below the specified temperature, the cylinder is re-heated.
 - Once the specified temperature is reached (or exceeded), cylinder heating is stopped.



If the domestic hot water programme changes from a higher to a lower specified temperature, the water in the cylinder will not immediately cool to the lower temperature, i.e. water at a higher temperature will continue to be available for some time. However, the cylinder will not be reheated until the temperature falls below the new, lower specified temperature.

DHW circulation program

The circulation programme specifies when the secondary circulation pump for domestic hot water circulation runs.

5.2 Setting programmes

















The functions of the controls and the meanings of the symbols on the display are explained on pages 2 and 3.

5.2.1 Viewing on the display and navigating through the menu

The user interface of the FR 110 programmable room thermostat is implemented as a menu system. Within that menu system, the various functions are arranged in a hierarchical structure. For greater clarity, the menu system is subdivided into three sections (**MAIN MENU**, **INFO**, and **INSTALLER SETTINGS**). Each section can be accessed by its own button. The entire menu structure is shown in tabular form in Sections 6.1, 7 and 8.1.

To navigate through the menu system:

- Pressing  opens the **MAIN MENU**. From any point within the **MAIN MENU**, pressing  takes you back to the basic display.
- Pressing  opens the **INFO**. From any point within the **INFO** menu, pressing  takes you back to the main menu.
- Pressing and holding  for at least 3 seconds opens the **INSTALLER SETTINGS** menu. From any point within the **INSTALLER SETTINGS** menu, pressing  takes you back to the main menu.
- The menu option/parameter selected in each case is shown **inverted**.
- Arrows in the left margin indicate that there is more information than can be shown on the display at once. It can be viewed by turning the rotary selector .
- Pressing the rotary selector  opens the submenu associated with the selected menu option/parameter or activates editing mode for the parameter (the parameter setting starts flashing).

- A flashing parameter setting (e.g. switching point or operating mode)
 - can be changed by turning the rotary selector .
 - can be deleted (reset to the default) by pressing .
 - is stored by pressing the rotary selector .
 - remains unchanged if any other button apart from the rotary selector  is pressed.
- To return to the next menu up from a sub-menu:
 - Select the menu option **◀ Back** and confirm by pressing the rotary selector ,
 - or
 - Press .

5.2.2 Setting and changing the switching points and operating modes

The way in which switching points and operating modes are set is always the same, the only differences are due to the various operating modes for each switching point.

The unit is supplied with programmes for heating and domestic hot water already stored. It may also be that your heating installer has adjusted the programmes to suit your requirements.

Changing (moving or deleting) a single switching point



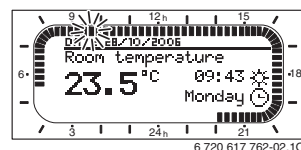

The example below shows all the steps required to change a switching point in a heating programme. If, instead, you want to change a switching point in a domestic hot water programme, open the hot water programme concerned (menu path: **Domestic hot water > DHW programme > Edit**) and change the switching point in the same way.

- ▶ Open flap.
 - The basic display continues to be shown.

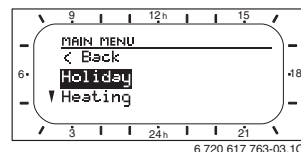

- ▶ Press .
 - The display lighting switches on and the main menu is displayed.



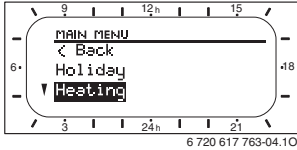

- ▶ Turn the rotary selector  until the menu option **Heating** is selected.

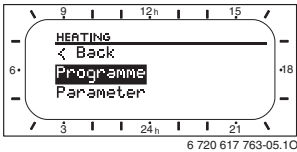

- ▶ Press .

The Heating menu is selected and the title bar shows the current menu name (in this case **HEATING**).





- ▶ Turn the rotary selector  until the menu option **Programme** is selected.

- ▶ Press .

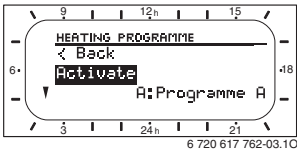
The Programme menu is selected and the title bar shows the current menu name (in this case **HEATING PROGRAMME**).





- ▶ Turn the rotary selector  until the menu option **Edit** is selected.

- ▶ Press .

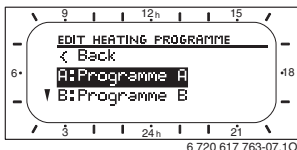
The **Edit** menu is selected and the title bar shows the current menu name (in this case **EDIT HEATING PROGRAMME**).



- ▶ Turn the rotary selector  until the desired heating programme is selected (e.g. **A:Programme A**).

- ▶ Press .

The heating programme (e.g. A:Programme A) is selected and the title bar shows the current menu name (**EDIT PROGRAMME A**).

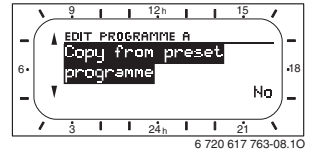

- ▶ Turn the rotary selector  until the desired day (or group of days) is selected (e.g. **Monday**).

The display always shows the ring of segments representing the heating programme settings when you select a single day (e.g. **Monday**) or a group of days in which the switching points are identical for all the days in that group (e.g. all switching points for **Mon - Fri** identical).

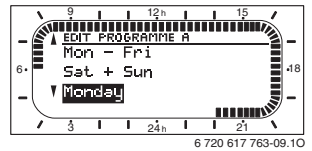

- ▶ Press the rotary selector  to confirm the menu option **Monday**.

The next submenu (**EDIT PROGRAMME A MON**) showing the programmed switching points and operating modes **P1** to **P6** is displayed.

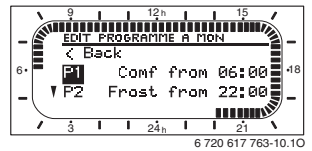

- ▶ Turn the rotary selector  until the menu option **P1** (= switching point 1) is selected.

- ▶ Press .

The switching point and corresponding segment on the display start to flash.

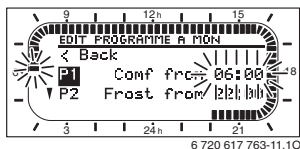

- ▶ Turn the rotary selector  until the desired time is displayed (e.g. **05:30**).

The ring of segments around the perimeter of the display always shows the effect of the change on the heating programme.

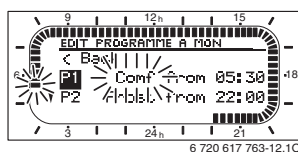



- ▶ Press .

The switching point is saved. The associated operating mode now starts flashing on the display.

- ▶ Turn the rotary selector  until the desired operating mode (e.g. **Economy**) or temperature is displayed.

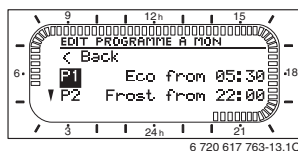
The ring of segments around the perimeter of the display always shows the effect of the change on the heating programme.



- ▶ Press .

The operating mode is saved. Setting of **P1** is now complete.

- ▶ You can now:
 - change more switching points and operating modes in the same way, or
 - finish programming and return to the basic display by pressing .

Using groups of days when programming

In many cases, you may want to programme the same switching points for several days of the week, say for all working days. Equally, you may also want a different programme for just one of those days.

Using the groups of days when programming enables you to complete the process in only a few steps.

- ▶ For a group of days, e.g. **Mon - Fri**, programme the switching points and operating modes that are the same for the majority of those days.
- ▶ Then change the switching points for the days that are different.

Copying ready-made programmes

There are eight ready-made heating programmes permanently stored on the heating controller. They can not be directly applied to a heating circuit.

To be able to use the ready-made heating programmes, you must copy them to one of the locations for heating programmes (A to C), where you can also adapt them if necessary (→ Section 5.2.2).



You can also copy any of the programmes A to C or D to F to another storage location as a template.

Select the storage location **to which the programme is to be copied** (A to F):

- ▶ Open menu option **Heating > Programme > Edit > A:Programme A ... F:Programme F**.
- ▶ Press the rotary selector $\frac{\Sigma}{ok}$ twice. The function **Copy from preset programme** is selected and the option **No** is flashing.

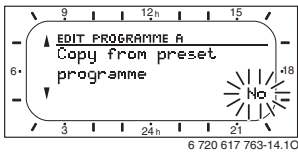

- ▶ Turn the rotary selector \uparrow until the last line of the display shows the heating programme that is to be copied (e.g. **Full weekday worker**).
- ▶ Press $\frac{\Sigma}{ok}$. The heating programme has now been copied.

Resetting an entire programme (replacing with default settings)

The unit is supplied with programmes for heating and domestic hot water already stored in the memory (→ Section 13 on page 68).

Overwrite one of your own heating programmes, A to F, as follows:

- ▶ Open the programme concerned (e.g. menu path: **Heating > Programme > Edit > C:Programme C** or menu path: **Domestic hot water > DHW programme > Edit**).
- ▶ Turn the rotary selector \uparrow to select the option **Reset factory settings**.
- ▶ Press $\frac{\Sigma}{ok}$. The programme has not been reset to the default settings.

Resetting all settings (for installers only)

This function resets all settings on the **MAIN MENU** and the **INSTALLER SETTINGS** to their default settings. **Following such a reset, your heating installer will need to commission the system again.**

If the basic display is showing:

- ▶ Simultaneously press and hold $\frac{\text{menu}}$ and $\frac{6}{\text{ok}}$ until the following warning message appears:

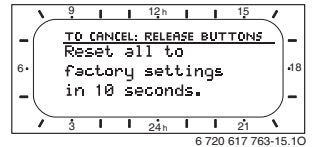

- ▶ Continue holding $\frac{\text{menu}}$ and $\frac{6}{\text{ok}}$ until the following message appears:

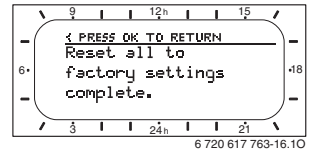

- ▶ Press $\frac{\Sigma}{ok}$. All settings have now been reset to their defaults with the exception of the date and time, which remain unchanged.

5.3 Manually setting operating modes

5.3.1 Selecting the heating mode



In normal operation, always leave the rotary selector in the **auto** position. By using correctly set heating programmes, you can save energy while enjoying comfort.



Automatic mode (default setting)

Switches automatically between the modes **Comfort** ☀ / **Economy** ☾ / **Frost** ❄ according to the active heating programme.



Constant heating

The controller constantly maintains the room temperature set for **Comfort** ☀ mode.



Constant economy

The controller constantly maintains the room temperature set for **Economy** ☾ mode.



Constant frost protection

The controller constantly maintains the room temperature set for **Frost** ❄ mode.

5.3.2 Advancing the heating mode before the programmed time (bringing forward the next switching point)

This function brings forward the time at which the mode **Comfort** ☀ / **Economy** ☾ / **Frost** ❄ or the specified room temperature set for the next switching point becomes active.



The change applies only to the day on which you activate the function.

- ▶ The function can be used in situations such as going to bed earlier, being away from home longer or coming back later.
- ▶ If you are going to be away from home for several days, e.g. on holiday, you should use the Holiday function, → Section 5.3.4, page 24.

This function is only available when **auto** mode is switched on.

- ▶ Press and release  to bring forwards the next switching point and the associated operating mode **Comfort** ☀ / **Economy** ☾ / **Frost** ❄ for the selected heating circuit to now.

The segments around the perimeter of the display show the changed settings.

-or-

- ▶ Press and hold  and simultaneously turn the rotary selector  to change the next switching point.

The segments around the perimeter of the display show the changed settings.

To undo the change to the switching point:

- ▶ Press  again.

5.3.3 Changing the hot water mode (time-limited)



You can use this function if you need domestic hot water outside the programmed times.

- ▶ Press and release  to activate domestic hot water mode immediately.
 - The domestic hot water cylinder is heated up to the temperature set in the hot water programme for 60 minutes.
 - With a combination boiler, Comfort mode is activated for 30 minutes.

To undo the change to the domestic hot water mode:

- ▶ Press  again.

5.3.4 Holiday programme





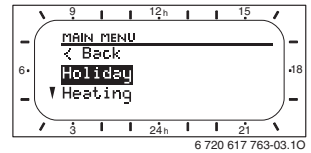

You can use this function if you want to set a constant operating mode for several days (e.g.

Frost ) without changing the heating programmes.

When the holiday programme is active, the central heating and domestic hot water systems are operated according to the operating mode set in the holiday programme (frost protection is automatically provided).

- ▶ Press .
The display lighting switches on and the main menu is displayed.



- ▶ Press .
The **Holiday** menu is selected and the title bar shows the current menu name (in this case Holiday).
- ▶ Press the rotary selector , the display changes to the Holiday menu and **Start** is selected.
Now you can enter the date on which you want the holiday programme to start. Enter the year, month and day one after the other and confirm your entry in each case by pressing the rotary selector .
- ▶ Turn the rotary selector  so that **End** is selected.
- ▶ Press .
Now you can enter date on which you want the holiday programme to end. Enter the year, month and day one after the other and confirm your entry in each case by pressing the rotary selector .



If you have set the holiday programme to start on today's date, it will start immediately. If the date is in the future, the holiday programme will start at 00:00 hours on the set start date.



It will end at 23:59 hours on the set end date.

Programming of the holiday programme is now complete. If required, you can adjust the heating and domestic hot water modes. The following modes are set by default:

- **Heating system: Frost** ❄️ mode
- **Domestic hot water: Off** mode ¹⁾ or **15 °C**²⁾.
- **DHW circulation pump: Off** mode.
- **Thermal disinfection: Off** mode.

When the holiday programme is active, the standard display shows  and the dates, e.g. **HOLIDAY UNTIL 09/30/2008**.

To cancel the holiday programme early:

- ▶ Select menu option **Holiday > Start**.
- ▶ Press the rotary selector  and then press . The display shows ---:---:---.
- ▶ Press the rotary selector  to store the setting.

-
- 1) Domestic hot water provided by combination boiler
 - 2) Domestic hot water provided by DHW cylinder

5.4 Changing the specified room temperature



The controller provides the option of setting the desired room temperature for the operating mode concerned.

5.4.1 Permanently changing the specified room temperature

The following temperatures are stored as the default settings for the specified room temperature:

- **Comfort** ☀️ mode: 21 °C
- **Economy** ☾ mode: 15 °C
- **Frost** ❄️ mode: 5 °C

The heating controller controls the heating system so that actual room temperature is kept as close as possible to the specified temperature for the set operating mode (in **auto** mode as determined by the active heating programme and the time of day).

If you wish to permanently alter the specified room temperature settings, proceed as follows:

- ▶ Open menu option **Heating > Parameter > Heating levels**.
- ▶ Set the temperature for each operating mode (→ Section 6.2.2, page 36).

5.4.2 Changing the specified room temperature for a limited period

- ▶ Set the desired room temperature using the rotary selector .

While you are changing the specified room temperature, the display shows the desired room temperature.

- If the mode selector is set to **auto**: The new temperature applies until the next switching point.
- If the mode selector is set to ☀️ / ☾ / ❄️: The new temperature applies until the mode selector position is changed.

6 MAIN MENU settings

Detailed instructions on navigating through the menu structure, programming, deleting settings and resetting to the default settings are provided in Section 5.2 starting on page 18.

6.1 MAIN MENU summary and settings

The tables set out below provide

- an overview of the menu structure (column 1). The menu level is indicated by different shades of grey.
For example, on the menu **Heating > Programme**, the submenus **Edit** and **View** are at the same level.
- an overview of the default settings (column 2), e.g. for the purposes of resetting individual menu options to the default.
- an overview of the adjustment ranges of the individual menu options (column 3).
- space for making a note of your personal settings (column 4).
- references to the detailed descriptions of the individual menu options (column 5).



The menu options are only shown if the system components are present and/or active. Some menu options are not shown because they are switched off by a setting for another menu option.

- ▶ Always set or skip menu options in order. In that way, subsequent menu options will be automatically adjusted or not shown.
-

6.1.1 MAIN MENU: Holiday

Holiday menu structure ¹⁾	Default setting	Setting range	Personal setting	Description starts on page
Start	- - . - - - . - - - -	Today ... 12/31/2099 (in increments of one day/month/year)		24
End	- - . - - - . - - - -	Start date ... 12/31/2099 (in increments of one day/month/year)		
Heating	Frost	Frost Economy Comfort Auto		
Domestic hot water	Off ²⁾	Off Auto On ²⁾		
	15 °C ³⁾	15 °C ... 60 °C Auto ³⁾		
DHW circulation pump	Off	Off Auto On		
Thermal disinfection	Off	Off On		

Tab. 5

- 1) Only influences the boiler if the holiday key on the boiler was not enabled.
- 2) Domestic hot water provided by combination boiler
- 3) Domestic hot water provided by domestic hot water cylinder

6.1.2 MAIN MENU: Heating

Heating menu structure	Default setting	Setting range	Personal setting	Description starts on page
Programme	–	–	–	33
Activate	A:Programme A (switching points from Home all day-programme)	A:Programme A ... F:Programme F (Programme name can be changed)	–	
Edit	–	–	–	
A: Programme A ... C: Programme C	–	–	–	
Copy from preset programme	No	No A:Programme A ... C:Programme C (Programme name can be changed) AM weekday worker PM weekday worker Full weekday worker AM+PM weekday worker Home all day Home all day, early Home all day, late Senior citizens	–	
All days	→ table on page 71	→ table starting on page 68	→ table starting on page 72	
<input type="checkbox"/> P1, P2 ... P6				
Mon - Fri				
<input type="checkbox"/> P1, P2 ... P6				
Sat + Sun				
<input type="checkbox"/> P1, P2 ... P6				
Monday, Tuesday ... Sunday	→ table on page 71	→ table starting on page 68	→ table starting on page 72	
<input type="checkbox"/> P1, P2 ... P6				
Reset factory settings	No	No Yes		
Programme name	As selected on Edit menu, e.g. Programme A	Different programme name		

Tab. 6

Heating menu structure		Default setting	Setting range	Personal setting	Description starts on page	
D: Programme D ... F: Programme F	Copy from preset programme	No	No D:Programme D ... F:Programme F (Programme name can be changed)	-	33	
	All days	→ table on page 71	→ table on page 71	→ table on page 73		
	P1, P2 ... P6					
	Mon - Fri					
	P1, P2 ... P6					
	Sat + Sun					
	P1, P2 ... P6					
	Monday, Tuesday ... Sunday					
	P1, P2 ... P6					
	Reset factory settings	No	No Yes			
Programme name	As selected on Edit menu, e.g. Programme D	Different programme name				
View		-	-	-		
A: Programme A ... F: Programme F AM weekday worker PM weekday worker Full weekday worker AM+PM weekday worker Home all day Home all day, early Home all day, late Senior citizens		All days	All days Mon - Fri Sat + Sun Monday, Tuesday ... Sunday	-		
	Parameter		-	-	-	
	Heating levels		-	-	-	
	Comfort	21.0 °C	7.0 °C ... 30.0 °C (higher than Economy)	°C	36	
	Economy	15.0 °C	6.0 °C ... 29 °C (higher than Frost and lower than Comfort)	°C		
	Frost	5.0 °C	5.0 °C ... 28 °C (lower than Economy)	°C		

Tab. 6

6.1.3 MAIN MENU: Domestic hot water

Domestic hot water menu structure	Default setting	Setting range	Personal setting	Description starts on page			
DHW and DHW circulation pump	Separate programmes	Separate programmes As heating programme					
DHW programme ¹⁾	-	-	-				
Edit	-	-	-				
All days	→ table on page 74	→ table on page 74	→ table on page 74	36			
P1, P2 ... P6							
Mon - Fri							
P1, P2 ... P6							
Sat + Sun							
P1, P2 ... P6							
Monday, Tuesday ... Sunday							
P1, P2 ... P6							
Reset factory settings					No	No Yes	
View					-	-	-
All days Mon - Fri Sat + Sun Monday, Tuesday ... Sunday	-	-	-				
DHW circ pump prog ¹⁾	-	-	-				
Edit	-	-	-				
All days	→ table on page 75	→ table on page 75	→ table on page 75	40			
P1, P2 ... P6							
Mon - Fri							
P1, P2 ... P6							
Sat + Sun							
P1, P2 ... P6							
Monday, Tuesday ... Sunday							
P1, P2 ... P6							
Reset factory settings					No	No Yes	
View					-	-	-
All days Mon - Fri Sat + Sun Monday, Tuesday ... Sunday	-	-	-				

Tab. 7

Domestic hot water menu structure		Default setting	Setting range	Personal setting	Description starts on page
Parameter		–	–	–	
	Cylinder temp at heating level Comf.	60 °C	15 °C ... 60 °C	°C	41
	Cylinder temp at heating level Eco	50 °C	15 °C ... 60 °C	°C	
	DHW priority	Priority	Priority Conditional priority		
	DHW circ pump cycles	4 per hour	1 per hour ... 7 per hour	per hour	
Thermal disinfection		–	–	–	
	Operating mode	Manual	Manual Auto		42
	Operating status	Not running	Not running Start now		
		Running	Running Stop		
	Time	01:00 h	00:00 hours ... 23:45 h ²⁾	h	
	Time interval	7 days	1 day ... 30 days	d	

Tab. 7

- 1) Only with “Separate programmes”
- 2) Display subject to the selected “Display format”

6.1.4 MAIN MENU: General settings

General settings menu structure	Default setting	Setting range	Personal setting	Description starts on page
Time and date	–	–	–	43
Time	– : – : – –	00:00 ... 23:59 ¹⁾ (in increments of one hour/minute)	–	
Date	– – . – – . – – – – –	01/01/2005 ... 12/31/2099 (in increments of one day/month/year)	–	
Auto switch between GMT - BST	Yes	Yes No		
Time adjustment	0.0 sec/week	– 60.0 sec/week ... + 60.0 sec/week	sec/week	
Display format	–	–	–	43
Time	12 am/pm	12 am/pm 24h		
Date	DD.MM.YYYY	DD.MM.YYYY or MM/DD/YYYY		
Display contrast	According to factory test	25% ... 75%	%	
Information at top of display	Without ISM or cylinder: Date	Date Required room temp		
	Without ISM but with cylinder: Cylinder temperature	Cylinder temperature Date Required room temp		
	With ISM and cylinder: Solar pump status	Solar pump status Solar yield Required room temp Date Cylinder temperature		
	With ISM but without cylinder: Solar pump status	Solar pump status Solar yield Required room temp Date		
Key lock	Off	Off On		43
Language	English	English Français Polski Deutsch		43

Tab. 8

1) Display subject to the selected “Display format”

6.1.5 MAIN MENU: Solar

Solar menu structure	Default setting	Setting range	Personal setting	Description starts on page
T2: Max. solar cylinder temperature	60 °C	15 °C ... 90 °C	°C	44
Optimizing influence DHW ¹⁾	0 K	0 K (= function off) ... 20 K	K	44

Tab. 9

1) Only available if collector area is set on Expert menu

6.2 Heating program

Main menu: Heating



Set the flow temperature control on the boiler to the maximum required flow temperature.

6.2.1 Timer programmes for heating

Heating programmes control central heating operation. There are three modes for heating operation:

- **Comfort** ☀
- **Economy** ☾
- **Frost** (Frost protection) ❄

-or-

Individual temperature levels:

- **5 °C to 30 °C** in 1 °C increments.

For each of the operating modes, there is a specified room temperature stored on the FR 110 heating controller (→ Section 6.2.2, page 36).

There are a total of six programme spaces (A to F) available for heating programmes. Each heating programme contains the switching times for one week (weekly programme). You can activate one of the heating programmes for each heating circuit.

A time/temperature profile with the specified temperatures for the operating modes

Comfort ☀ / **Economy** ☾ / **Frost** ❄ can be created for the heating programmes A to C.

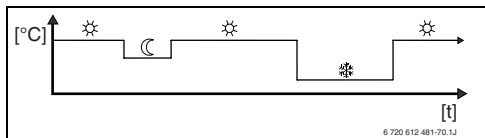

Fig. 11 Example time/temperature profile with operating modes for heating programmes A to C

An individual time/temperature profile with user-defined temperatures can be created for the heating programmes D to F.

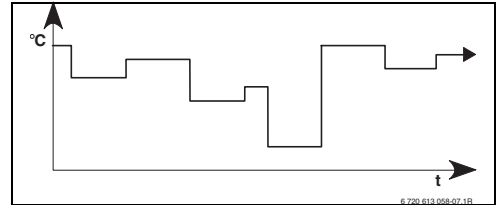

Fig. 12 Example time/temperature profile with user-defined temperatures for heating programmes D to F



Having several stored heating programmes simplifies changing from one heating programme to another, e.g. if your job involves periods when you work different shifts (night shift/day shift), or for holiday periods.

Menu: Heating > Programme

Use this menu to create, change or activate a heating programme for the associated heating circuit in each case.

The heating programmes are only active if the mode selector is set to **auto**.

- **Activate:** Selects and activates the heating programme.

For menu structure and adjustment ranges → page 28.



Menu: Heating > Programme > Edit

Use this menu if you want to adapt a heating programme with user-defined time/temperature profile for the heating circuit.

For menu structure and adjustment ranges → page 28.

Menu: Heating > Programme > Edit > A:Programme A ... F:Programme F

Use this menu to adapt the heating programme of your choice.

- **Copy from preset programme:** Overwrites the selected heating programme with an existing heating programme of your choice.
 - **A:Programme A ... F:Programme F:** Heating programmes with user-defined time/temperature profiles (programme names can be changed, see below).
 - **AM weekday worker ... Senior citizens:** Predefined heating programmes.
- **Reset factory settings:** Resets heating programme to default settings → page 22.
- **Programme name:** Changes name of heating programme using  and . The 18 characters displayed can be individually replaced by selecting the letters and numbers offered.



To enter spaces:



- ▶ When the selected character is shown with a dark background, delete by pressing  (space = _)

For menu structure and adjustment ranges
→ page 28.

Menu: Heating > Programme > Edit > A:Programme A ... C:Programme C > All days

Use this menu to set identical times for every day for the heating programme of your choice.



- **P1, P2 ... P6:** Maximum of six switching points per day and three different operating modes (**Comfort** ☀ / **Economy** ☾ / **Frost** ❄).
- The shortest switching interval is 15 minutes (= 1 segment).
- Deactivate switching points that are not required by deleting them.

- Skip switching points and operating modes that are not to be changed by pressing  or turning  the rotary selector.

For menu structure and adjustment ranges
→ page 28.

Menu: Heating > Programme > Edit > D:Programme D ... F:Programme F > All days

Use this menu to set identical times for every day for the heating programme of your choice.

- **P1, P2 ... P6:** Maximum of six switching points per day with temperatures from **5 °C to 30 °C** in 1 °C increments.
 - The shortest switching interval is 15 minutes (= 1 segment).
 - Deactivate switching points that are not required by deleting them.
 - Skip switching points and operating modes that are not to be changed by pressing  or turning  the rotary selector.

For menu structure and adjustment ranges
→ page 28.

Menu: Heating > Programme > Edit > A:Programme A ... C:Programme C > Mon - Fri

Use this menu to set identical times for the days Monday to Friday for the heating programme of your choice.

- **P1, P2 ... P6:**
For explanation see **A:Programme A ... C:Programme C > All days** above.

For menu structure and adjustment ranges
→ page 28.

Menu: Heating > Programme > Edit > D:Programme D ... F:Programme F > Mon - Fri

Use this menu to set identical times for the days Monday to Friday for the heating programme of your choice.

• **P1, P2 ... P6:**

For explanation see **D:Programme D ... F:Programme F > All days** above.

For menu structure and adjustment ranges
→ page 28.

Menu: Heating > Programme > Edit > A:Programme A ... C:Programme C > Sat + Sun

Use this menu to set identical times for Saturday and Sunday for the heating programme of your choice.

• **P1, P2 ... P6:**

For explanation see **A:Programme A ... C:Programme C > All days** above.

For menu structure and adjustment ranges
→ page 28.

Menu: Heating > Programme > Edit > D:Programme D ... F:Programme F > Sat + Sun

Use this menu to set identical times for Saturday and Sunday for the heating programme of your choice.

• **P1, P2 ... P6:**

For explanation see **D:Programme D ... F:Programme F > All days** above.

For menu structure and adjustment ranges
→ page 28.

Menu: Heating > Programme > Edit > A:Programme A ... C:Programme C > Monday, Tuesday ... Sunday

Use this menu to set different times for individual days in the heating programme of your choice (e.g. **Thursday**: starting the selected operating mode at the same time every Thursday).

• **P1, P2 ... P6:**

For explanation see **A:Programme A ... C:Programme C > All days** above.



If the programme for, say, **Thursday** differs from the other weekdays, the options **All days** and **Mon - Fri** show **---- from --:--** for all settings. In other words there are no common switching points and operating modes for all the days in those groups.

For menu structure and adjustment ranges
→ page 28.

Menu: Heating > Programme > Edit > D:Programme D ... F:Programme F > Monday, Tuesday ... Sunday

Use this menu to set different times for individual days in the heating programme of your choice (e.g. **Thursday**: starting the selected operating mode at the same time every Thursday).

• **P1, P2 ... P6:**

For explanation see **D:Programme D ... F:Programme F > All days** above.



If the programme for, say, **Thursday** differs from the other weekdays, the options **All days** and **Mon - Fri** show **---- from --:--** for all settings. In other words there are no common switching points and operating modes for all the days in those groups.

For menu structure and adjustment ranges
→ page 28.

Menu: Heating > Programme > View

- ▶ Shows switching points and associated operating modes for **All days**, **Mon - Fri**, **Sat + Sun** or the individual day of the week as a segment pattern.

For menu structure and adjustment ranges
→ page 28.

6.2.2 Temperature levels for the operating modes

Menu: Heating > Parameter

Use this menu to permanently set the temperature levels for the 3 operating modes (**Comfort** ☀ / **Economy** ☾ / **Frost** ❄) to suit your personal preferences and your home.

Menu: Heating > Parameter > Heating levels

Use this menu to set the desired room temperature for each of the operating modes:

- **Comfort** ☀ = maximum required temperature (e.g. when the living areas are occupied and the occupants require a comfortable room temperature). Solid segments on the display indicate the period for which the operating mode is active.
- **Economy** ☾ = medium required temperature (e.g. when a lower temperature is sufficient or when the home is empty or everyone is in bed and you do not want the house to cool down too much) Blank segments on the display indicate the period for which the operating mode is active.
- **Frost** ❄ = minimum required temperature (e.g. when the home is empty or everyone is in bed and it is OK for the house to cool down) Consider any pets and plants.



Display of the segments for heating programmes C, D and F (individual temperature profiles) is also dependent on the settings made here.

For menu structure and adjustment ranges
→ page 28.

6.3 DHW programme

Main menu: Domestic hot water



Set the domestic hot water temperature control on the boiler to the maximum required domestic hot water temperature.



If the domestic hot water programme changes from a higher to a lower specified temperature, the water in the cylinder will not immediately cool to the lower temperature, i.e. water at a higher temperature will continue to be available for some time. However, the cylinder will not be reheated until the temperature falls below the new, lower specified temperature.

• **DHW and DHW circulation pump**

You can use this menu option either to ...
... activate your own individual domestic hot water programme (**Separate programmes**)

- or -

... associate the domestic hot water programme with your heating programme (**As heating programme**). That is useful if you frequently switch between different heating programmes. The domestic hot water programme is then automatically adapted to suit.

- **As heating programme** (Automatic mode together with heating programme):

With combination boiler:

Domestic hot water **On** as long as the heating system is in **Comfort** ☀ mode and for 1 hour afterwards (overrun time).
Otherwise hot water **Off**.

With domestic hot water cylinder:

1 hour before the heating system switches to **Comfort** ☀ mode, the cylinder starts heating up to the set domestic hot water temperature (**Cylinder temp at heating level Comf.** ¹⁾). This setting remains active as long as the heating system is in **Comfort** ☀ mode.

If the heating system is in **Economy** ☾ mode, the cylinder is kept at the temperature set for **Cylinder temp at heating level Eco** ¹⁾.

If the heating system is in **Frost** ❄ mode, frost protection is also active for the domestic hot water cylinder (fixed temperature of 15 °C).

With circulation pump for domestic hot water cylinder:

Circulation pump **On** and circulation pump cycles as per setting (→ Section 6.3.4 on page 41) if the heating circuit is running in **Comfort** ☀ mode.

Otherwise circulation pump **Off**.

- **Separate programmes** (independent timer programmes):

Automatic switching between domestic hot water **On** ²⁾ / **Off** ²⁾ or different domestic hot water temperatures ³⁾ and circulation pump **On** / **Off** according to the set programmes.

Circulation pump cycles as per setting (→ Section 6.3.4 on page 41).

For menu structure and adjustment ranges
→ page 30.

1) Setting domestic hot water temperature
→ Section 6.3.4 on page 41

2) Domestic hot water provided by combination boiler

3) Domestic hot water provided by domestic hot water cylinder

6.3.1 Timer programme for domestic hot water with combination boiler

Menu: Domestic hot water > DHW programme

Use this menu if you wish to use a timer programme for the domestic hot water.

The timer programme is only programmable and active if **Domestic hot water > DHW and DHW circulation pump > Separate programmes** is set.

Menu: Domestic hot water > DHW programme > Edit

Use this menu if you wish to adjust a timer programme for the domestic hot water.

- **Reset factory settings:** Resets domestic hot water programme to default settings
→ page 22.

For menu structure and adjustment ranges
→ page 30.

Menu: Domestic hot water > DHW programme > Edit > All days

Use this menu to set identical times for every day for the domestic hot water programme.

- **P1, P2 ... P6:** Maximum of six switching points per day and two different operating modes (**On / Off**).
 - **On:** if the Eco button on the boiler is not lit, domestic hot water is available very quickly on demand (Comfort mode). Solid segments on the display indicate the period for which the operating mode is active.
 - **Off:** the built-in water heater in the boiler is not kept constantly hot (Eco mode); as a result energy is saved. In Eco mode, the hot tap has to be run for a short while before the water becomes hot. Blank segments on the display indicate the period for which the operating mode is active.
 - The shortest switching interval is 15 minutes (= 1 segment).

- Deactivate switching points that are not required by deleting them.

For menu structure and adjustment ranges
→ page 30.

Menu: Domestic hot water > DHW programme > Edit > Mon - Fri

Use this menu to set identical times for the days Monday to Friday for the domestic hot water programme.

- **P1, P2 ... P6:**

For explanation see **All days** above.

For menu structure and adjustment ranges
→ page 30.

Menu: Domestic hot water > DHW programme > Edit > Sat + Sun

Use this menu to set identical times for Saturday and Sunday for the domestic hot water programme.

- **P1, P2 ... P6:**

For explanation see **All days** above.

For menu structure and adjustment ranges
→ page 30.

Menu: Domestic hot water > DHW programme > Edit > Monday, Tuesday ... Sunday

Use this menu to set different times for individual days in the domestic hot water programme.

- **P1, P2 ... P6:**

For explanation see **All days** above.

For menu structure and adjustment ranges
→ page 30.

Menu: Domestic hot water > DHW programme > View

- ▶ Shows switching points and associated operating modes for **All days, Mon - Fri, Sat + Sun** or the individual day of the week as a segment pattern.

For menu structure and adjustment ranges
→ page 30.

6.3.2 Time/temperature programme for domestic hot water (systems with domestic hot water cylinder only)

Menu: Domestic hot water > DHW programme

Use this menu if you wish to use a domestic hot water programme with user-defined time/temperature profile.

The time/temperature programme is only programmable and active if **Domestic hot water > DHW and DHW circulation pump > Separate programmes** is set.

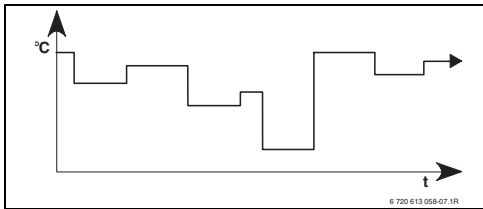

Fig. 13 Example hot water programme with time/temperature profile

For menu structure and adjustment ranges
→ page 30.

Menu: Domestic hot water > DHW programme > Edit

Use this menu if you wish to adjust a timer programme for the domestic hot water.

- **Reset factory settings:** Resets domestic hot water programme to default settings
→ page 22.

For menu structure and adjustment ranges
→ page 30.

Menu: Domestic hot water > DHW programme > Edit > All days

Use this menu to set identical times for every day for the domestic hot water programme.

- **P1, P2 ... P6:** Maximum of six switching points per day with individual temperature levels (**15 °C to 60 °C**).
 - If the temperature measured in the domestic hot water cylinder is below the specified temperature, the cylinder is re-heated.
 - Once the specified temperature is reached (or exceeded), cylinder heating is stopped.
 - The shortest switching interval is 15 minutes (= 1 segment).
 - Deactivate switching points that are not required by deleting them.



The segments on the display show the periods for the following hot water temperature requirements:

- ≥ 50 °C – solid segments
- ≤ 20 °C – no segments
- other – blank segments

For menu structure and adjustment ranges
→ page 30.

Menu: Domestic hot water > DHW programme > Edit > Mon - Fri

Use this menu to set identical times for the days Monday to Friday for the domestic hot water programme.

- **P1, P2 ... P6:**
For explanation see **All days** above.

For menu structure and adjustment ranges
→ page 30.

Menu: Domestic hot water > DHW programme > Edit > Sat + Sun

Use this menu to set identical times for Saturday and Sunday for the domestic hot water programme.

- **P1, P2 ... P6:**

For explanation see **All days** above.

For menu structure and adjustment ranges
→ page 30.

Menu: Domestic hot water > DHW programme > Edit > Monday, Tuesday ... Sunday

Use this menu to set different times for individual days in the hot water programme.

- **P1, P2 ... P6:**

For explanation see **All days** above.

For menu structure and adjustment ranges
→ page 30.

Menu: Domestic hot water > DHW programme > View

- ▶ Shows switching points and associated temperatures for **All days, Mon - Fri, Sat + Sun** or the individual day of the week as a segment pattern.

For menu structure and adjustment ranges
→ page 30.

6.3.3 Timer programme for domestic hot water circulation pump (systems with domestic hot water cylinder only)

The circulation programme specifies when the circulation pump for domestic hot water circulation runs.

Menu: Domestic hot water > DHW circ pump prog

Use this menu if you wish to use a timer programme for the domestic hot water circulation pump.

The timer programme is only programmable and active if **Domestic hot water > DHW and DHW circulation pump > Separate programmes** is set.

Menu: Domestic hot water > DHW circ pump prog > Edit > All days

Use this menu to set identical times for every day for the domestic hot water programme.

- **P1, P2 ... P6:** Maximum of six switching points per day and two different operating modes (**On / Off**).
 - **On:** Circulation pump cycles as per setting (→ Section 6.3.4 on page 41). Solid segments on the display indicate the period for which the operating mode is active.
 - **Off:** The circulation pump is stopped. Blank segments on the display indicate the period for which the operating mode is active.
 - The shortest switching interval is 15 minutes (= 1 segment).
 - Deactivate switching points that are not required by deleting them.

For menu structure and adjustment ranges
→ page 30.

Menu: Domestic hot water > DHW circ pump prog > Edit > Mon - Fri

Use this menu to set identical times for the days Monday to Friday for the domestic hot water programme.

- **P1, P2 ... P6:**
For explanation see **All days** above.

For menu structure and adjustment ranges
→ page 30.

Menu: Domestic hot water > DHW circ pump prog > Edit > Sat + Sun

Use this menu to set identical times for Saturday and Sunday for the domestic hot water programme.

- **P1, P2 ... P6:**
For explanation see **All days** above.

For menu structure and adjustment ranges
→ page 30.

Menu: Domestic hot water > DHW circ pump prog > Edit > Monday, Tuesday ... Sunday

Use this menu to set different times for individual days in the domestic hot water programme.

- **P1, P2 ... P6:**
For explanation see **All days** above.

For menu structure and adjustment ranges
→ page 30.

Menu: Domestic hot water > DHW circ pump prog > View

- ▶ Shows switching points and associated operating modes for **All days, Mon - Fri, Sat + Sun** or the individual day of the week as a segment pattern.

For menu structure and adjustment ranges
→ page 30.

6.3.4 Parameters for domestic hot water (systems with domestic hot water cylinder only)**Menu: Domestic hot water > Parameter**

- **Cylinder temp at heating level Comf.:**
This menu option is only active if **Domestic hot water > DHW programme > As heating programme** is set (→ page 36). This is where you set the desired domestic hot water temperature for your domestic hot water cylinder.
- **Cylinder temp at heating level Eco:**
This menu option is only active if **Domestic hot water > DHW programme > As heating programme** is set (→ page 36). This is where you set the desired reduced domestic hot water temperature for your domestic hot water cylinder.
- **DHW circ pump cycles:**
This menu option is only active if the system has a domestic hot water circulation pump. The circulation pump stops during the circulation pump **Off** phases. This menu option specifies how many times per hour the circulation pump will cycle during the circulation pump **On** phase. With the setting:
 - **1 per hour to 6 per hour**, each circulation pump cycle lasts for 3 minutes.
 - **7 per hour**, the circulation pump runs continuously during the **On** phase.

For menu structure and adjustment ranges
→ page 30.

6.3.5 Thermal disinfection of domestic hot water (systems with domestic hot water cylinder only)

Menu: Domestic hot water > Thermal disinfection

This menu is only active if your domestic hot water is provided by a domestic hot water cylinder. We recommend that you carry out thermal disinfection at regular intervals. For larger domestic hot water systems, there may be a legal requirement for thermal disinfection. If you have a combination boiler, please refer to the guidance in the boiler documentation.



If the thermal disinfection function triggers the safety cut-out on the solar cylinder (HLC) the solar water heating is inactive. The controller indicates a fault (→ Section 9, page 59).



Warning: Risk of scalding

Hot water can cause severe scalding.

- ▶ Only carry out thermal disinfection at times when the system is not normally in use.
- ▶ Inform occupants of the building of the danger of scalding and always monitor the thermal disinfection process.

• **Operating mode:**

- **Auto:** Thermal disinfection starts automatically according to the set starting conditions. The thermal disinfection can be switched on and cancelled manually.
- **Manual:** Thermal disinfection can be started from **Operating status**.

• **Operating status:**

- **Not running:** No thermal disinfection in progress at present. Once-only thermal disinfection can be started by selecting **Start now**.
- **Running:** Thermal disinfection currently in progress. Thermal disinfection can be stopped by selecting **Stop**.
If **Solar sys option E Thermal disinfection** is switched on (→ Section 8.4 on page 54) and thermal disinfection is stopped by selecting **Stop**, a fault is indicated for 5 minutes if the disinfection temperature in the solar cylinder has not been reached (Fault 54, → Section 9.1 starting on page 59).

- **Time:** Starting time for automatic thermal disinfection.
- **Time interval:** Period until next starting time for automatic thermal disinfection.



If you want to use automatic thermal disinfection (e.g. once a week), proceed as follows:

- ▶ Set the time interval to the required period (e.g. 7d, i.e. 7 days).
- ▶ Set the required starting time (e.g. 22:00 hours).
- ▶ Set the operating mode to **Auto on the day** on which you want thermal disinfection to take place.

For menu structure and adjustment ranges
→ page 30.

6.4 General settings

6.4.1 Time, Date and Auto switch between GMT - BST

Menu: General settings > Time and date

Use this menu if you want to correct the date and time.

- **Time:** Resets the time, e.g. if the mains power has been off for more than 12 hours.
- **Date:** see above **Time**.
The day of the week (e.g. **Mo**) is automatically calculated.
- **Auto switch between GMT - BST:** Switches automatic summer/winter time adjustment on or off.
- **Time adjustment:** Sets the adjustment factor for the time. The adjustment is carried out once a week.

Example:

- If the time is out by approximately – 3 minutes a year
- – 3 minutes a year is equal to
 - 180 seconds a year
- 1 year = 52 weeks
- – 180 seconds ÷ 52 weeks
 - = – 3.46 seconds a week
- Corection factor = **+3.5sec/week**

For menu structure and adjustment ranges
→ page 32.

6.4.2 Display formats

Menu: General settings > Display format

Use this menu if you want to customise the display formats to suit your personal preferences.

- **Time:** Select format for time display between **12 am/pm** or **24h**.
- **Date:** Selects either **DD.MM.YYYY** or **MM/DD/YYYY** as date display format (D = number for

day, M = number for month, Y = number for year).

- **Display contrast:** Sets display contrast to between **25%** and **75%**.
- **Information at top of display:** Sets the desired information to be shown on the top line of the basic display.

For menu structure and adjustment ranges
→ page 32.

6.4.3 Key lock



For menu structure and adjustment ranges
→ page 32.

- **Key lock:** Use this menu option to prevent unwanted operation of the button functions, e.g. by children.
 - If a locked button is pressed when the **Key lock** is active and the screen is showing the basic display, an appropriate message appears.



If the mode selector is set to a different mode, it does not become active until the **Key lock** is cancelled.

► To cancel **Key lock**:

Press and hold  and  simultaneously until the relevant message appears.

For menu structure and adjustment ranges
→ page 32.

6.4.4 Language

- **Language:** Use this menu option if you want to set a different language for the display.

For menu structure and adjustment ranges
→ page 32.

6.5 Solar settings

Main menu: Solar

Use this menu if you want to limit the cylinder temperature or optimise the specified domestic hot water temperature and specified flow temperatures based on the available solar energy in your geographical region.

Limiting cylinder temperature

In order to store as much solar energy as possible, a high cylinder temperature is required.

Limiting the cylinder temperature prevents overheating of the domestic hot water. The temperature setting is transmitted by the ISM module during commissioning.



Warning: Risk of scalding if the cylinder temperature is higher than 60 °C.

- ▶ If the cylinder temperature limit is set to > 60 °C, fit a thermostatic mixing valve in the hot water supply pipe.
- ▶ Set the thermostatic mixing valve unit to 60 °C max.

- **T2: Max. solar cylinder temperature:** Set cylinder temperature > 60 °C in systems with hot water cylinder only if hot water outlet temperature is limited by a thermostatic DHW mixing valve.

For menu structure and adjustment ranges
→ page 32.

Solar optimisation

In order to use as much solar energy as possible, the FR 110 heating controller can estimate the expected solar yield over the course of a day and take it into account when controlling the hot water system. The boiler will then not be required to produce as much heat and will use less gas.

For more information for installers
→ Section 8.5.3 on page 56

- **Optimizing influence DHW:** maximum reduction of specified hot water temperature by effect of solar thermal system.

Example:

- Specified hot water temperature = 60 °C
- **Optimizing influence DHW** = 15 K
- Specified hot water temperature for the boiler = 60 °C – 15 K
- Provided there is sufficient solar output available, the maximum reduction is set and the boiler heats the domestic hot water to 45 °C, with the remaining 15 K being provided by the solar contribution.



Optimizing influence DHW does not start until a calibration phase of at least 30 days has been completed after commissioning of the solar thermal system. In that period, the FR 110 heating controller “learns” what level of solar yield is possible.

For menu structure and adjustment ranges
→ page 32.

7 Viewing information

Menu:INFO

This menu allows you to view a variety of system information.

Detailed instructions on navigating through the menu structure are provided in Section 5.2 starting on page 18.



The menu options are only shown if the system components are present and/or active. Some menu options are not shown because they are switched off by a setting for another menu option.

INFO menu overview

The table below provides

- an overview of the menu structure (column 1). The menu level is indicated by different shades of grey. For example, the menus **Boiler** and **Heating system** are at the same level.
- an overview of the various display options (column 2).
- descriptions of the individual information items (column 3).



INFO menu structure	Display (example)	Description
Boiler	–	–
Heating mode possible	Yes No	Shows whether boiler is ready for operation.
Current CH flow temperature	55.0 °C	Current boiler flow temperature.
Burner	On Off	Burner status.
Heating pump	On Off	Status of pump in the boiler.
Maximum CH flow temperature	75.0 °C	Maximum flow temperature set on the boiler.
Maximum domestic hot water temperature	60.0 °C	Maximum domestic hot water temperature set on the boiler.
Service required	Yes No	Shows whether a boiler service/inspection is due.

Tab. 10

Viewing information

INFO menu structure	Display (example)	Description
Heating system	–	–
Operating mode	Auto – Comfort Auto – Economy Auto – Frost Comfort Economy Frost Holiday – Auto Holiday – Comfort Holiday – Economy Holiday – Frost	Current operating mode or special mode
Required room temp	25.0 °C	Required room temperature
Current room temperature	22.0 °C	Room temperature measured at the controller.
Required CH flow temperature	75.0 °C	Flow temperature calculated and required by controller.
Current CH flow temperature	47.0 °C	Measured flow temperature.
Heating pump	On Off	Status of heating pump.
Domestic hot water	–	–
Operating mode	Immediate DHW Auto On Auto Off Holiday – Auto Holiday On Holiday Off	Current operating mode or special mode for hot water with combination boiler.
	Immediate DHW Thermal disinfection Auto Holiday – Auto Holiday 15 °C	Current operating mode or special mode for hot water cylinder.
Required DHW temperature	60.0 °C	Hot water temperature required by controller.
Current DHW temperature	40.0 °C	Current measured hot water temperature.
Domestic hot water status	Running Off	Current status of hot water system.
Last thermal disinfection	Completed Cancelled Running	Status of last thermal disinfection.
Customer service ¹⁾	–	–
Phone number	(Telephone number)	Telephone number of heating engineer (system installer).
Name	(Name)	Name of heating engineer (system installer).

Tab. 10

INFO menu structure	Display (example)	Description
Solar	–	–
Standard system	–	Menu for basic system component of solar thermal system.
T1: Temperature of collector group 1	80.0 °C	Temperature measured by collector temperature sensor (T_1).
T2: Temp at bottom of solar cylinder	55.7 °C	Temperature measured by bottom cylinder temperature sensor (T_2).
SP: Collector grp 1 solar pump status	Running Off	Status of solar pump (SP).
Collector group 1 shutdown	Yes No	Shows whether safety shutdown of the solar pump (SP) due to overheating of the collectors (T_1) has occurred.
Solar cylinder status	Fully charged Partially charged	Charge status of solar cylinder.
SP: Coll grp 1 solar pump running time	12463 h	Hours of duty of the solar pump (SP) since commissioning.
Thermal disinfection	–	Menu for thermal disinfection part of the system.
PE: Therm disinfect pump status	Running Off	Status of thermal disinfection pump (PE).
Solar optimisation ²⁾	–	Menu for solar-assisted optimisation of conventional heating system.
Solar yield in last hour	120 Wh	Solar energy yield in the last hour (a figure is only shown if correct parameters have been set on the Solar optimisation menu, →Section 8.5.3 on page 56).
Solar yield today	2.38 kWh	Solar energy yield for the current 24 hour period.
Solar yield overall	483.6 kWh	Total solar energy yield since commissioning.
DHW temperature reduced by	4.7 K	Current reduction of the specified hot water temperature required by the boiler as a result of the available solar energy. Does not start until at least 30 days after commissioning.
Faults	40 Solar system 03 FR 110 EA Boiler ...	List of current faults. More detailed information can be obtained by selecting with the rotary selector  and then pressing the rotary selector  to confirm.

Tab. 10

- 1) Only available if a name or phone number has been entered on Expert menu.
- 2) Only available if collector area is set on Expert menu.

8 INSTALLER SETTINGS menu settings (for installers only)



The **INSTALLER SETTINGS** menu is intended only for installers.

- ▶ To open **INSTALLER SETTINGS**: press and hold  for approx. 3 seconds.

Detailed instructions on navigating through the menu structure, programming, deleting settings and resetting to the default settings are provided in Section 5.2 starting on page 18.

8.1 INSTALLER SETTINGS menu summary and settings

The tables set out below provide

- an overview of the menu structure (column 1).
The menu level is indicated by different shades of grey.
For example, on the menu **Solar sys parameters**, the submenus **1. Standard system** and **Solar optimisation** are at the same level.
- an overview of the default settings (column 2), e.g. for the purposes of resetting individual menu options to the default.
- an overview of the adjustment ranges of the individual menu options (column 3).
- space for making a note of your personal settings (column 4).
- references to the detailed descriptions of the individual menu options (column 5).



The menu options are only shown if the system components are present and/or active. Some menu options are not shown because they are switched off by a setting for another menu option.

- ▶ Always set or skip menu options in order. In that way, subsequent menu options will be automatically adjusted or not shown.

8.1.1 INSTALLER SETTINGS: System configuration

System configuration menu structure	Default setting	Setting range	Personal setting	Description starts on page
Connection type	–	–		52
Start automatic system configuration	No	No Yes		
Domestic hot water configuration	Cyl conn to boiler	No Combi boiler Cyl conn to boiler		
DHW circulation pump	No	No Present		
CH system configuration	Unmixed without IPM	Unmixed without IPM Unmixed with IPM Mixed		
ISM 1	No	No Present		
ISM 2	No	No Present		

Tab. 11

8.1.2 INSTALLER SETTINGS: Heating parameters

Heating parameters menu structure	Default setting	Setting range	Personal setting	Description starts on page
Calibrate room temperature sensor	0.0 K	– 3.0 K ... 3.0 K	K	53
Adjustment factor I	40%	0% ... 100%	%	
Amplification factor V	80%	40% ... 100%	%	
Heat-up optimisation	No	No Yes		
Maximum CH flow temperature	75 °C	30 °C ... 85 °C	°C	
Mixer running time	140 s	10 s ... 600 s	s	

Tab. 12

8.1.3 INSTALLER SETTINGS: Solar system config

Solar system config menu structure	Default setting	Setting range	Personal setting	Description starts on page
Solar sys option E Thermal disinfection	No	No Yes		54

Tab. 13

INSTALLER SETTINGS menu settings (for installers only)

8.1.4 INSTALLER SETTINGS: Solar sys parameters

Solar sys parameters menu structure	Default setting	Setting range	Personal setting	Description starts on page
1. Standard system	–	–	–	
SP: ON temperature difference	8 K	3 K ... 20 K (not lower than "SP: OFF temperature difference" +1 K)	K	55
SP: OFF temperature difference	4 K	2 K ... 19 K (not higher than "SP: ON temperature difference" – 1 K)	K	
T2: Max. solar cylinder temperature	60 °C	15 °C ... 90 °C	°C	
Maximum collector temperature	120 °C	100 °C ... 140 °C	°C	
SP: Collector grp 1 pump mode	Auto	Auto Manual On Manual Off		
PE: Therm disinfect pump mode	Auto	Auto Manual On Manual Off		54
Solar optimisation				
Collector group 1 area	0.0 m ²	0.0 m ² ... 150.0 m ²	m ²	56
Collector group 1 type	Flat plate collector	Flat plate collector Vac tube collector		
Climate zone	90	0 ... 255		
Optimizing influence DHW	0 K	0 K (= function off) ... 20 K	K	
Run solar system	No	No Yes		55

Tab. 14

8.1.5 INSTALLER SETTINGS: Fault history

Fault history menu structure	Default setting	Setting range	Personal setting	Description starts on page
01/01/2006 16:11 Fault EA (example of last fault)	–	–	–	58
25/09/2005 18:45 FAULT 44 - IPM IDENT. 10 (up to maximum of 19 past faults)	–	–	–	

Tab. 15

8.1.6 INSTALLER SETTINGS: Cust service address

Cust service address menu structure	Example	Setting range	Personal setting	Description starts on page
Telephone number	012345 6789	Max. 20 characters		58
Name	Heating installer	Max. 20 characters		

Tab. 16

8.1.7 INSTALLER SETTINGS: System info

System info menu structure	Example	Setting range	Personal setting	Description starts on page
Installation date	10/22/2005 (activated on commissioning)	-	-	58
Boiler part number	7 777 777 777 (data from boiler)	-	-	
Boiler date of manufacture	06/27/2005 (data from boiler)	-	-	
Controller part number and model	7 777 777 777 FR 110 (fixed factory setting)	-	-	
Controller date of manufacture	06/27/2005 (fixed factory setting)	-	-	
Controller software version	JF11.12 (fixed factory setting)	-	-	

Tab. 17

8.2 Configuring the heating system

Installer settings: System configuration



An example system configuration is shown in Section 2.5 on page 11.

Use this menu if you want to configure the system automatically or manually, e.g. when commissioning or making changes to the system.

- **Start automatic system configuration** for starting automatic configuration.
- **Domestic hot water configuration** for configuring the domestic hot water system manually.
- **CH system configuration** for configuring the heating system manually.
- **DHW circulation pump**: This menu option is only active if the domestic hot water system has a domestic hot water circulation pump.

When first commissioning a heating system, proceed as follows:

- ▶ Start automatic configuration.
 - ▶ Check the other menu options under **System configuration** and, if necessary, adjust to suit the present system.
-



The heating system's solar thermal system must be configured manually (→ Section 8.4, page 54). Automatic configuration of the heating system does not configure the solar system.

For menu structure and adjustment ranges
→ page 49.

8.3 Parameters for heating

Installer settings: Heating parameters



Set the flow temperature control on the boiler to the maximum required flow temperature.

Use this menu if you want to set the parameters for the heating system.

- **Calibrate room temperature sensor:**

- Position a precision instrument near FR 110. The precision instrument must not transfer any heat to the FR 110.
- Keep away from heat sources such as sunlight, body heat, etc. for 1 hour.
- Adjust the displayed room temperature correction value.

- **Adjustment factor I**

The **Adjustment factor I** is the rate at which a constant room temperature control deviation is corrected.

- ≤ **40%**: Set a lower factor to achieve minimal room temperature overshoot by more gradual correction.
- ≥ **40%**: Set a higher factor to achieve faster correction by a greater room temperature overshoot.

- **Amplification factor V:**

Subject to changes in room temperature, the **Amplification factor V** influences the heat demand.

- ≤ **80%**: Set a lower factor to reduce the influence on the heat demand. The selected room temperature is reached more slowly with only minimal overshoot.
- ≥ **80%**: Set a higher factor to increase the influence on the heat demand. The selected room temperature is reached quickly with a tendency to overshoot.

- **Heat-up optimisation:**

- **No:** The heating programme contains only switching times for the heating system.
- **Yes:** The heating programme contains times for the desired room temperatures. The controller shifts the switching points for the heating automatically. When doing so, it is guided by the heating times required on previous days. In that way the controller is able to take account of seasonal outside temperature fluctuations. While the modes **Economy** ☾ / **Frost** ❄ are active, the conditions must remain constantly the same for the "control" room: Keep the same doors closed. Keep windows closed wherever possible. Heat the same rooms. Do not adjust or cover over radiators or valves. → More information can be found in Section 10 on page 64.



If those conditions can not be maintained for several days:

- ▶ Operate the controller without heat-up optimisation.

- **Maximum CH flow temperature:**

Set the **Maximum CH flow temperature** to suit the heating system.

- **Mixer running time:**

Set the **Mixer running time** to suit the running time of the mixer positioner motor used.

8.4 Configuring the solar thermal system



The heating system's solar thermal system has to be configured manually. Automatic configuration of the heating system (→ Section 8.2, page 52) does not configure the solar system.

Installer settings: Solar system config



An example system configuration is shown in Section 2.5 on page 11. Other examples can be found in the instructions for the ISM or the planning documents.

Use this menu if you want to set the thermal disinfection function for the solar thermal system.

- **Solar sys option E Thermal disinfection** for thermal disinfection

For menu structure and adjustment ranges
→ page 49.

8.5 Parameters for solar thermal system



Fill and bleed the solar thermal system according to its documentation and prepare it for commissioning as described this Section.

Installer settings: Solar sys parameters

The default parameter settings on this menu are suitable for many common system dimensions. Use this menu if you want to finely adjust the parameters to suit the installed solar thermal system.

- **PE: Therm disinfect pump mode:** Use this menu option to select the pump (PE) mode for thermal disinfection.
 - **Auto:** Automatically controlled operation according to the set parameters.
 - **Manual On:** Switches the pump permanently on (e.g. for function test when commissioning).
 - **Manual Off:** Switches the pump permanently off (e.g. for servicing work on the pump without having to interrupt heating operation).

For menu structure and adjustment ranges
→ page 50.



The designations of the pumps and the temperature sensors, e.g. (PE) or (T1), are also used in the ISM installation instructions.

8.5.1 Commissioning the solar thermal system

Installer settings: Solar sys parameters

Before commissioning the solar thermal system you must:

- ▶ Fill and bleed the solar thermal system.
- ▶ Check the parameters for the solar thermal system and, if necessary, finely adjust them to suit the installed system.
- **Run solar system:** Use this menu option to commission the solar thermal system.
 - **Yes:** Solar thermal system is active. The ISM control outputs are enabled for automatic control purposes.
 - **No:** Solar thermal system is not active. The ISM control outputs are disabled for automatic control purposes but can be switched on manually.

For menu structure and adjustment ranges
→ page 50.

8.5.2 Parameters for the standard solar thermal system

Menu: Solar sys parameters > 1. Standard system

Use this menu to set the parameters for the solar thermal system if you are using it to provide domestic hot water.

- **SP: ON temperature difference:** Use this menu option to set the cut-in temperature differential for the solar pump (SP).
If the difference between the collector temperature (T_1) and the solar cylinder temperature (T_2) rises above the set figure, the solar pump (SP) is switched on.
- **SP: OFF temperature difference:** Use this menu option to set the cut-out temperature differential for the solar pump (SP).
If the difference between the collector temperature (T_1) and the solar cylinder tempera-

ture (T_2) drops below the set figure, the solar pump (SP) is switched off.

- **T2: Max. solar cylinder temperature:** For a detailed description of **T2: Max. solar cylinder temperature**, → page 44.
- **Maximum collector temperature:** Use this menu option to set the maximum temperature at the collector temperature sensor (T_1).
If the temperature detected at the collector sensor (T_1) rises above the set figure, operation of the solar pump (SP) is disabled until the temperature drops back below the set figure.



At temperatures above 140 °C and system pressures < 4 bar, the heat transfer fluid in the collector evaporates. The solar pump remains disabled until the collector has cooled to a temperature at which there is no more vapour in the solar circuit.

- **SP: Collector grp 1 pump mode:** Use this menu option to set the operating mode for the solar pump (SP).
 - **Auto:** Automatically controlled operation according to the set parameters.
 - **Manual On:** Switches the pump permanently on (e.g. for bleeding the solar system when commissioning).
 - **Manual Off:** Switches the pump permanently off (e.g. for servicing work on the solar system without having to interrupt heating operation).

For menu structure and adjustment ranges
→ page 50.

8.5.3 Parameters for solar optimisation

Solar optimisation is performed automatically according to the available solar output. Calculation of the solar output requires specification of the installed collector area, the collector type and the climate zone in which the system is installed.

Menu: Solar sys parameters > Solar optimisation

Use this menu to set the parameters for solar optimisation.

- **Collector group 1 area:** Use this menu option to set the installed collector area for collector group 1.

Collector type	Gross area per collector in m ²
FK 210	2.1
FK 240	2.4
FK 260	2.6
VK 180	1.8
FKT-1	2.4
FKC-1	2.4
FKB-1	2.4

Tab. 18 Gross collector areas

- **Collector group 1 type:** Use this menu option to set the installed collector type for collector group 1.
- **Climate zone:** Use this menu option to set the climate zone number for the geographical region in which the system is located.
 - Find the location of your system on the climate zones map (→ Fig. 14) and enter the climate zone number.
 - If your location is not shown on the map, leave the number as it is (default setting is 90).
- **Optimizing influence DHW:** This parameter can also be set on the main menu under **Solar**. A detailed description can be found on page 44.

For menu structure and adjustment ranges → page 50.

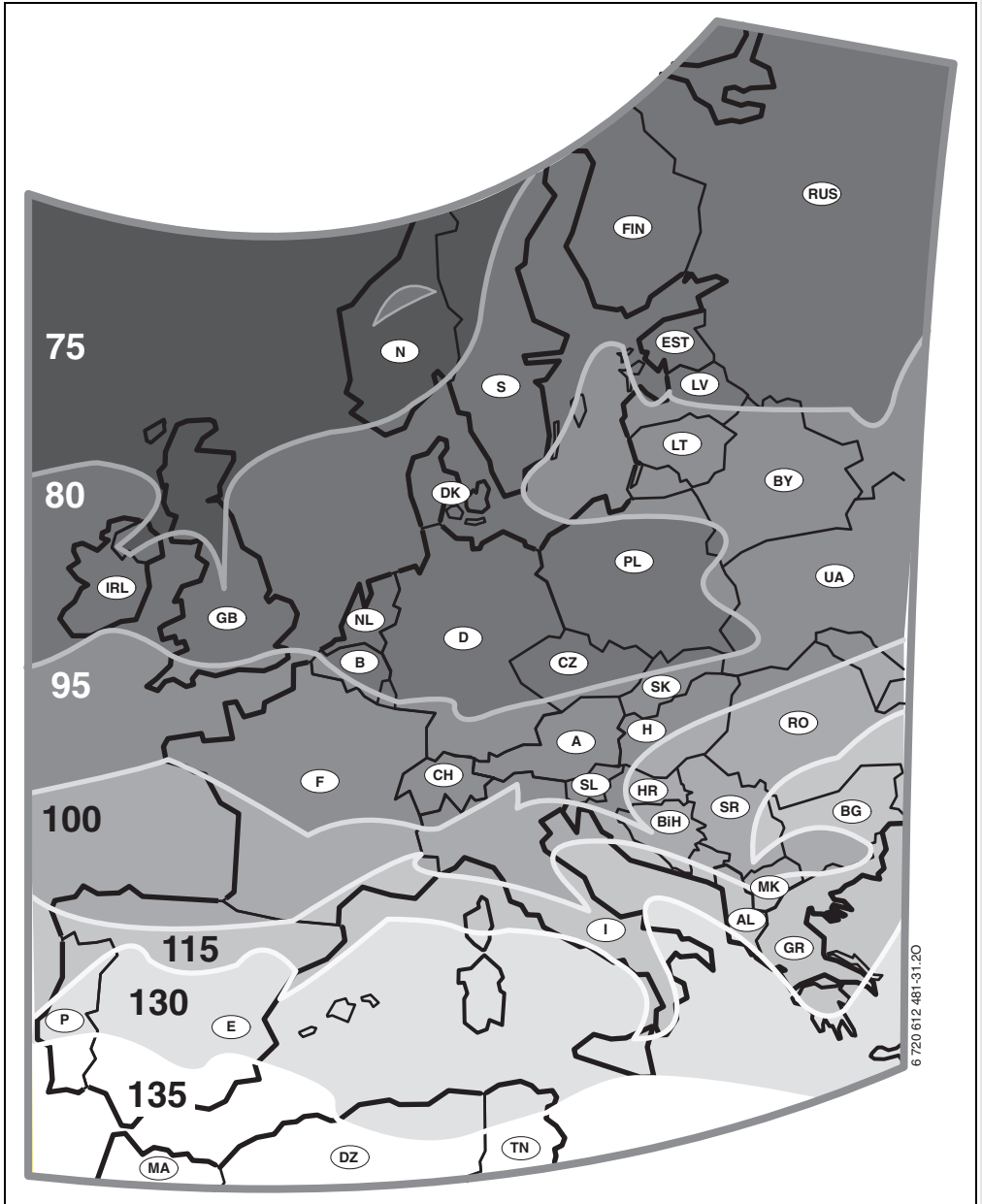

Fig. 14 Map of climate zones in Europe

8.6 Fault history

Installer settings: Fault history

Installers can use this option to view the last 20 faults that have occurred on the system (fault date, source, code and description). The faults shown first may still be active.

For menu structure → page 50.

8.7 Viewing and entering the customer service address

Installer settings: Cust service address

- **Phone number:** The installer can enter the phone number to call for customer service here.
- **Name:** The installer can enter the address of the heating installer responsible for customer service here.



To enter spaces:

- ▶ When the selected character is shown with a dark background, delete by pressing  (space = _)

For menu structure and adjustment range
→ page 50.

8.8 Viewing system information

Installer settings: System info

Shows a variety of system information:

- **Installation date**
(automatically activated on commissioning)
- **Boiler part number**
(fixed setting from boiler)
- **Boiler date of manufacture**
(fixed setting from boiler)
- **Controller part number and model**
(fixed factory setting)
- **Controller date of manufacture**
(fixed factory setting)
- **Controller software version**
(fixed factory setting)

For menu structure → page 51.

9 Troubleshooting

BUS device faults are indicated.

If the controller shows Fault 12, the cylinder temperature is so high that the cylinder HLC has tripped.

- ▶ Reset the HLC.

If the appliance frequently cuts out in this way,

- ▶ Telephone your approved installer or Customer Service for assistance, providing details of the fault and the appliance.

A fault on the boiler (e.g. Fault EA) is shown on the controller display together with a corresponding message.

- ▶ Contact your installer.



For installer:

- ▶ Rectify the fault in accordance with the details in the boiler documentation.

9.1 Troubleshooting using the display (for installers only)

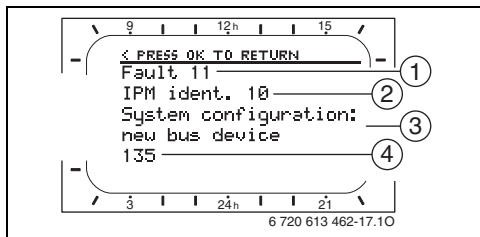

Fig. 15 Fault display

- 1 Fault number
- 2 BUS device which detected the fault and reported it to the controller
- 3 Description of fault
- 4 Code or additional information about fault

The current fault is indicated on the controller:

- ▶ Identify the BUS device affected by the current fault. The fault can only be rectified on the BUS device from which the fault originates.

Information displayed (→ items 1, 3 and 4 in Fig. 15)			
Text	Code	Cause	Remedy (by installer)
Fault 01 BUS communication fault	200	Boiler no longer reporting.	Check BUS device, BUS connection and repair circuit break if necessary.
	201	Incorrect BUS subscriber connected.	Identify and replace incorrect BUS device.
Fault 02 Internal fault	40	Incorrect module type detected.	Replace IPM.
	100	ISM not responding.	Check BUS connection and repair circuit break if necessary.

Tab. 19

Information displayed (→ items 1, 3 and 4 in Fig. 15)			
Text	Code	Cause	Remedy (by installer)
Fault 02 Internal fault Some parameters reset to factory settings due to EEPROM problem	205	Some parameters reset to default.	Check parameter settings and readjust them as necessary. Identify faulty controller and replace.
Fault 02 Internal fault FR110 can no longer control the CH system	255	FR 110 can no longer control the heating system.	Identify faulty controller and replace.
Fault 03 Room temp sensor faulty	20	There is a circuit break on the room temperature sensor built into the FR 110.	Identify faulty controller and replace.
	21	There is a short circuit on the room temperature sensor built into the FR 110.	
Fault 11 System configuration: new BUS device New ISM detected. Power up all ISMs simultaneously and start automatic system configuration.	131 132	New ISM detected.	Power up all ISMs simultaneously and start automatic system configuration.
Fault 12 System configuration: BUS device missing ISM1 not detected. Check connection.	170 171	HLC has tripped or is faulty.	Check HLC. Check solar parameter T2 (→ Section 6.5, page 44). Is thermal disinfection active?
		ISM1 no longer detected despite having been configured.	Check connection.
Fault 13 System configuration: BUS device changed or replaced Check system configuration for DHW or start automatic system configuration.	157	BUS device changed or replaced.	Check system configuration for hot water system or start automatic system configuration.
Fault 13 System configuration: BUS device changed or replaced Check system configuration for heating circuit x and connections on IPM for heating circuit x.	159	BUS device changed or replaced.	Check system configuration for heating circuit x.
Fault 14 System configuration: incompatible BUS device DHW controlled by boiler. IPM control of DHW has no effect.	117	Incompatible BUS device:	Identify incompatible BUS device and remove from the system.
Fault 14 System configuration: incompatible BUS device IPM for cylinder must be set to identification 3 or higher.	118 119	Incompatible BUS device:	Set IPM for cylinder to coding 3 or higher.

Tab. 19

Information displayed (→ items 1, 3 and 4 in Fig. 15)			
Text	Code	Cause	Remedy (by installer)
Fault 19 Unable to save parameter settings	202	BUS device is configured but not available at present.	Check system layout, check system configuration, modify if necessary and set parameter again.
Fault 33 Temperature sensors incorrectly connected	22	A temperature sensor is connected to the IUM.	Remove the temperature sensor and insert a coding plug if necessary.
Fault 40 Temperature sensor T1 on collector group 1 faulty	101	Short circuit on the sensor lead (T ₁).	Check temperature sensor (T ₁) and replace if necessary.
	102	Break in the sensor lead (T ₁).	
Fault 41 Temperature sensor T2 at bottom of solar cylinder faulty	103	Short circuit on the sensor lead (T ₂).	Check temperature sensor (T ₂) and replace if necessary.
	104	Break in the sensor lead (T ₂).	
Fault 50 Solar pump jammed or air in system	121	Solar pump (SP) sticking due to physical blockage.	Unscrew and remove the slotted screw on the pump head and use a screwdriver to release the pump shaft. Do NOT strike the pump shaft with the screwdriver.
		Air in solar thermal system.	Bleed solar system and top up with heat transfer fluid if necessary.
Fault 51 Incorrect temperature sensor type connected	122	Collector temperature sensor type used as cylinder temperature sensor (T ₂).	Use correct type of temperature sensor. → Technical data in ISM installation instructions.
	123	Cylinder temperature sensor type used as collector temperature sensor (T ₁)	
	132	Temperature sensor type PTC 1000 used as cylinder temperature sensor (T ₂).	
	133	Temperature sensor type PTC 1000 used as collector temperature sensor (T ₁).	
Fault 52 Temperature sensors reversed	124	Temperature sensors (T ₁ and T ₂) reversed.	Check the temperature sensors and swap the connections if necessary.
Fault 53 Temperature sensor fitted in wrong location	125	Collector temperature sensor (T ₁) fitted on collector array inlet.	Fit collector temperature sensor (T ₁) close to collector array outlet.

Tab. 19

Troubleshooting

Information displayed (→ items 1, 3 and 4 in Fig. 15)			
Text	Code	Cause	Remedy (by installer)
Fault 54 Temperature for thermal disinfection not reached in solar cylinder	145	Maximum temperature for solar cylinder too low.	Set higher maximum temperature for solar cylinder. → Limiting cylinder temperature, page 44
		Delivery rate of disinfection pump (PE) too low.	Set higher pump speed on disinfection pump (PE) or, if possible, open flow restrictor more.
		Thermal disinfection cancelled manually before the required temperature was reached in the solar cylinder.	This is not a fault. Message is shown only for 5 minutes.
Fault 55 Solar system not yet commissioned	146	Solar system is not yet in operation.	Fill, bleed and prepare the solar thermal system for commissioning according to its documentation. Then start up the solar system.
Fault 56 At least one pump/valve in manual mode	147	Pump (SP) in manual mode.	Reset parameters for pump or valve to "Auto".
Fault 59 Mass flow rate in solar system too high/low.	201	Mass flow rate in solar system for collector group 1 is too high.	Set mass flow in solar system correctly (e.g. increase/decrease pump speed) and if necessary open or close flow restrictor more on solar station. Guide figure: 20 - 40 kg/m ² of collector area per hour. Check setting for collector area, type and climate zone on Solar optimisation menu.
	202	Mass flow rate in solar system for collector group 1 is too low.	

Tab. 19

9.2 Troubleshooting without using display

Fault	Cause	Remedy
Required room temperature not achieved.	Thermostatic valve(s) set too low.	Set thermostatic valve(s) higher.
	Flow temperature controller on the boiler set too low.	Set the flow temperature controller higher.
		Reduce influence of solar optimisation if necessary.
	Air in the heating system.	Bleed radiators and vent the heating system.
	Holiday key on the boiler enabled.	Disable the holiday key on the boiler.
Required room temperature greatly exceeded.	Radiators become too hot.	Set thermostatic valve(s) lower. Set Heating levels for "Comfort" lower.
	FR 110 installed in an unfavourable location, e.g. external wall, near windows, in a draught,	Select a better location for FR 110 and ask your heating engineer to reposition it.
Excessive room temperature fluctuations.	Temporary influence of external heat on the room, e.g. through radiant energy from the sun, lighting, TV, fireplace etc.	Select a better location for FR 110 and ask your heating engineer to reposition it.
Temperature rises instead of falling.	Clock time incorrectly set.	Check time setting.
Room temperature too high during "Economy" and/or "Frost" mode.	The building retains a lot of heat.	Set an earlier switching time for "Economy" and/or "Frost".
Incorrect or no control.	BUS connection or BUS subscriber faulty.	Ask your heating engineer to check the BUS connection against the wiring diagram and correct it if required.
Controller can only be set to automatic mode.	Mode selector faulty.	Have FR 110 replaced by your heating engineer.
Hot water cylinder does not heat up.	Hot water temperature control on boiler set too low.	Set hot water temperature control higher. Reduce influence of solar optimisation if necessary.
	Flow temperature controller on the boiler set too low.	Turn the flow temperature control on the boiler clockwise as far as it will go.
	Hot water programme fault.	Check/correct programme.
	Incorrect System configuration for hot water system.	Correct the configuration to match the hot water system connected.
Heating on during the night.	Heat-up optimisation starts the heating early so that the home reaches the desired room temperature by the set time.	Set a later time for the desired room temperature.
		Switch off heat-up optimisation.

Tab. 20

If the fault persists:

- ▶ Call the authorised installer or customer service and inform them of the fault, quoting the controller details (from the identification plate inside the flap).

Appliance details

Type:.....

Order number:.....

Date of manufacture (FD...):.....

10 Tips on saving energy

- The temperature of the room the FR 110 is installed in controls the overall temperature of the property. Any radiator fitted within the same room must not have a thermostatic radiator valve (TRV) fitted and should be adjusted by the installer. The FR 110 should not be fitted in a living space or a room with supplementary heating.
- All other rooms should have thermostatic radiator valves (TRV) fitted.
- Make effective use of the temperature levels and switching points by setting them to suit the preferences of the occupants.
 - **Comfort** ☼ = Comfortable living environment
 - **Economy** ☾ = Active living environment
 - **Frost** ❄ = Away from home or asleep.
- Much energy can be saved by reducing the room temperature via economy phases. Reducing the room temperature by 1 K (°C) enables up to 5% energy to be saved. It is not recommended to let the room temperature of heated rooms fall below +15 °C during the daytime, otherwise the cooled-down walls continue to radiate cold and the room temperature rises higher, leading to higher energy consumption than if an even heat supply is applied.
- Good thermal insulation of the building: the set temperature for **Economy** is never reached. Nevertheless energy is being saved as the heating system stays off. In that case set the switching point for **Economy** to an earlier time.

- Don't keep windows slightly open for ventilation. This leads to a constant extraction of heat from the room without noticeably improving the ambient air in the room.
- Vent briefly but intensively (open window fully).
- When ventilating, turn off the thermostatic valve or set the mode selector to **Frost**.
- Make effective use of the temperature levels and switching points for the hot water by setting them to suit the preferences of the occupants.

If heat-up optimisation is switched on:

- To make best use of heat-up optimisation, set the times for heating up to the temperature levels for **Economy** or **Comfort** as late as possible.
- The heat-up optimisation function learns the conditions in the “control” room
→ Section 8.3 on page 53.
The first time heat-up optimisation is used, there may be significant temperature differences. During the initial learning phase, do not change the setting before heating up is complete. After a few days, the learning process will have advanced and the control accuracy will improve.
- Set the temperature for **Economy** or **Frost** as low as possible.
- During **Economy** or **Frost** the “control” room conditions must remain constantly the same
→ Section 8.3 on page 53.
If the conditions change, it can take several days for the heat-up optimisation to adapt to the new conditions.

- If the home is not heated for an extended period, e.g. over the weekend, the rooms may cool down to such an extent that the boiler can not bring them up to the required temperature by the specified time (time for boiler switch-on maximum of 6 hours before the set time for **Economy** or **Comfort**). In that case, bring the time forward by an appropriate amount.
- Only charge the hot water cylinder outside the heat-up period, e.g. allow 30 minutes after the heating start time.
- If the radiators become unpleasantly hot, the maximum flow temperature should be reduced accordingly on the boiler.

Solar optimisation

Activate the **Optimizing influence DHW** on the FR 110 by setting a figure of between 1 K and 20 K → Section 6.5 on page 44. If the influence of the **Optimizing influence DHW** is too great, reduce the setting a small amount at a time.

11 Environmental protection

Environmental protection is a fundamental corporate strategy of the Bosch Group.

The quality of our products, their economy and environmental safety are all of equal importance to us and all environmental protection legislation and regulations are strictly observed.

We use the best possible technology and materials for protecting the environment taking account of economic considerations.

Packaging

Where packaging is concerned, we participate in country-specific recycling processes that ensure optimum recycling.

All packaging materials are environmentally compatible and can be reused.

Old appliances

Used appliances contain materials that should be recycled.

The components are easy to separate and the plastics carry identification markings. This allows the sorting out of the various assemblies for appropriate recycling or disposal.

12 Commissioning log for the heating system

Customer/System operator:	System installer:
Date commissioned:	FD (Date of manufacture):
Solar system <input type="checkbox"/> Solar options: E <input type="checkbox"/>	Domestic hot water systems: <input type="checkbox"/> : Combination boiler <input type="checkbox"/> : Cylinder connected to boiler
The following work has been carried out	
Water circulation systems checked <input type="checkbox"/> Remarks:	
Electrical connections checked <input type="checkbox"/> Remarks:	
Automatic configuration completed <input type="checkbox"/> Remarks:	
Domestic hot water system configured <input type="checkbox"/> Remarks:	
Solar system configured <input type="checkbox"/> and commissioned <input type="checkbox"/> Remarks:	
Appliance function checked <input type="checkbox"/>	
Customer/system operator instructed how to operate the appliance <input type="checkbox"/>	
Appliance documentation handed over <input type="checkbox"/>	
<p>Signature of system installer and date:</p>	

Tab. 21





















































































13 Individual timer programme settings

The default settings and personal settings for the timer programmes are summarised below.

















































13.1 Heating programme for heating system

How to set the heating programmes is described in Section 6.2 on page 33.

Ready-made heating programmes (for copying)

	P1		P2		P3		P4		P5		P6	
	  		  		  		  		  		  	
AM weekday worker												
Mo - Th		06:00		08:00		12:00		22:00 ¹⁾	-	-	-	-
Fr		06:00		08:00		12:00		23:30 ¹⁾	-	-	-	-
Sa		07:00		23:30 ¹⁾	-	-	-	-	-	-	-	-
Su		08:00		22:00 ¹⁾	-	-	-	-	-	-	-	-
PM weekday worker												
Mo - Th		07:00		12:00		17:00 ¹⁾		22:00 ¹⁾	-	-	-	-
Fr		07:00		12:00		17:00 ¹⁾		23:30 ¹⁾	-	-	-	-
Sa		07:00		23:30 ¹⁾	-	-	-	-	-	-	-	-
Su		08:00		22:00 ¹⁾	-	-	-	-	-	-	-	-
Full weekday worker												
Mo - Th		06:00		08:00		17:00 ¹⁾		22:00 ¹⁾	-	-	-	-
Fr		06:00		08:00		17:00 ¹⁾		23:30 ¹⁾	-	-	-	-
Sa		07:00		23:30 ¹⁾	-	-	-	-	-	-	-	-
Su		08:00		22:00 ¹⁾	-	-	-	-	-	-	-	-
AM+PM weekday worker												
Mo - Th		06:00		08:00		12:00		13:00 ¹⁾		17:00 ¹⁾		22:00 ¹⁾
Fr		06:00		08:00		12:00		13:00 ¹⁾		17:00 ¹⁾		23:30 ¹⁾
Sa		07:00		23:30 ¹⁾	-	-	-	-	-	-	-	-
Su		08:00		22:00 ¹⁾	-	-	-	-	-	-	-	-
Home all day (Default setting)												
Mo - Th		06:00		22:00 ¹⁾	-	-	-	-	-	-	-	-
Fr		06:00		23:30 ¹⁾	-	-	-	-	-	-	-	-
Sa		07:00		23:30 ¹⁾	-	-	-	-	-	-	-	-
Su		08:00		22:00 ¹⁾	-	-	-	-	-	-	-	-

































































Tab. 22

	P1		P2		P3		P4		P5		P6	
	  		  		  		  		  		  	
Home all day, early												
Mo - Th		04:00		22:00 ¹⁾	-	-	-	-	-	-	-	-
Fr		04:00		23:00 ¹⁾	-	-	-	-	-	-	-	-
Sa		07:00		23:00 ¹⁾	-	-	-	-	-	-	-	-
Su		07:00		22:00 ¹⁾	-	-	-	-	-	-	-	-
Home all day, late												
Mo - Th		06:00		23:30 ¹⁾	-	-	-	-	-	-	-	-
Fr		06:00		23:30 ¹⁾	-	-	-	-	-	-	-	-
Sa		07:00		23:30 ¹⁾	-	-	-	-	-	-	-	-
Su		08:00		23:30 ¹⁾	-	-	-	-	-	-	-	-
Senior citizens												
Mo - Th		07:00		23:00 ¹⁾	-	-	-	-	-	-	-	-
Fr		07:00		23:00 ¹⁾	-	-	-	-	-	-	-	-
Sa		07:00		23:00 ¹⁾	-	-	-	-	-	-	-	-
Su		07:00		23:00 ¹⁾	-	-	-	-	-	-	-	-

Tab. 22







1) Display subject to the selected "Display format"

Ready-made heating programmes in programme locations A to F (can be modified)

	P1		P2		P3		P4		P5		P6	
	  		  		  		  		  		  	
Programme A												
All days												
Mon - Fri												
Sat + Sun												
Monday		06:00		22:00 ¹⁾								
Tuesday		06:00		22:00 ¹⁾								
Wednesday		06:00		22:00 ¹⁾								
Thursday		06:00		22:00 ¹⁾								
Friday		06:00		23:30 ¹⁾								
Saturday		07:00		23:30 ¹⁾								
Sunday		08:00		22:00 ¹⁾								
Programme B												
All days												
Mon - Fri												
Sat + Sun												
Monday		06:00		08:00		17:00 ¹⁾		22:00 ¹⁾				
Tuesday		06:00		08:00		17:00 ¹⁾		22:00 ¹⁾				
Wednesday		06:00		08:00		17:00 ¹⁾		22:00 ¹⁾				
Thursday		06:00		08:00		17:00 ¹⁾		22:00 ¹⁾				
Friday		06:00		08:00		17:00 ¹⁾		23:30 ¹⁾				
Saturday		07:00		23:30 ¹⁾								
Sunday		08:00		22:00 ¹⁾								
Programme C												
All days		07:00		23:00 ¹⁾								
Mon - Fri												
Sat + Sun												
Monday												
Tuesday												
Wednesday												
Thursday												
Friday												
Saturday												
Sunday												

Tab. 23

1) Display subject to the selected "Display format"













	P2		P3		P4		P5		P6		P1
	°C		°C		°C		°C		°C		
Programme D											
All days											
Mon - Fri											
Sat + Sun											
Monday	21	06:00	5	22:00 ¹⁾							
Tuesday	21	06:00	5	22:00 ¹⁾							
Wednesday	21	06:00	5	22:00 ¹⁾							
Thursday	21	06:00	5	22:00 ¹⁾							
Friday	21	06:00	5	23:30 ¹⁾							
Saturday	21	07:00	5	23:30 ¹⁾							
Sunday	21	08:00	5	22:00 ¹⁾							
Programme E											
All days											
Mon - Fri											
Sat + Sun											
Monday	21	06:00	15	08:00	21	17:00 ¹⁾	5	22:00 ¹⁾			
Tuesday	21	06:00	15	08:00	21	17:00 ¹⁾	5	22:00 ¹⁾			
Wednesday	21	06:00	15	08:00	21	17:00 ¹⁾	5	22:00 ¹⁾			
Thursday	21	06:00	15	08:00	21	17:00 ¹⁾	5	22:00 ¹⁾			
Friday	21	06:00	15	08:00	21	17:00 ¹⁾	5	23:30 ¹⁾			
Saturday	21	07:00	5	23:30 ¹⁾							
Sunday	21	08:00	5	22:00 ¹⁾							
Programme F											
All days	21	07:00	15	23:00 ¹⁾							
Mon - Fri											
Sat + Sun											
Monday											
Tuesday											
Wednesday											
Thursday											
Friday											
Saturday											
Sunday											

Tab. 24







1) Display subject to the selected "Display format"

Individual timer programme settings

Own settings

	P1		P2		P3		P4		P5		P6	
												
Programme location A, name: _____												
All days												
Mon - Fri												
Sat + Sun												
Monday												
Tuesday												
Wednesday												
Thursday												
Friday												
Saturday												
Sunday												
Programme location B, name: _____												
All days												
Mon - Fri												
Sat + Sun												
Monday												
Tuesday												
Wednesday												
Thursday												
Friday												
Saturday												
Sunday												
Programme location C, name: _____												
All days												
Mon - Fri												
Sat + Sun												
Monday												
Tuesday												
Wednesday												
Thursday												
Friday												
Saturday												
Sunday												

Tab. 25

	P2		P3		P4		P5		P6		P1
	°C		°C		°C		°C		°C		
Programme location D, name: _____											
All days											
Mon - Fri											
Sat + Sun											
Monday											
Tuesday											
Wednesday											
Thursday											
Friday											
Saturday											
Sunday											
Programme location E, name: _____											
All days											
Mon - Fri											
Sat + Sun											
Monday											
Tuesday											
Wednesday											
Thursday											
Friday											
Saturday											
Sunday											
Programme location F, name: _____											
All days											
Mon - Fri											
Sat + Sun											
Monday											
Tuesday											
Wednesday											
Thursday											
Friday											
Saturday											
Sunday											

Tab. 26

13.2 DHW programme

How to set the domestic hot water programme is described in Section 6.3 on page 36.







	P1		P2		P3		P4		P5		P6	
	°C ¹⁾	⌚	°C ¹⁾	⌚	°C ¹⁾	⌚	°C ¹⁾	⌚	°C ¹⁾	⌚	°C ¹⁾	⌚
Default setting												
Mo - Th	60/ On	05:00	15/ Off	23:00 ²⁾	-	-	-	-	-	-	-	-
Fr	60/ On	05:00	15/ Off	23:00 ²⁾	-	-	-	-	-	-	-	-
Sa	60/ On	06:00	15/ Off	23:00 ²⁾	-	-	-	-	-	-	-	-
Su	60/ On	07:00	15/ Off	23:00 ²⁾	-	-	-	-	-	-	-	-
Personal setting for Domestic hot water												
All days												
Mon - Fri												
Sat + Sun												
Monday												
Tuesday												
Wednesday												
Thursday												
Friday												
Saturday												
Sunday												

Tab. 27

- 1) Temperature level only on systems with DHW cylinder; On/Off with combination boilers
- 2) Display subject to the selected "Display format"

13.3 Domestic hot water circulation programme (only on systems with DHW cylinder)

How to set the domestic hot water circulation programme is described in Section 6.3 on page 36.

	P1		P2		P3		P4		P5		P6	
	On/ Off		On/ Off		On/ Off		On/ Off		On/ Off		On/ Off	
Default setting												
Mo - Th	On	06:00	Off	23:00 ¹⁾	-	-	-	-	-	-	-	-
Fr	On	06:00	Off	23:00 ¹⁾	-	-	-	-	-	-	-	-
Sa	On	07:00	Off	23:00 ¹⁾	-	-	-	-	-	-	-	-
Su	On	08:00	Off	23:00 ¹⁾	-	-	-	-	-	-	-	-
Personal setting												
All days												
Mon - Fri												
Sat + Sun												
Monday												
Tuesday												
Wednesday												
Thursday												
Friday												
Saturday												
Sunday												

Tab. 28

1) Display subject to the selected "Display format"

Index

A

Accessories10, 13
Appliance details
- Accessories10
Automatic system configuration15, **52**

B

Basic display43
Being away from home23
Boiler
- Equipment9
- Fault59
- Settings33, 36, 53
BUS devices**52**, 59
BUS leads14
Button3

C

Changing heating programme name34
Changing operating mode23
Changing room temperature**25**, 36
Climate zone56
Colder
- Heating25
Collector area56
Commissioning (for installers only)15
Commissioning report67
Contrast43
Control quality12
Controller messages59
Controls3
Cooler
- Domestic hot water36
- Domestic hot water38, 39, 40
Customer service address50, **58**

D

Default settings 22, 27, 49, 54
Dimensions 12
Display
- Basic display 43
- Contrast 43
Display formats 43
Disposal 13, **66**
Domestic hot water circulation 40
Domestic hot water programme 30, **36**

E

Editing domestic
hot water programme 38, 39, 40
Editing heating programme 33, 34, 35
Editing programme for
domestic hot water circulation pump ... 40, 41
Electrical connections 14
- Connecting bus devices 14
Environmental protection 66

F

Factory settings **22**, 27, 49
Fault indication 59
Fault rectification 59
Faults 50, 58, **59**
- Boiler 59
Fitting
- Accessories 13
- FR 110 12
Fitting location
- Collector temperature sensor 61

G

General settings 32, **43**

- ## H
- Heating 33
 - Heating programme 28, **33**
 - Heat-up optimisation 53, 64
 - Higher
 - Heating 33, 34, 35, 36
 - Holiday programme **24**, 27
 - Hotter
 - Domestic hot water 36, 38, 39, 40
- ## I
- Individual timer programmes (table) 68
 - Info **45**, 51, 58
 - Information on the basic display 43
 - Information regarding these instructions 6
 - Installation 12
 - Accessories 13
 - FR 110 12
 - Installation site
 - FR 110 12
 - Installer settings 48
 - Configuring solar system 49, **54**
 - Customer service address 50, **58**
 - Heating parameters 49, **53**
 - Solar system parameters 50, **54**
 - System configuration 49, **52**
 - System faults 50, **58**
 - System info 51, **58**
- ## K
- Key lock 43
- ## L
- Leaving the apartment 23
 - Leaving the house 23
 - Lower
 - Heating 33, 34, 35, 36
- ## M
- Main menu
 - Domestic hot water 30, **36**
 - General settings 32, **43**
 - Heating 28, **33**
 - Holiday **24**, 27
 - Solar 32, **44**
 - Menu
 - Info 45
 - Installer level 48
 - Installer settings
 - Configuring solar system 49, **54**
 - Customer service address 50, **58**
 - Heating parameters 49, **53**
 - Solar system parameters 50, **54**
 - System configuration 49, **52**
 - System faults 50, **58**
 - System info 51, **58**
 - Main menu
 - Domestic hot water 30, **36**
 - General settings 32, **43**
 - Heating 28, **33**
 - Holiday **24**, 27
 - Solar 32, **44**
 - Menu structure 27, 45, 49
- ## N
- Night-time operation (economy) 36
- ## O
- Operation 16
 - Changing hot water mode 24
 - Changing room temperature 25, **36**
 - Changing the operating mode for heating 23
 - Setting heating temperature 36
 - Option E: Thermal disinfection of the solar cylinder **54**

P

Packaging13, **66**
Product details
- Standard package9
Programming
- Installer settings48
- Resetting to default settings
- All settings22
- Domestic hot water programme ..38, 39
- Heating programme34
- Setting domestic
hot water programme36, 38, 39, 40
- Setting heating programme**33**, 34, 35
- Setting holiday programme24
- Setting language43
- Setting programme for domestic
hot water circulation pump40, 41
- Setting summer/winter time43
- Setting the date43
- Setting the time43

R

Recycling66
Reserve power supply
- Mains power failure9
Reset
- All settings22
- Domestic hot water programme ..38, 39
- Heating programme34
Resetting
- All settings22
- Domestic hot water programme ..38, 39
- Heating programme34
Resetting settings22, 34, 38, 39
Room temperature sensor53
Rotary selector3

S

Safety precautions8
Segment3
Setting constant economy23
Setting constant frost protection23
Setting constant heating23
Setting domestic
hot water hotter/cooler38, 39, 40
Setting economy mode23
Setting frost protection mode23
Setting heating higher/lower**33**, 34, 35
Setting heating mode23
Setting heating start time**33**
Setting heating temperature36
Setting language43
Setting summer/winter time43
Setting the date43
Setting the time43
Setting up automatic mode23
Solar module for heating
boost ISM 1 (optional accessory)11
Solar optimisation44
Solar programme32, **44**
Solar pump
- SP**55**
Standard package9
Standard solar system**55**
Symbols3
System configuration52
- Automatic15, **52**
System faults50, **58**
System information45, 58

T

Technical data	10
Thermal disinfection	25, 42
Thermostatic valves	64
Time adjustment	43
Timer programmes	17, 33 , 68
Times for domestic hot water	36
Troubleshooting	59

U

Used appliances	66
-----------------------	----

V

Venting	64
---------------	----

W

Wall-mounting	12
Warmer	
- Heating	25



067206177622

CONTACT INFORMATION

WORCESTER, BOSCH GROUP:

TECHNICAL: 08705 266241
SERVICE: 08457 256206
SPARES: 01905 752571
LITERATURE: 01905 752556
TRAINING: 01905 752526
SALES: 01905 752640
WEBSITE: www.worcester-bosch.co.uk

Dedicated to heating comfort

Worcester, Bosch Group
Cotswold Way, Warndon, Worcester WR4 9SW
Tel. 01905 754624 Fax. 01905 754619
Worcester, Bosch Group is a brand name of
Bosch Thermotechnology Ltd.
www.worcester-bosch.co.uk

