

DT10RF PROGRAMMER

DT10RF OPTIMISING PROGRAMMER

DIGISTAT - Radio frequency controlled programmable room thermostat with domestic hot water programmer

FOR GREENSTAR i and GREENSTAR Si MODELS

OPTIMISING DIGISTAT - Radio frequency controlled programmable optimising room thermostat with domestic hot water programmer

FOR GREENSTAR Si MODELS

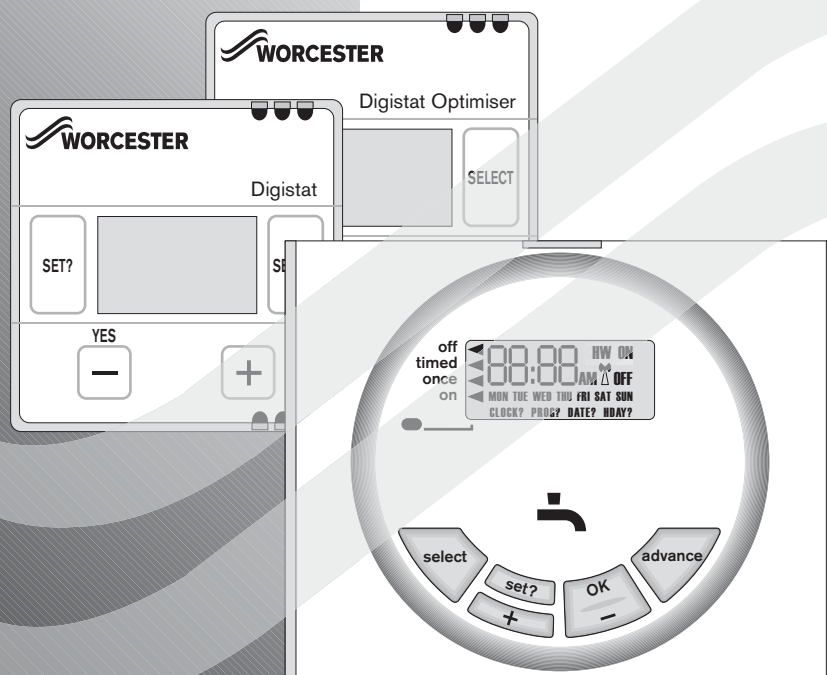

 **WORCESTER**
Bosch Group

INSTRUCTION MANUAL
FITTING & OPERATING INSTRUCTIONS

CONTACT INFORMATION

WORCESTER BOSCH:

TECHNICAL: 08705 266241
SERVICE: 08547 256206
SPARES: 01905 752571
LITERATURE: 01905 752556
TRAINING: 01905 752526
SALES: 01905 752640
WEBSITE: www.worcester-bosch.co.uk

MANUAL INFORMATION

PLEASE READ THESE INSTRUCTIONS CAREFULLY BEFORE STARTING

THESE INSTRUCTIONS ARE APPLICABLE TO THE WORCESTER BOSCH MODEL(S) STATED ON THE FRONT COVER OF THIS MANUAL ONLY AND MUST NOT BE USED WITH ANY OTHER MAKE OR MODEL

THE INSTRUCTIONS APPLY IN THE UK ONLY AND SHOULD BE FOLLOWED EXCEPT FOR ANY STATUTORY OBLIGATION

IF YOU ARE IN ANY DOUBT CONTACT WORCESTER BOSCH TECHNICAL HELPLINE

THIS ACCESSORY MUST BE FITTED BY A COMPETENT PERSON. FAILURE TO COMPLY COULD LEAD TO PROSECUTION.

LEAVE THESE INSTRUCTIONS WITH THE USER OR AT THE APPLIANCE.

ABBREVIATIONS:

CH Central Heating

HW Domestic Hot Water

RF Radio Frequency

DLS Day Light Saving

BST British Summer Time

GMT Greenwich Mean Time

C Celcius

m Metre

IP Ingress Protection

V Volts

mA MilliAmps

DEFINITIONS (DLS/BST):

Summer period begin: Last Sunday in March at 1:00 AM GMT (Clock put forward by 60 minutes)

Summer period end: Last Sunday in October at 2:00 AM GMT (Clock put back by 60 minutes)

SYMBOLS:

 Central Heating

 Domestic Hot Water

 Radio Frequency (RF) transmitter

CONTENTS

ACCESSORY INFORMATION

| | |
|---------------------|---|
| GENERAL INFORMATION | 2 |
| TECHNICAL DATA | 3 |

INSTALLATION & COMMISSIONING:

| | |
|--|---|
| FITTING THE RECEIVER | 4 |
| SETTING UP THE RADIO LINK | 5 |
| TRANSMITTER LOCATION, CLEARANCE & FIXING | 6 |

USER INSTRUCTIONS:

| | |
|---------------------------------|--------|
| TRANSMITTER OPERATING CONTROLS | 7 |
| TRANSMITTER PRE-SET PROGRAMS | 8 |
| TRANSMITTER SETTINGS | |
| Setting the clock | 9 |
| Setting times and temperatures | 10, 11 |
| RECEIVER OPERATING CONTROLS | 12 |
| RECEIVER PRE-SET PROGRAMS | 13 |
| RECEIVER SETTING PROGRAMS | |
| Setting MON - FRI | 14 |
| Setting individual weekdays | 15 |
| Setting SAT & SUN | 16 |
| Setting individual weekend days | 17 |
| RECEIVER SETTING HOLIDAYS | 18 |
| RECEIVER SETTING THE CLOCK | 19 |
| RECEIVER SETTING THE DATE | 20 |
| BATTERY REPLACEMENT | 21 |

SERVICING & SPARES:

| | |
|----------------------|----|
| MAINTENANCE & SPARES | 22 |
|----------------------|----|

CONTENTS

ACCESSORY
INFORMATION

INSTALLATION &
COMMISSIONING

USER
INSTRUCTIONS

SERVICING
& SPARES

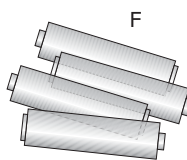
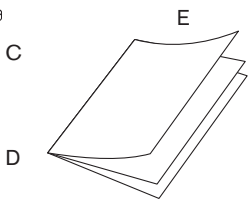
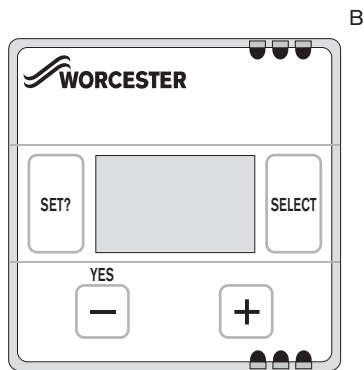
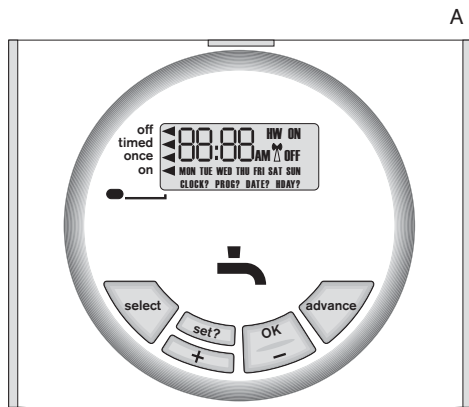

GENERAL INFORMATION

STANDARD PACKAGE:

- A - DT10 Programmer/ RF receiver
- B - Remote RF transmitter
- C - Screws (x2)
- D - Wall Plugs (x2)
- E - Instructions
- F - Batteries (x4)

SPECIFICATIONS:

Receiver:

- Programmer/receiver for DHW mounted into the boiler fascia
- 7 day programmer
- 3 on/off periods per day
- Automatic BST settings
- Pre-programmed on/off periods
- Dedicated advance buttons
- 12 or 24 hour back-lit digital display
- Holiday function
- Pre-wired with PCB connector

Digistat transmitter:

Radio frequency controlled programmable room thermostat with domestic hot water programmer

- Remote 24 hour programmable RF Transmitter to control CH temperature
- AA alkaline LR6 batteries included
- Low battery warning
- Max. signal range approx. 25 metres (range may decrease according to the building construction).

Digistat Optimising transmitter:

Radio frequency controlled programmable optimising room thermostat with domestic hot water programmer

- Same as Digistat above, plus:
- Remote 7 day programmable RF Transmitter to control CH temperature
- Optimum start.

TECHNICAL DATA

| DESCRIPTION | UNITS | DT10RF Receiver |
|-------------------------------|----------------------------|-----------------|
| Dimensions | mm | - |
| Electrical supply | - | 24v DC <65mA |
| Ambient operating temperature | °C | 0 to +50 |
| Humidity operating range | % non-condensing up to 45° | 30 - 95 |
| Class of protection | - | II |
| Degree of protection | IP | 24 |
| Accuracy @25°C | sec/day | <±1 |
| Battery life | years | 10 |
| Battery backup time & date | years min. | 10 |
| Shortest switching period | minutes | 1 |
| On/Off periods | number | 3 |
| Programs | days | 7 |

ACCESSORY
INFORMATION

Related Standards:

BS EN60730-1:2001

BS EN60730-2-7:1992

Electro Magnetic Compatibility and Radio Spectrum Matters (ERM); Short Range Devices (SRD) ETSI
EN 300 220-1

EC Directives:

European Union Law Directive 2000/84/EC

Low Voltage Directive (73/23/EEC)

Electro Magnetic Compatibility Directive (89/336/EEC)

CE Marking Directive (93/68/EEC)

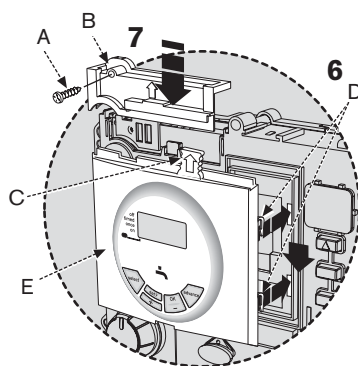
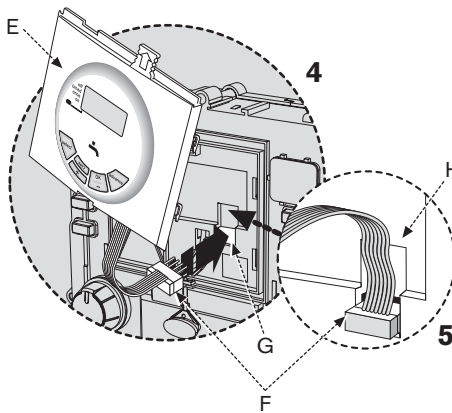
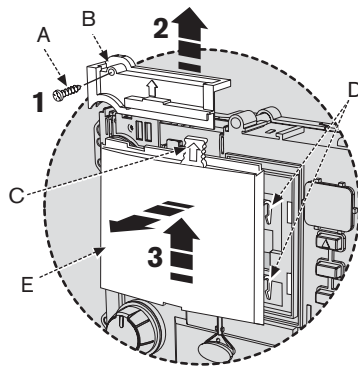

FITTING THE RECEIVER

DANGER - 24V & 230V: DO NOT TOUCH THE ELECTRICAL COMPONENTS OR CIRCUITS.

CAUTION: ISOLATE THE MAINS ELECTRICITY SUPPLY BEFORE STARTING ANY WORK AND OBSERVE ALL RELEVANT SAFETY PRECAUTIONS.

OBSERVE ELECTRONIC STATIC DISCHARGE PRECAUTIONS. DO NOT TOUCH THE PCB CIRCUITS

- ▶ **Important: Switch off boiler**
- ▶ Remove boiler outer casing and control panel fascia to gain access to the heatronic control panel
- 1 Release securing screw (A)
- 2 Pull cover panel (B) upwards to remove
- 3 Grip tab (C), pull upwards to disengage clips (D) and pull forwards to remove blanking plate (E) or existing programmer
- 4 Align connector pins (F) into receptors (G) in the pcb and push fully home
- 5 Feed the ribbon cable (G) into recess (H)
- 6 Align programmer (E) and locate clips (D), push into slots then downwards to secure using grip tab (C)
- 7 Locate cover panel (B) and secure with screw (A)
- ▶ Replace fascia cover and outer casing before switching on the electricity supply and boiler
- ▶ Switch boiler on when completed.
- ▶ Refer to 'USERS INSTRUCTIONS' section for details of pre-set and setting programs.

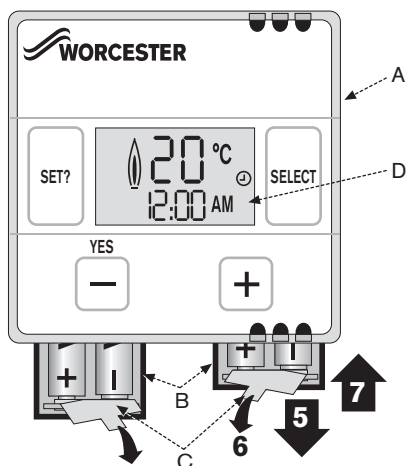
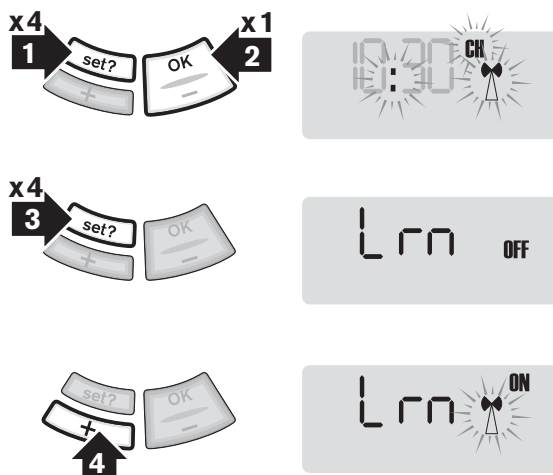

SETTING UP THE RADIO LINK

Receiver set up:

► The colon, CH and antenna symbols should flash on the display

- 1 Press the 'set?' button 4 times
- 2 Press the 'OK' button once
- 3 Press the 'set?' button 4 times; 'Lrn' and 'OFF' should be displayed
- 4 Press the '+' button so the display shows 'ON' and a flashing antenna symbol. The learn mode is now ready to receive a signal from the transmitter during the next 2 minutes.

Transmitter set up:

The transmitter must be at least 1 metre away from the receiver before starting this procedure:

- 5 Slide open battery compartments (B)
- 6 Remove insulator strips (C)
- 7 Replace the **right hand** battery compartment (B) **first** followed by the left hand battery compartment

The display (D) then shows the room temperature and automatically transmits a signal to the receiver unit in the boiler to establish a radio link.

- 8 When a radio link has been established the display reverts back to normal operation with the antenna symbol shown

To re-establish the radio link; open both battery trays until the transmitter display goes blank, repeat steps 1 to 4 then step 7 to transmit a set up signal to the receiver. Repeat this procedure until a link has been established.

If the radio link is lost the antenna, colon and CH symbols flash on the receiver display. The program defaults to manual mode. Press the 'OK' button to override and switch the heating ON, press again to switch OFF.

INSTALLATION & COMMISSIONING

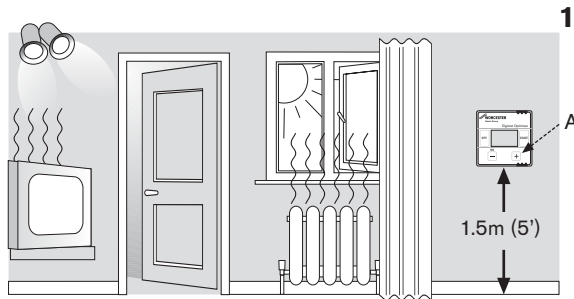

TRANSMITTER LOCATION CLEARANCES & FIXING

Transmitter location:

- 1 Position the transmitter (A) as close to the main living area as possible onto a flat inside wall, approx. 1.5m (5') above the floor within max. signal range of the appliance receiver.

Keep the transmitter away from:

- light and heat sources
- enclosures and curtains
- direct draughts, including fans, air vents, windows and doors
- damp and condensation

Replacing a mains wired unit:

Isolate the main electric supply. Refer to the manufacturers instructions to remove the unit. Isolate the existing wiring and make electrically safe.

Transmitter clearances:

See diagram opposite for minimum area required for operation.

Transmitter fixing:

SAFETY: All relevant safety precautions must be undertaken. Protective clothing, footwear, gloves and safety goggles must be worn as appropriate.

CAUTION: Ensure there are no pipes, electric cables or other hazards before drilling.

- 2 Loosen screw (C) on transmitter to remove the baseplate (B)
- 3 Hold baseplate (B) level to mark securing points (D) and remove baseplate (B)
- 4 ▶ Drill holes to marks
 - ▶ Fit one wall plug into each hole
 - ▶ Reposition baseplate (B), check level and secure with screws supplied
 - ▶ Refit the transmitter to the baseplate (B) and tighten screw (C) to secure.

INSTALLATION & COMMISSIONING

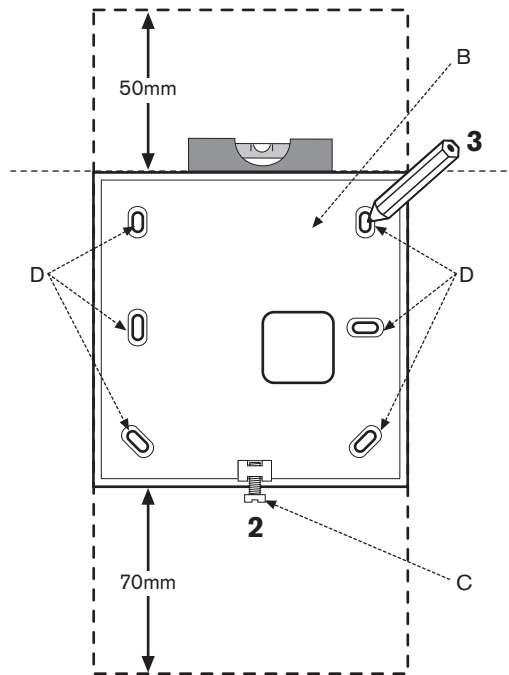

6

TRANSMITTER LOCATION CLEARANCES & FIXING

FITTING & OPERATING INSTRUCTIONS FOR WORCESTER BOSCH
DT10RF PROGRAMMER & DT10RF OPTIMISING PROGRAMMER
8-716-106-652 issue c. (01.05) UK

WORCESTER
Bosch Group

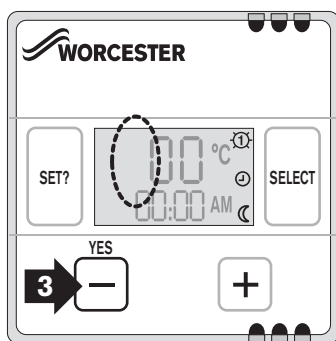
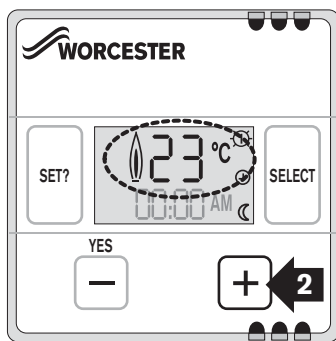
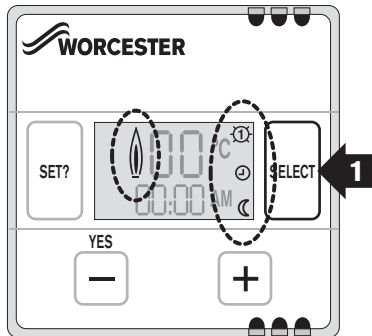

TRANSMITTER OPERATING CONTROLS

To select a pre-set CH program:

1 Press the 'SELECT' button to change to the program to suit your requirements as follows:

- ⌚ Normal running (all pre-set times and temperatures)
- ⌚ Continuous '1' first temperature
- 🌙 Continuous 'night' temperature

The flame symbol indicates:

- 🔥 Flame on = heating demand ON
- Flame off = heating demand OFF
- 🔥 (flashing) Flame flashing = energy saving for Optimiser only

To change the room temperature:

Note: the following only occurs during a timed on period and has no effect when the receiver is in an off setting.

- 2 To increase the room temperature: press the '+' button until the required temperature is displayed
- 3 To decrease the room temperature: press the '-' button until the flame symbol is no longer displayed

After 5 seconds the display reverts back to the actual room temperature.

Optimum start (Digistat Optimiser only):

This unit features an energy saving system which, during milder weather, automatically delays the first start up of the day from 0 to 60 minutes depending on:

- actual room temperature at the first switch on time only
 - set temperature at the first switch on
 - how fast the heating system responded on the previous day
- ▶ Press the '+' button once only to override a delayed start.

USER
INSTRUCTIONS

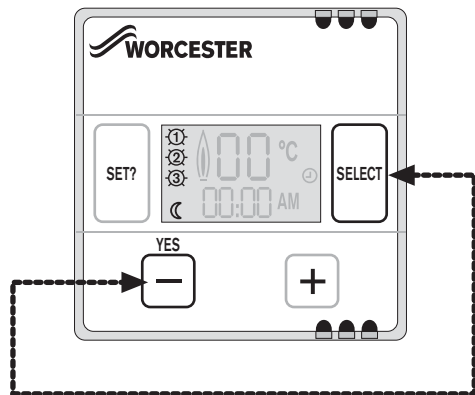

**DIGISTAT
(24 HOUR) PRE-SET PROGRAM**

| | ① | ② | ③ | ☾ |
|-------------------------|------|------|-------|-------|
| Central Heating: | | | | |
| <i>24 Hours:</i> | | | | |
| Start time | 6:30 | 8:30 | 16:30 | 22:30 |
| Temperature °C | 20 | 16 | 21 | 7 |

**DIGISTAT OPTIMISER
(7 DAY) PRE-SET PROGRAM**

| | ① | ② | ③ | ☾ |
|-------------------------|------|------|-------|-------|
| Central Heating: | | | | |
| <i>MON to FRI:</i> | | | | |
| Start time | 6:30 | 8:30 | 16:30 | 22:30 |
| Temperature °C | 20 | 16 | 21 | 7 |
| <i>SAT & SUN:</i> | | | | |
| Start time | 7:00 | 9:00 | 16:00 | 23:00 |
| Temperature °C | 20 | 16 | 21 | 7 |

**TRANSMITTER
PRE-SET PROGRAMS**

Transmitter:

The default pre-set daily start times and temperatures are shown in the table opposite for the Digistat (24 hour) and the Digistat Optimiser (7 day) remote transmitters

Press the 'select' and '-' buttons together and hold for 2 seconds to reset the default program times

See 'TRANSMITTER SETTING PROGRAMS' in the USER INSTRUCTIONS section if changes are required to the clock time or pre-programmed settings.

TRANSMITTER SETTINGS

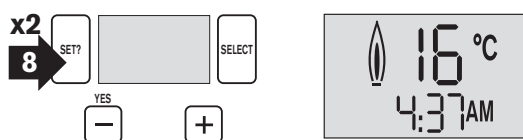
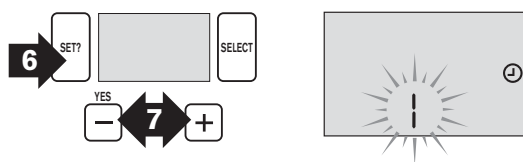
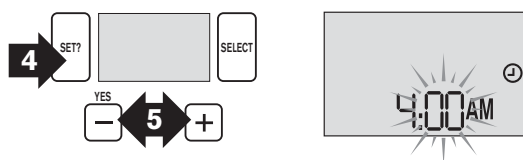
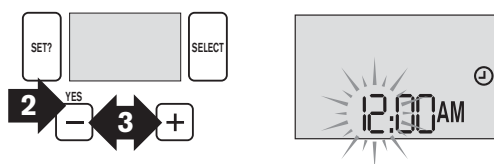
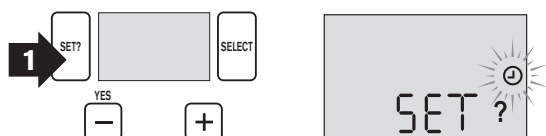

Setting the clock:

- 1 Press 'SET?' button once and 'SET?' and the clock symbol are displayed
- 2 Press 'YES (-)' and the hours flash
- 3 Press '-' & '+' to set correct hour
- 4 Press 'SET?' and the minutes flash
- 5 Press '-' & '+' to change minutes
- ▶ Press 'SET?' twice to return to normal running mode

Digistat Optimiser only:

- 6 Press 'SET?' a day of the week flashes (1 = Monday, 7 = Sunday)
- 7 Press '-' & '+' to choose day
- 8 Press 'SET?' twice to return to normal operation

USER
INSTRUCTIONS

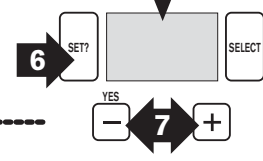
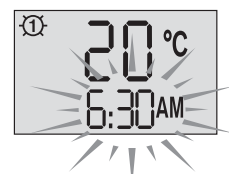
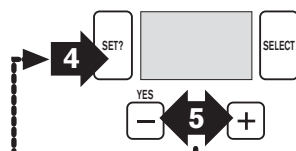
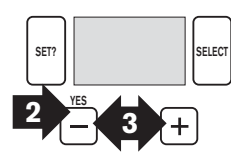
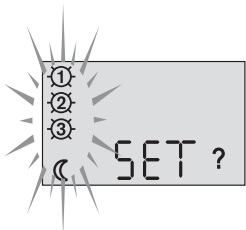
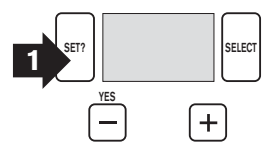

TRANSMITTER SETTINGS

DIGISTAT Only:

Setting times and temperatures:

- 1 Press 'SET?' until the display flashes as shown opposite
 - 2 Press 'YES (-)' the temperature flashes for the 1st ON period
 - 3 Press '-' & '+' to change the temperature for the 1st ON period
 - 4 Press 'SET?' the start time flashes
 - 5 Press '-' & '+' to change the start time
 - 6 Press 'SET?' the temperature flashes for the next start period
 - 7 Press '-' & '+' to change the temperature for the next ON period
- ▶ Repeat steps 4 to 7 for the 3rd period, then the night ON periods:
 - ▶ Press 'SET?' to return to normal display

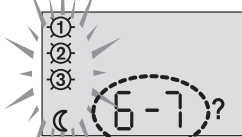
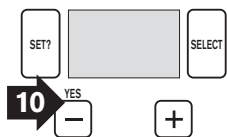
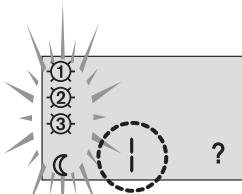
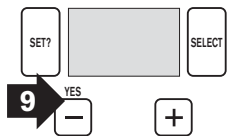
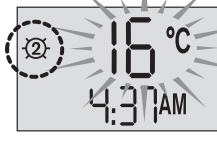
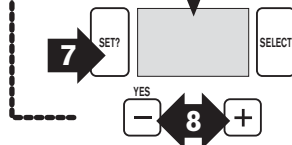
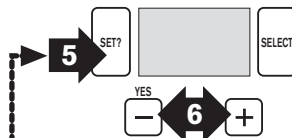
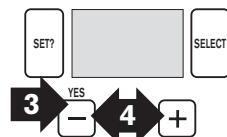
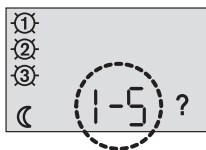
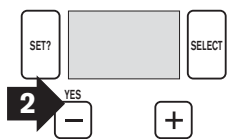
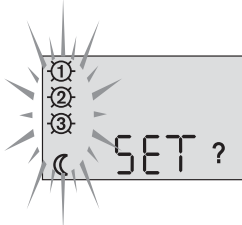
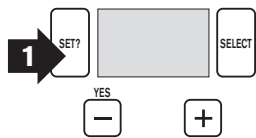

TRANSMITTER SETTINGS

DIGISTAT OPTIMISER Only:

Setting times and temperatures:

- 1 Press 'SET?' until the display flashes as shown opposite
- 2 Press 'YES (-)' and '1-5' is displayed (Monday to Friday)
- 3 Press 'YES (-)' the temperature flashes for the 1st ON period
- 4 Press '-' & '+' to change the temperature for the 1st ON period
- 5 Press 'SET?' the start time flashes
- 6 Press '-' & '+' to change the start time
- 7 Press 'SET?' the temperature flashes for the next start period
- 8 Press '-' & '+' to change the temperature for the next ON period
- ▶ Repeat steps 5 to 8 for the 3rd period, then the night ON periods:
- ▶ Complete the 1-5 (Mon-Fri) settings until the option to change each day is displayed
- 9 To change the individual day settings press 'YES (-)' and repeat steps 5 to 8 or press 'SET?' until 6-7 (Sat-Sun) is displayed
- 10 Press 'YES (-)' and repeat steps 5 to 8 to complete the 6-7 (Sat-Sun) settings

USER INSTRUCTIONS

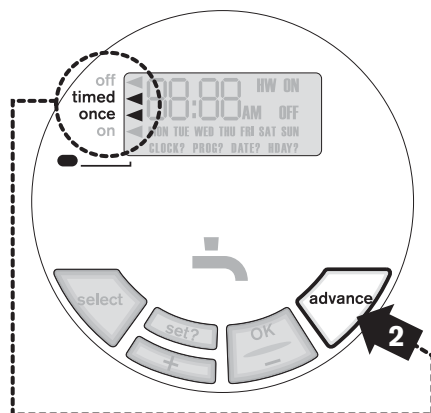
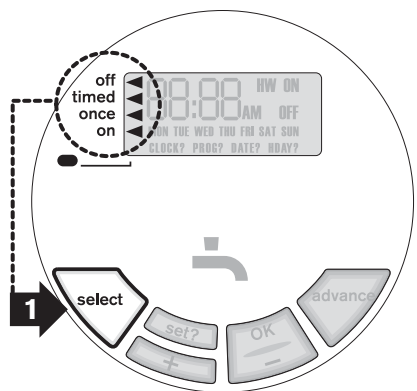

RECEIVER OPERATING CONTROLS

Hot Water:

1 Press '**select**' button to choose:

- ▶ **off** = constantly OFF
- ▶ **timed** = up to 3 ON and 3 OFF time periods as program
- ▶ **once** = ON from 1st ON until 3rd OFF time period as program
- ▶ **on** = constantly ON

2 Press '**advance**' button:

ON = hot water light on (hot water stays on until the next OFF time period)

OFF = hot water light off (hot water stays off until the next ON time period)

Note: 'advance' has no effect with the constant on or off selected on the receiver or when there is no demand from the transmitter.

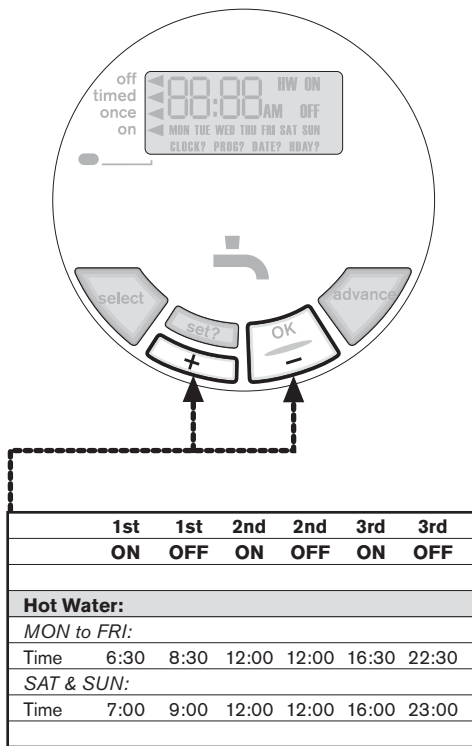

RECEIVER PRE-SET PROGRAMS

Note: The clock time is pre-programmed and should not require adjustment.

if you need to restore the factory pre-set program times then:

Press the '-' and '+' buttons together to restore the default program times to those shown in the table opposite.

The default ON/OFF periods pre-programmed for DHW are shown in the table opposite.

Note: two ON/OFF periods can be used instead of 3 by setting the 2nd ON & OFF periods to 12.00 as shown in the default program table.

One ON/OFF period can be achieved by setting the 2nd and 3rd ON & OFF periods to the same time.

See 'RECEIVER SETTING PROGRAMS' in the USER INSTRUCTIONS section if changes are required to the clock time or pre-programmed settings.

USER
INSTRUCTIONS

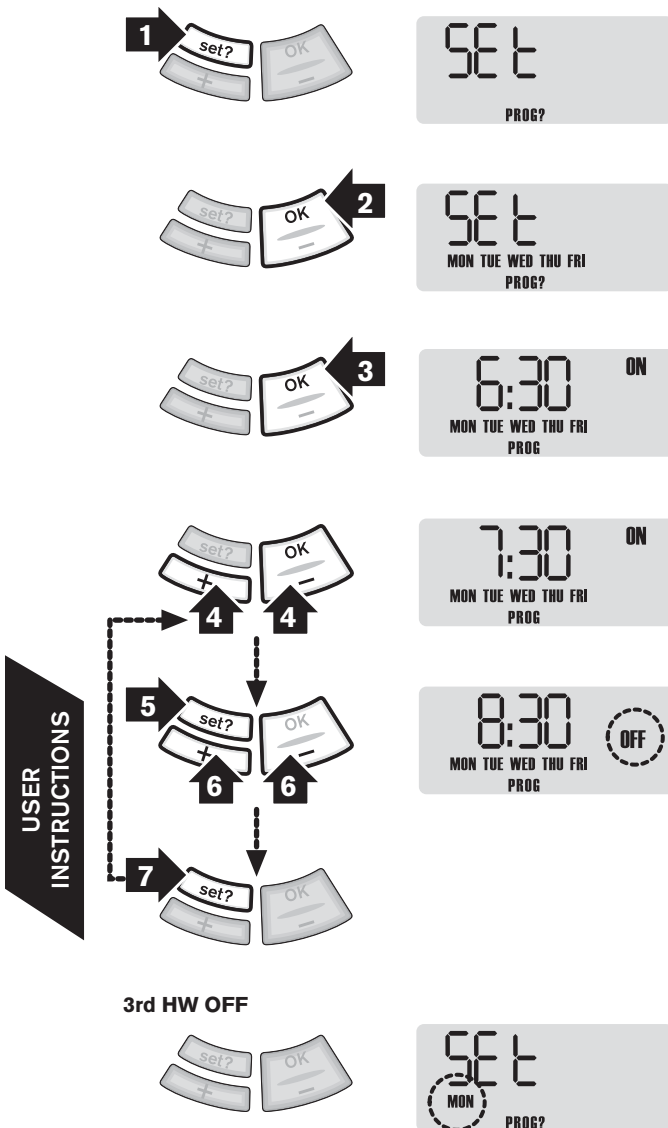

RECEIVER SETTING PROGRAMS

Setting MON - FRI:

- 1 Press 'set?' until 'SET' & 'PROG?' are shown in the display
- 2 Press 'OK' to select MON-FRI
- 3 Press 'OK' to select ON time
Note: speed up the display by holding down the '+' or '-' buttons.
- 4 Press '+' or '-' to change the ON time
- 5 Press 'set?' to set the ON time and select the OFF time
- 6 Press '+' or '-' to change the OFF time
- 7 Press 'set?' to set the OFF time and select the next ON time

Repeat operations 4 to 7 to set the 2nd and 3rd ON/OFF times.

Note: after pressing 'set?' for the 3rd HW OFF time the display shows 'SET MON . . . see next page

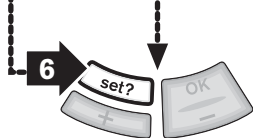
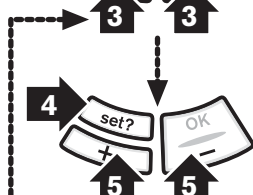

3rd HW OFF



RECEIVER SETTING PROGRAMS

Setting individual weekdays:

Note: if you do not require individual weekday times, then press 'set?' until 'SET' SAT-SUN are displayed and continue on the next page.

- ▶ If you do not wish to change the settings for the day displayed, then press 'set?' until the first day you want to change is displayed

1 Press 'OK' to select weekday

2 Press 'OK' to select 1st ON time

Note: speed up the display by holding down the '+' or '-' buttons.

3 Press '+' or '-' to change the ON time

4 Press 'set?' to set the ON time and select the OFF time

5 Press '+' or '-' to change the OFF time

6 Press 'set?' to set the OFF time and select the next ON time

Repeat operations 3 to 6 to set the 2nd and 3rd ON/OFF times.

Note: after pressing 'set?' for the 3rd OFF time 'SET' and the next weekday are displayed shown . . . after completing the steps above for FRI the display shows 'SET' SAT SUN (see next page)

USER
INSTRUCTIONS

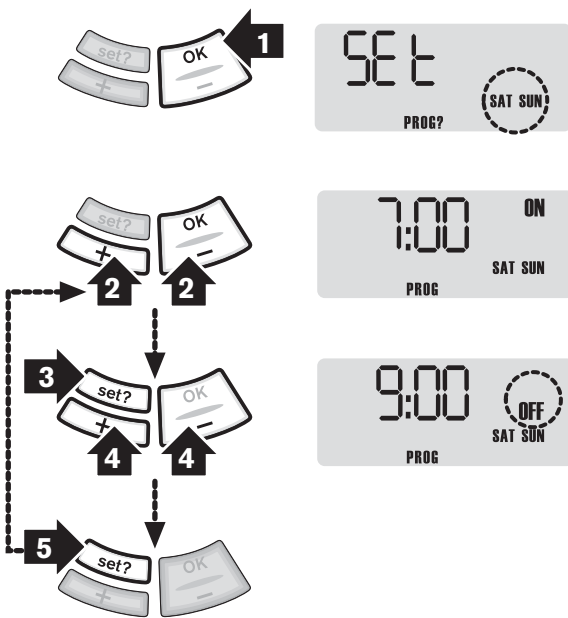

RECEIVER SETTING PROGRAMS

Setting SAT - SUN:

1 Press 'OK' to select weekend

Note: speed up the display by holding down the '+' or '-' buttons.

2 Press '+' or '-' to change the ON time

3 Press 'set?' to set the ON time and select the OFF time

4 Press '+' or '-' to change the OFF time

5 Press 'set?' to set the OFF time and select the next ON time

Repeat operations 2 to 5 to set the 2nd and 3rd ON/OFF times.

Note: after pressing 'set?' for the 3rd OFF time the display shows 'SET' SAT, see next page.

If you do not require individual weekend times, then press 'SET?' until the normal display is resumed.

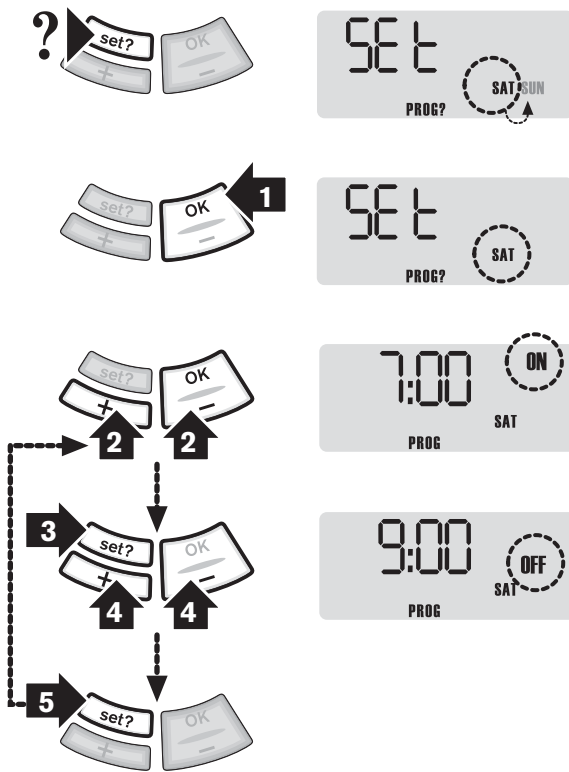

RECEIVER SETTING PROGRAMS

Setting individual weekend days:

Note: if you do not require individual weekend times, then press 'set?' until normal display is shown.

- ▶ If you do not wish to change the settings for 'SAT', then press 'set?' to move to 'SUN'

- 1 Press 'OK' to select the day displayed

Note: speed up the display by holding down the '+' or '-' buttons.

- 2 Press '+' or '-' to change the ON time
- 3 Press 'set?' to set the ON time and select the OFF time
- 4 Press '+' or '-' to change the OFF time
- 5 Press 'set?' to set the OFF time and select the next ON time

Repeat operations 2 to 5 to set the 2nd and 3rd ON/OFF times.

- ▶ Press 'set?' to change 'SUN' or until the display returns to normal mode.

USER
INSTRUCTIONS

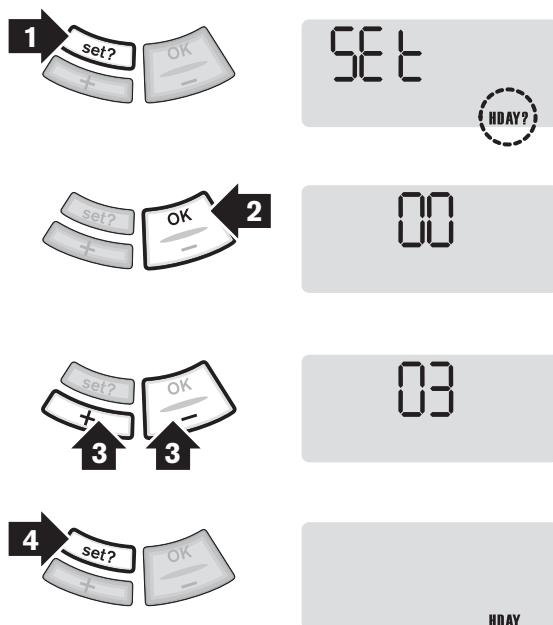

RECEIVER

SETTING HOLIDAYS

- 1 Press the 'set?' button until 'SET' & 'HDAY?' is displayed
- 2 Press 'OK' the display shows 00
- 3 Press '+' & '-' to set the number of days you require the system to be off
- 4 Press 'set?' then 'HDAY' is shown in the display and no demand for heating will be made from the programmer.

The program will return to normal after the set number of days.

- ▶ To cancel the holiday setting and return to normal operation, press any button.

Note: the programmer counts each pass through midnight as a day.

For example, if you don't want the heating on from Saturday morning until Tuesday morning, set for 3 days.

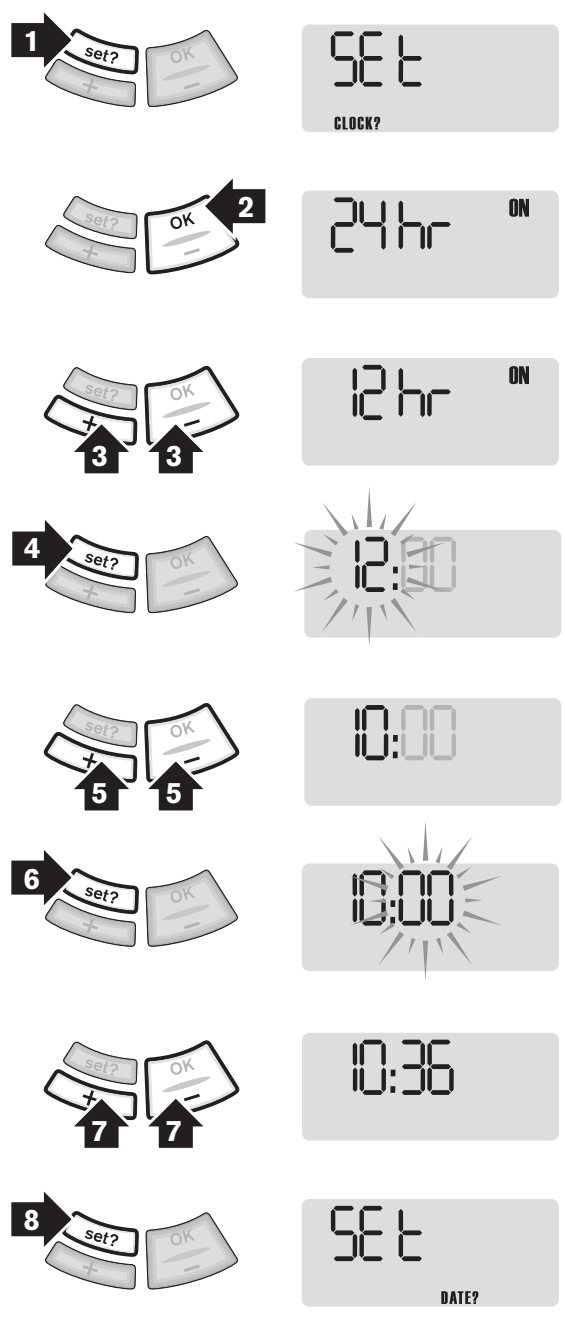

RECEIVER
SETTING THE CLOCK

- 1 Press the 'set?' button until 'SET' & 'CLOCK?' are shown in the display
- 2 Press 'OK' displays '24hr' & 'ON'
- 3 Press '+' to toggle between 24hr and 12hr display
- 4 Press 'set?' to set the clock and the hours flash on the display
- 5 Press '+' or '-' to correct hour
- 6 Press the 'set?' button to set the correct hour and the minutes flash
- 7 Press '+' or '-' to correct minutes
- 8 Press the 'set?' button to set the correct minutes. 'SET' & 'DATE?' appears in the display.

Note: speed up the display by holding down the '+' or '-' buttons.

Note: if the day displayed is incorrect the date needs resetting. To change the date see 'SETTING THE DATE'.

If you do not wish to change the date, press 'set?' to return to normal display.

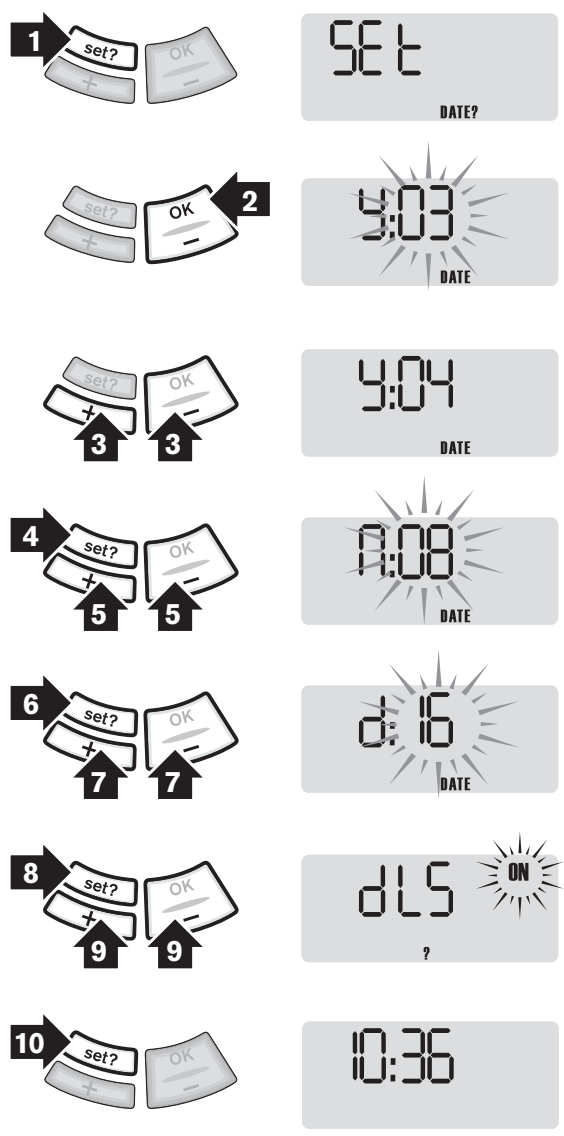

RECEIVER

SETTING THE DATE

Note: if the day displayed is incorrect the date needs resetting as follows:

- 1 Press the 'set?' button until 'SET' & 'DATE?' are shown in the display
- 2 Press the 'OK' button once, the year flashes on the display
- 3 Press '+' or '-' to correct year
- 4 Press the 'set?' button and the month flashes on the display
- 5 Press '+' or '-' to correct month
- 6 Press the 'set?' button and the day flashes on the display
- 7 Press '+' or '-' to correct day
- 8 Press the 'set?' button to set the DLS and 'ON' flashes
- 9 Press '+' or '-' for 'ON' or 'OFF'
- 10 Press 'set?' twice to return to normal display.

BATTERY REPLACEMENT

Battery symbol:

A flashing battery symbol shown in the display of transmitter (A) indicates that the batteries need replacing within 30 days.

Note: Once the batteries are removed you have 1 minute to replace the batteries before your program settings are lost.

Replacing the batteries:

Do not use rechargeable batteries

- 1 Slide open battery compartments (B)
- 2 ▶ Remove existing batteries (C) and dispose of safely
 - ▶ Replace batteries with the same type and check they are correctly fitted into the battery compartments (C)
- 3 Replace the **right hand** battery compartment (B) **first** followed by the left hand battery compartment.

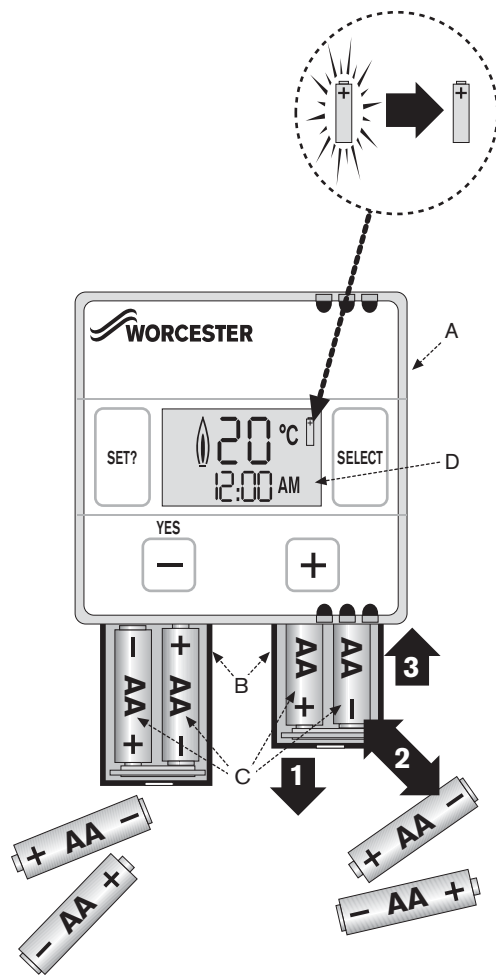

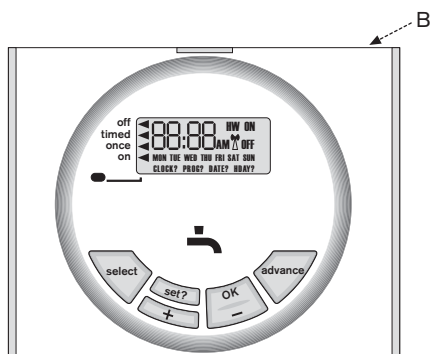
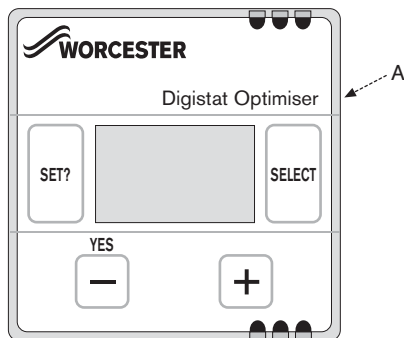

MAINTENANCE & SPARES

Maintenance:

- ▶ The transmitter (A) and receiver (B) require no maintenance
- ▶ The outer casing can be wiped clean using a dry cloth, do not use polish or detergents

Servicing:

- ▶ These units cannot be serviced.
- ▶ Should the existing unit fail to function correctly, check:
 - ▶ receiver times and program settings are correct
 - ▶ the RF signal link is setup
 - ▶ transmitter batteries are the correct type and are correctly fitted.

Replacement Parts:

- ▶ Digistat Optimiser (7 day) transmitter
part number: 8-716-106-668-0
- ▶ Receiver (DT10RF)
part number: 8-716-106-667-0
- ▶ Digistat Transmitter CH
part number: 8-716-106-666-0

