

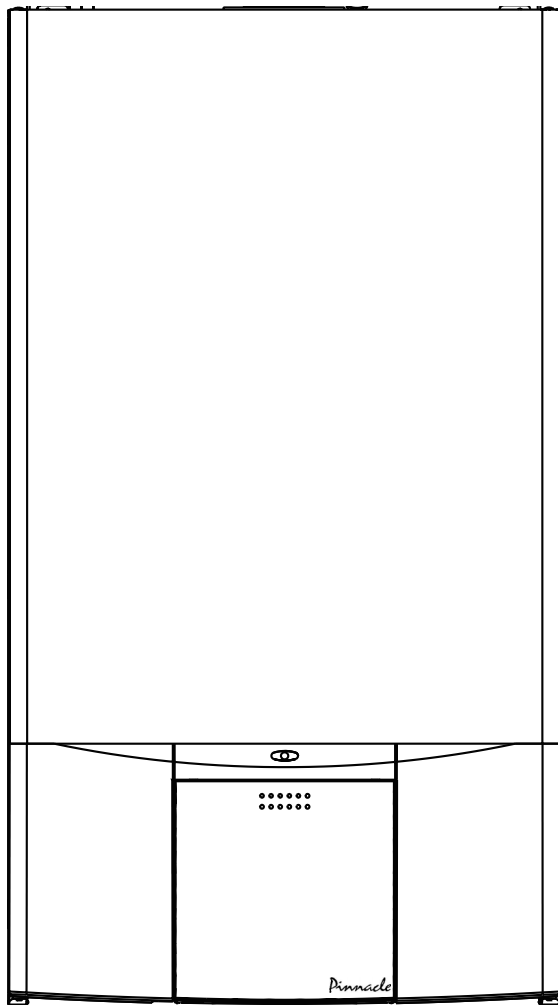

# Pinnacle



## Users Instructions

CE

**THESE INSTRUCTIONS  
TO BE RETAINED  
BY USER**



The code of practice for the installation,  
commissioning & servicing of central heating systems

# Contents

Introduction		Page
Dear customer		2
Do's and don't's		2

Things you should know		Page
1.1	Gas appliances	3
1.2	Electrical supply	3
1.3	Guarantee registration card	3
1.4	Benchmark log book	3
1.5	How does it work?	3
1.6	Dimensions	3
1.7	Clearances required	3
1.8	Frost protection system	3

Getting started		Page
2.1	Before switching on	3
2.2	Appliance controls	3
2.3	Lighting the boiler	4
2.4	Adjusting the operating temperature	4
2.5	Digital display	4
2.6	Fault code table	5

How to...		Page
3.1	Top-up the system pressure	6
3.2	Reset the appliance	6
3.3	Shut down the system for short periods	6
3.4	Shut down the system for long periods	6
3.5	Care for the appliance	6

What if...		Page
4.1	I suspect a gas leak	6
4.2	I frequently have to top-up the system	6
4.3	The status led is red	6
4.4	The appliance is due its annual service	6
4.5	I need to call an engineer	6

Setting the Vokera		Page
5.1	Mechanical clock	7
5.2	Digital clock	7

## INTRODUCTION

### Dear Customer

Your Vokera Pinnacle boiler has been designed to meet and exceed the very latest standards in gas central heating technology, and if cared for, will give years of reliable use and efficiency. Please therefore take some time to read these instructions carefully.

### Do's and don't's

- Do ensure that the system pressure is periodically checked
- Do ensure that you know how to isolate the appliance in an emergency
- Do ensure that you are familiar with the appliance controls
- Do ensure that your installer has completed the appliance log book
- Do not attempt to remove the appliance casing or gain internal access
- Do not hang clothes etc. over the appliance
- Do not forget to have the appliance serviced annually.

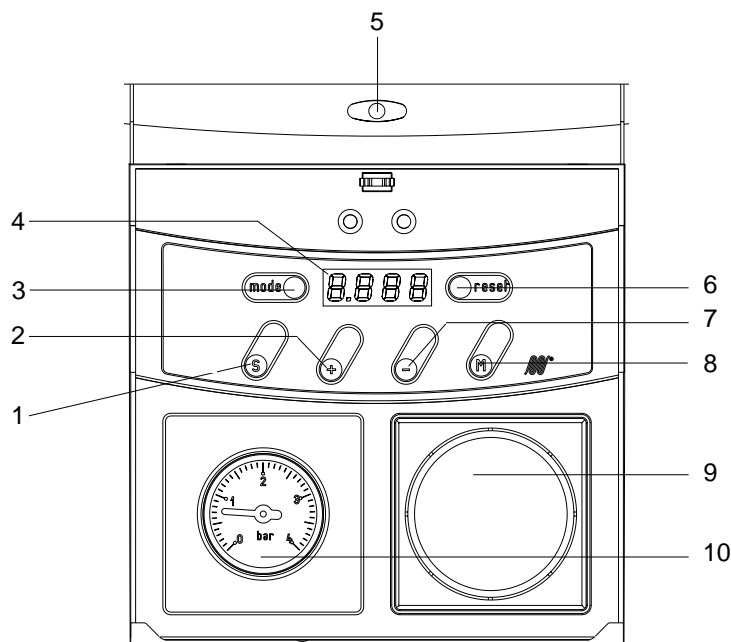

- |    |                 |     |                  |
|----|-----------------|-----|------------------|
| 1= | step button     | 6=  | reset button     |
| 2= | increase button | 7=  | decrease button  |
| 3= | mode button     | 8=  | heating selector |
| 4= | digital display | 9=  | clock aperture   |
| 5= | status LED      | 10= | pressure gauge   |

Fig. 1

---

## THINGS YOU SHOULD KNOW

---

### 1.1 GAS APPLIANCE

#### **Gas Safety (Installations and Use) Regulations.**

In the interests of your safety and that of others it is a legal requirement that all gas appliances are installed and correctly maintained by a competent person and in accordance with the latest regulations.

### 1.2 ELECTRICAL SUPPLY

Please ensure that this appliance has been properly connected to the electrical supply by means of a double pole isolator or un-switched socket, and that the correct size of fuse (3 amp) has been fitted.

**Warning: this appliance must be earthed!**

### 1.3 GUARANTEE REGISTRATION CARD

Please take the time to fill out your guarantee registration card. The completed warranty card should be posted within 30 days of installation.

### 1.4 BENCHMARK LOG BOOK

The **Benchmark** Log Book is supplied with your boiler. This important document must be completed during the installation/commissioning of your boiler. All CORGI Registered Installers carry a CORGI ID card and have a registration number. Both should be recorded in your **Benchmark** Log Book. You can check your installer by calling CORGI direct 01256 372300. Failure to install and commission the appliance in accordance with the manufacturers instructions may invalidate the warranty. This does not affect your statutory rights.

### 1.5 HOW DOES IT WORK?

Your Pinnacle boiler is a high efficiency central heating boiler, which supplies heated water to your radiators and hot water cylinder.

The central heating and hot water is controlled via a programmer and any thermostats that your installer may have fitted. The Pinnacle boiler

lights electronically and does not have a pilot light. In the unlikely event of a fault developing with your boiler, the supply of gas to the burner will be terminated automatically.

### 1.6 DIMENSIONS

HEIGHT	820 mm
WIDTH	450 mm
DEPTH	355 mm

### 1.7 CLEARANCES REQUIRED

ABOVE	150 mm
BELOW	120 mm
SIDES	12 mm
FRONT	600 mm

### 1.8 FROST PROTECTION SYSTEM

The Pinnacle is equipped with a built-in frost protection system, this enables the boiler to override the time controls – if switched off – and operate the burner and/or pump, should the temperature drop below 7 °C.

Please note that the frost protection system is designed to protect the appliance only, should frost protection be required for the central heating system, additional controls may be required.

#### **NOTE**

The frost protection system is reliant on the appliance having a permanent electrical supply, and being in a non-fault condition.

---

## GETTING STARTED

---

### 2.1 BEFORE SWITCHING ON

Before switching the appliance on please familiarise yourself with:

- how to isolate the appliance from the gas, water, and electricity supplies;
- how to check and top-up – if necessary – the system water pressure;
- the time clock or programmer;
- any external thermostats and their functions;
- the appliance controls.

### 2.2 APPLIANCE CONTROLS (fig. 1)

The appliance controls are concealed behind the front cover. To gain access to the controls simply press the cover inwards to release the catch. The appliance is equipped with a simple keypad that can be used to alter the following function:

- the outlet flow temperature to the central heating system and hot water cylinder;

The pressure gauge shows the current pressure of the system, the gauge should be set between 1 and 1.5 bar. When the appliance is operating the gauge may rise or fall slightly, this is quite normal. The minimum permissible level for the safe and efficient operation of the appliance is 0.5 bar. Should the pressure fall below 0.5 bar, the boiler may lockout.

Depending on the type of controls specified by your installer you may have an integral Vokera time clock fitted to the appliance, if so, instructions can be found on page 8-9. If an external time clock or programmer has been fitted, please refer to the instructions supplied with such.

## 2.3 LIGHTING THE BOILER

Ensure the gas and electrical supply to the boiler are turned on. The boiler will now go through a self-test and purge sequence indicated by the letter 'A' shown on the left side of the digital display.

### 2.3.1 ON/OFF MODES

The heating mode can be switched ON or OFF at the boiler irrespective of the current programmer setting. This is indicated by the status LED (fig. 1).

If the status LED is permanently illuminated green, this indicates that the heating mode is enabled and is controlled via the programmer and any external controls such as a room thermostat or cylinder thermostat.

If the status LED is flashing green, the boiler will not respond to any heat requests from the programmer or room thermostat etc. (only frost protection is active).

To switch the heating mode ON or OFF, press and hold the  button (fig. 2) whilst looking at the digital display:

- **c** **OF** indicates the heating mode is switched OFF
- **c** **55** (or any other number, indicating the central heating operating temperature), indicates the heating mode is switched ON.

### 2.3.2 HEATING REQUEST

When there is a demand for heating via the programmer, the boiler will go through an ignition sequence, whereby the burner will light. When the appliance reaches the set temperature, the burner will go off for minimum period of approximately 90 seconds. When the programmer/time clock or external thermostats heating request has been satisfied, the appliance will switch off automatically.

#### NOTE

If the appliance fails to ignite during the ignition sequence, it will re-attempt ignition several times before going to a lockout condition. Should this occur, please allow a period of two minutes before re-setting.

### 2.3.3 STATUS LED (fig. 1)

The appliance status LED indicates whether the boiler is in OFF mode, ON mode or fault condition.

#### Status LED flashing Green

Indicates the appliance is in the OFF mode, with electrical supply and frost protection active.

#### Status LED permanently Green\*

Indicates the appliance is ON mode, with heating or hot water or both activated.

#### Status LED permanently Red





This indicates that the appliance is in a permanent fault condition and may require to be reset (indicated by the relevant fault code displayed) see section 2.6.

\*Also illuminated during a temporary fault condition.

## 2.4 ADJUSTING THE OPERATING TEMPERATURE

Usually your installer will have adjusted the operating temperatures to suit your requirements, however should you wish to view or alter them, please use the following procedure:

#### Operating temperature

- to view or alter the heating operating temperature, briefly press the  button;
- the operating temperature will be shown on the right side of the display (see fig. 2);
- use the  or  button to adjust the operating temperature if required;
- press the  button to save the new setting.

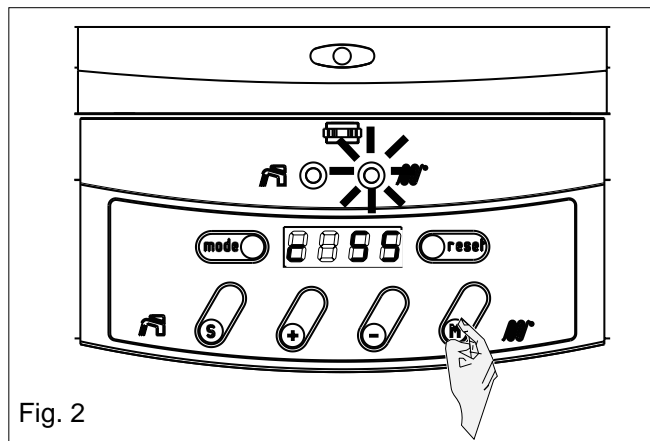

Fig. 2

## 2.5 DIGITAL DISPLAY

The digital display shows the current mode of operation and/or status of the boiler.

Should a fault develop, the display will show a unique fault code that can be used to help rectify the cause of the fault. During the normal operation, the left side of the display indicates the current mode of operation, whilst the right side will show the current temperature.

Left display shows	Current status
0	Stand-by mode
1	Purging
2	Ignition
3	Heating mode
4	N/A
5	Fan operation
6	Timer delay
7	Pump over run
8	N/A
A	Self check

#### Displays during normal operation

Should a fault occur, the left side of the display will show whether the fault is temporary or permanent (indicated by 'b' or 'E'), whilst the right side of the display indicates the unique fault code.

**Should a fault code be displayed, check the fault code table to identify the cause and course of action to take. Always wait 2-minutes before pressing the reset button.**

## 2.6 FAULT CODE TABLE

Code	Reason	Action required
E 00	Ignition anomaly	Reset appliance, if fault continues, call engineer
E 02	No flame detected	Check gas is on, reset appliance, if fault continues, call engineer
E 03	Internal fault	Call engineer
E 04	Power failure	Reset appliance, if fault continues, call engineer
E 05	Internal fault	Call engineer
E 06	Internal fault	Call engineer
E 07	Internal fault	Call engineer
E 11	Internal fault	Call engineer
E 12	Appliance overheat	Reset appliance, if fault continues, call engineer
E 13	Internal fault	Call engineer
E 14	Internal fault	Call engineer
E 15	Internal fault	Call engineer
E 16	Internal fault	Call engineer
E 17	Internal fault	Call engineer
B 18	Appliance overheat	Ensure radiators are on
E 18	Appliance overheat	Reset appliance, if fault continues, call engineer
B 19	Appliance overheat	Ensure radiators are on
E 19	Appliance overheat	Reset appliance, if fault continues, call engineer
B 24	Temperature anomaly	If fault continues, call engineer
B 25	Temperature anomaly	Check pressure gauge
E 25	Temperature anomaly	Check pressure gauge, reset appliance, if fault continues, call engineer
B 26	Condensate pipe blocked	Check outlet of condense pipe, if problem persists, call engineer
B 28	Insufficient fan speed	If fault continues, call engineer
E 28	Fan problem	Reset appliance, if fault continues, call engineer
B 29	Fan speed problem	If fault continues, call engineer
E 29	Fan problem	Reset appliance, if fault continues, call engineer
B 30	Temperature anomaly	Check pressure gauge
E 30	Temperature anomaly	Check pressure gauge, reset appliance, if fault continues, call engineer
E 31	Internal fault	Call engineer
E 32	Internal fault	Call engineer
E 33	Internal fault	Call engineer
E 36	Internal fault	Call engineer
E 37	Internal fault	Call engineer
E 38	Internal fault	Call engineer
E 44	Internal fault	Call engineer
E 60	Programming fault	Call engineer
B 65	Insufficient fan speed	If fault continues, call engineer

## HOW TO...

### 3.1 HOW TO TOP-UP THE SYSTEM PRESSURE (fig. 3)

The system pressure must be checked periodically to ensure the correct operation of the boiler. The needle on the gauge should be reading between 1 and 1.5 bar when the boiler is in an off position and has cooled to room temperature. If the pressure requires 'topping-up' use the following instructions as a guide.

- Locate the filling valve connections (usually beneath the boiler).
- Attach the temporary filling connection to both control valves.
- Open both control valves slowly until you hear water entering the system.
- Close the control valves when the pressure gauge (on the boiler) reads between 1 and 1.5 bar.
- Remove the temporary connection from the control valves.

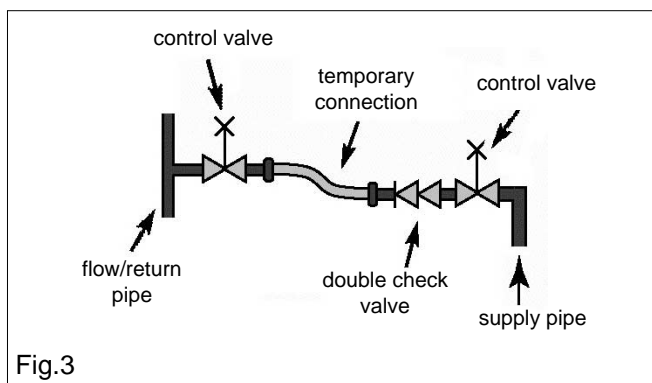

Fig.3

### 3.2 HOW TO RESET THE APPLIANCE

When the status light is illuminated red, the appliance will require to be reset manually. Before resetting the boiler ensure that the pressure gauge is indicating the correct level. Allow a period of two minutes to elapse before pressing the reset button.

#### IMPORTANT

If the appliance requires to be reset frequently, it may be indicative of a fault, please contact your installer or Vokera Customer Services for further advice.

### 3.3 HOW TO SHUT DOWN THE SYSTEM FOR SHORT PERIODS

The system and boiler can be shut down for short periods by simply turning the time clock to the off position. It is also advisable to turn off the main water supply to the house.

### 3.4 HOW TO SHUT DOWN THE SYSTEM FOR LONG PERIODS

If the house is to be left unoccupied for any length of time – especially during the winter – the system should be thoroughly drained of all water. The gas, water and electricity supply to the house should also be turned off. For more detailed advice contact your installer.

### 3.5 HOW TO CARE FOR THE APPLIANCE

To clean the outer casing use only a clean damp cloth. Do not use any scourers or abrasive cleaners.

## WHAT IF...

### 4.1 WHAT IF I SUSPECT A GAS LEAK

If you suspect a gas leak, turn off the gas supply at the gas meter, and contact your installer or local gas supplier. If you require further advice please contact your nearest Vokera office.

### 4.2 WHAT IF I HAVE FREQUENTLY TO TOP-UP THE SYSTEM

If the system regularly requires topping-up, it may be indicative of a leak. Please contact your installer and ask him to inspect the system.

### 4.3 WHAT IF THE STATUS LED IS RED

If the reset light is on it indicates that the boiler has failed to ignite or has overheated, when this happens the boiler automatically shuts down and requires to be reset manually (see section 3.2).

### 4.4 WHAT IF THE APPLIANCE IS DUE ITS ANNUAL SERVICE

#### Advice for tenants only

Your landlord should arrange for servicing.

#### Advice for homeowners

Please contact Vokera Customer Services (**0870 333 0220 (UK) or 05655057 (ROI)**) if you would prefer a Vokera service engineer or agent to service your appliance. Alternatively your local CORGI registered engineer may be able to service the appliance for you.

### 4.5 WHAT IF I NEED TO CALL AN ENGINEER

If you think your boiler may have developed a fault please contact your installer or Vokera Customer Services (**0870 333 0220 (UK) or 05655057 (ROI)**) have all your details to hand including full address and postcode, relevant contact numbers, and your completed appliance log book.



# VOKERA TIMECLOCKS

## 5.1 VOKERA MECHANICAL CLOCK

### Setting the time

The time of day can be set by grasping the outer edge of the black dial and turning it in a clockwise direction until the correct time is in line with the white pointer.

### Setting the 'switching times'

The 'ON' periods are set by sliding the black tappets, adjacent to the time periods required, to the outer edge of the dial.

The tappets that remain at the centre of the dial will be the 'OFF' periods.

The smallest switching time (ON or OFF) is 15 minutes.

To select 'Timed' mode move the selector switch in the middle of the clock face to the '⌚' position.

To select 'Constant' mode move the selector switch in the middle of the clock face to the 'I' position.

To select 'Off' mode move the selector switch in the middle of the clock face to the 'O' position.

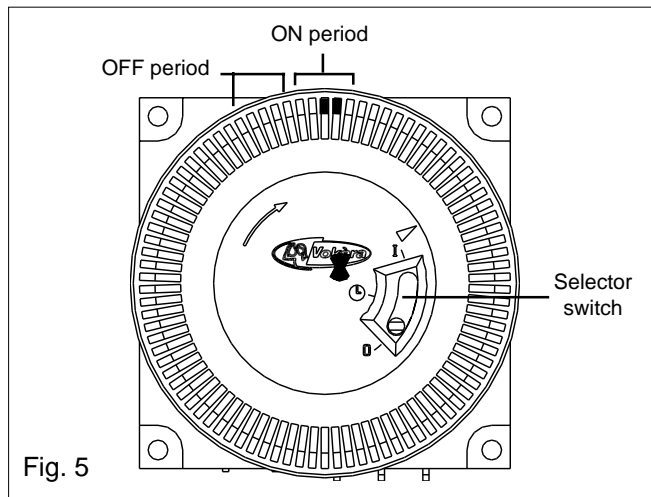

Fig. 5

## 5.2 VOKERA DIGITAL CLOCK

The Vokera digital time clock will automatically switch your boiler on and off. It has a total of twenty different switching commands, consisting of ten 'on' commands and ten 'off' commands.

Each 'on' or 'off' command can be used to switch the boiler 'on' or 'off' at the same time:

- Every day of the week
- Monday to Saturday
- Monday to Friday
- Saturday and Sunday
- Any particular day

### Example

Group of days	On	Off	Commands used
Mon. to Fri.	06.00	09.00	2
Mon. to Fri.	16.00	21.00	2
Sat. & Sun.	08.30	10.30	2
Sat. & Sun.	17.00	23.00	2
		Total	8 used
Commands 'free'			12 unused

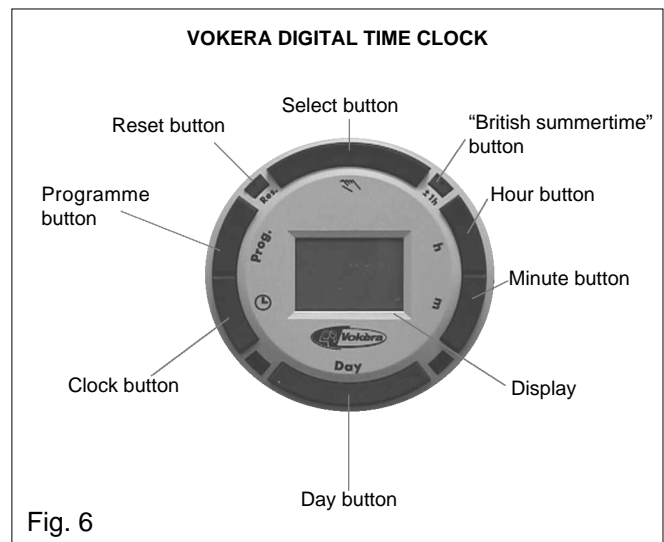

Fig. 6

### 5.2.1 BEFORE PROGRAMMING

Gently press and release the 'Res.' button with a pencil or similar, this will clear the memory of all information. This should only be done when you want to change or insert a complete new programme.

### 5.2.2 SETTING THE TIME OF DAY

The 'real time' clock has to be set to the actual day of the week and time of day, to do this:

- Press and hold the ⌚ button (see fig 7).
- Press the 'Day' button until the actual day shows in the display (1= Monday, 2= Tuesday, 3= Wednesday, etc.).
- If setting the clock during 'British summertime' press the '+/-1h' button once (use a pencil or similar).
- Press the 'h' button until the actual hour is shown in the display.
- Press the 'm' button until the actual minutes are showing in the display.
- Now release the ⌚ button.
- The ':' symbol between the hours and minutes display will start to flash, this indicates that the clock is now keeping time (see fig. 8).

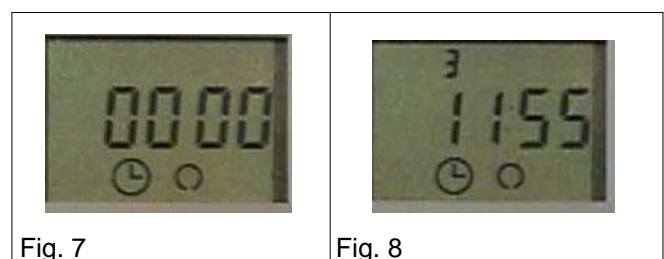

Fig. 7

Fig. 8

### 5.2.3 ENTERING Ⓞ (on) COMMANDS

- Repeatedly press the Prog. Button until the — :— symbol appears in the clock display (see fig. 9).
- Press the Day button until the desired group of days or desired day is shown.
- Press the 'h' button until the desired hour for switching the boiler on is shown.



- Press the 'm' button until the desired minutes are shown.
- Press the Select button until the  symbol is shown (see fig. 10).
- Press the  button.





Fig. 9



Fig. 10

#### 5.2.4 ENTERING (off) COMMANDS

- Repeatedly press the Prog. Button until the — :— symbol appears in the clock display (fig. 5).
- Press the Day button until the desired group of days or desired day is shown.
- Press the 'h' button until the desired hour for switching the boiler off is shown.
- Press the 'm' button until the desired minutes are shown.
- Press the Select button until the  symbol is shown (see fig. 11).
- Press the  button.





Once the programming has been completed you will have to press the Select button – once only – to the  (on) position if the boiler has been programmed to be 'on' at that particular time.



Fig. 11

#### 5.2.5 ADVANCING OR LOCKING PROGRAMME COMMANDS

By pressing the Select button you can advance the time clock to the next command setting (from 'on' to 'off' or 'off' to 'on') or lock the time clock to a particular command ('on' continuously or 'off' continuously).

-  - ON
-  - OFF
- [] – ON CONTINUOUSLY
- [] – OFF CONTINUOUSLY

#### NOTE

The actual time can be changed to account for British summertime by simply pressing then releasing the +/- 1h button.

#### HELPFUL HINTS

- You can check and/or alter the programme settings at any time by pressing the Prog button.
- The number of unused 'commands' can be checked by pressing the Prog button until FR is displayed alongside the number of unused commands.
- In the event of a power failure, the clock has a battery back-up. The programme will be held in the memory for approximately 2 weeks. Charging time is 70 hours.
- Take a note of the settings you have programmed, as local power surges can sometimes reset the memory of the clock.











**Vokèra Ltd.**

4<sup>th</sup> Floor, Catherine House, Boundary Way, Hemel Hempstead, Herts, HP2 7RP

Email: [enquiries@vokera.co.uk](mailto:enquiries@vokera.co.uk) Web: [www.vokera.co.uk](http://www.vokera.co.uk)

Sales, Technical Advice, General Enquiries - Tel: 0870 333 0520 Fax: 01442 281403

After Sales Service - Tel: **0870 333 0220**

**Vokèra Ireland**

West Court, Callan, Co Kilkenny

Tel: **05677 55057** Fax: **05677 55060**

Vokèra Ltd. reserve the right to change the specifications without prior notice. Consumers' statutory rights are not affected.

**A Riello Group Company**



"Vokèra"  
supports Benchmark