



Vokèra

▲ DOMESTIC HEATING APPLIANCES

EXCELL 80E & 96E

Users Instructions

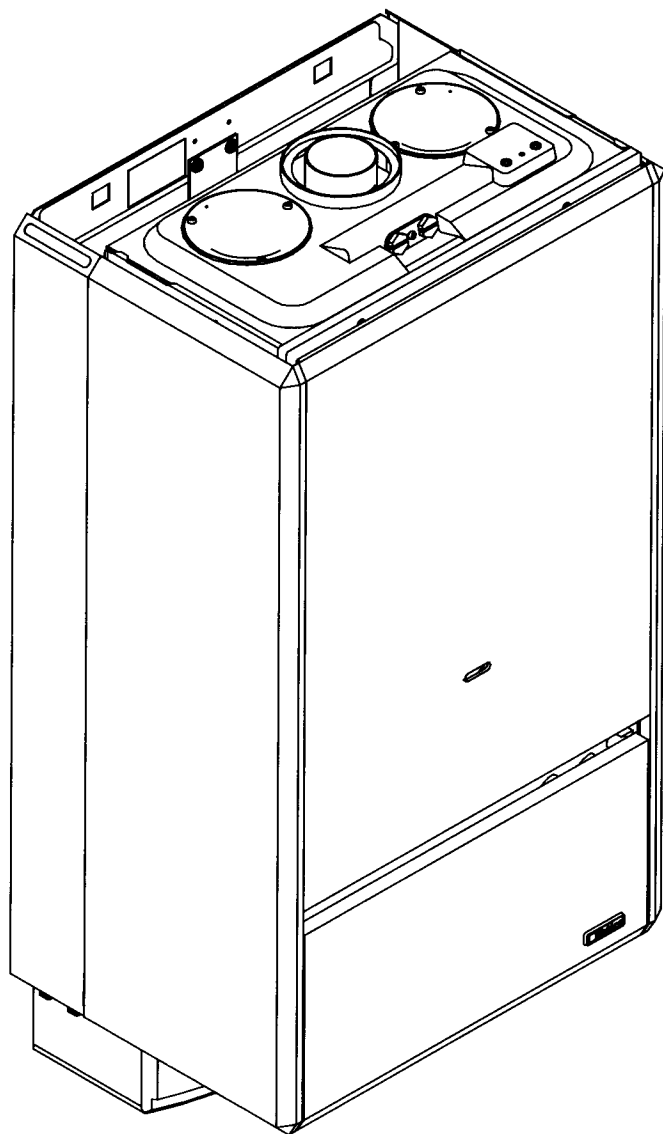

Tested and Certified
63 AO 0640 (N/G)
63 AQ 0640 (LPG)

British Gas Service Listed
80E G.C. No. 47 094 18
96E G.C. No. 47 094 19

WRc No. 9502032

**HAND THESE
INSTRUCTIONS
TO THE USER**

BEFORE ATTEMPTING TO LIGHT APPLIANCE PLEASE MAKE SURE THAT IT IS CHARGED UP WITH WATER WITH THE NEEDLE POINTING AT 1bar ON THE PRESSURE GAUGE (8)

Gas Safety (Installation and Use) Regulations 1994

In your own interests and that of safety, it is the law that all gas appliances are installed and serviced by a competent person in accordance with the regulation.

GAS LEAK OR FAULT

IF A FAULT OR GAS LEAK IS SUSPECTED, TURN OFF THE APPLIANCE AND CONTACT YOUR INSTALLATION COMPANY OR LOCAL GAS REGION.

INTRODUCTION

Your Vokera Excell is a central heating boiler supplying central heating and instantaneous domestic hot water only. In the winter when both Central Heating and Hot Water are needed the central heating circulation stops when hot water is being drawn off. This normally will not affect the level of heating.

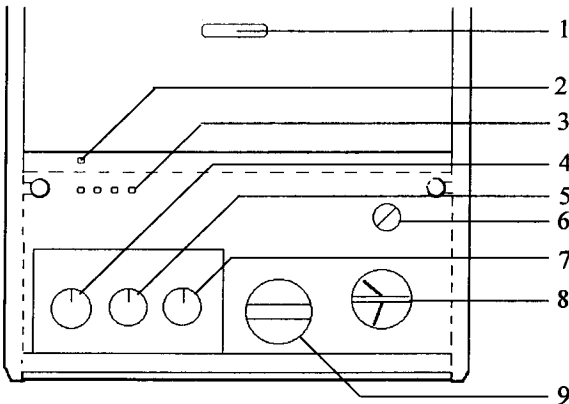

Boiler Location

Clearances

Minimum - above casing 225mm (9in)

Minimum - below casing 150mm (6in)

Minimum - In front 600mm (24in)

Minimum - At sides 12mm (½in) from casing

If the appliance is fitted in a compartment it should not be used as a storage cupboard (e.g. for food).

NEVER HANG CLOTHES ETC. OVER THE APPLIANCE.

1. Pilot sight Glass
2. Status L.E.D. green = normal, red = fault.
3. Diagnostic L.E.D.'s.
4. On/Off and Mode Selector switch.
5. Central Heating Temperature control.
6. High Limit reset button.
7. Hot Water Temperature control.
8. Temperature/Pressure gauge.
9. Timeclock aperture (optional)

ELECTRICITY SUPPLY

WARNING:

THIS APPLIANCE MUST BE EARTHED

Connection should be made to a 230v 50Hz supply. The appliance must be protected by a 3amp fuse if a 13amp (BS 1363) plug or fused spur is used.

To connect a plug:

As the colour of the wires in the mains lead to this appliance may not correspond with the coloured markings identifying the terminals in your plug, proceed as follows:-

The wire which is coloured green-and-yellow must be connected to the terminal in the plug which is marked with the letter E or by the earth symbol ⏏ or coloured green or green-and-yellow.

The wire which is coloured blue must be connected to the terminal which is marked with the letter N or coloured black

The wire which is coloured brown must be connected to the terminal which is marked with the letter L or coloured red.

Lower the controls fascia cover at front of the appliance.

1.0 Hot Water Only

Ensure electricity Supply is on.

1.1 With the boiler ON/OFF/Mode selector switch turned to  the main burner will ignite whenever water is drawn from the tap. (view through sight glass)

1.2 Should the boiler fail to ignite turn the On/Off / Mode selector switch to the reset position  for a period of at least 10 seconds then turn back to the original position before drawing water again.

1.3 The temperature of water at the tap can be varied by adjusting the water flow rate at the tap. The Hot Water Temperature control (7) will govern the maximum temperature. Setting 1 approx 60° C Setting 9 approx 80° C. The temperature gauge (8) indicates the temperature of the central heating water, not the tap water.

2.0 Heating and Hot Water
Ensure Electricity is ON.

2.1 With the boiler ON/OFF/Mode selector switch turned to  (if external controls are fitted e.g. timeclock and/or room thermostat ensure they call for heat) the boiler will now go through an ignition sequence and the burner will light. (view through sight glass 1).

2.2 Should the boiler fail to ignite turn the boiler ON/OFF/Mode selector switch to  for a period of at least 10 seconds and repeat 2.1 above.

2.3. Adjust the Central heating temperature control (5) to suit the weather, 1 is the lowest setting, 9 is the highest.



N.B (i) For the quickest heat up of the premises the highest setting is needed at first, turning down later.
(ii) When Room Thermostats are used it may be best to leave the boiler thermostat at a high setting and set the room thermostat as required.

3.0 SAFETY LIMITS

3.1 Systems pressure

The water pressure gauge (8) must read between 1bar and 1.5 bar when the system is cold. Leaks or radiator venting will reduce this. Call in your service installer if excessive topping up of the system to restore pressure is necessary. A built-in safety valve operates if boiler pressure exceeds 3bar whether hot or cold. If the safety valve operates (water/steam discharges to drain) switch off and call your Installer or Service Engineer.

3.2 If the appliance water temperature rises too high, a high limit thermostat operates to extinguish the burner. This is indicated by the Status L.E.D. flashing red and the L.E.D. marked  will be illuminated.

The high limit thermostat may be reset by first turning the On/Off/Mode switch to 'O' remove the cap marked   and press the reset button in. It may be necessary to wait 5 -10 minutes before this can be done.

If the High Limit thermostat operates again the appliance must be checked by your Installer or Service Engineer.

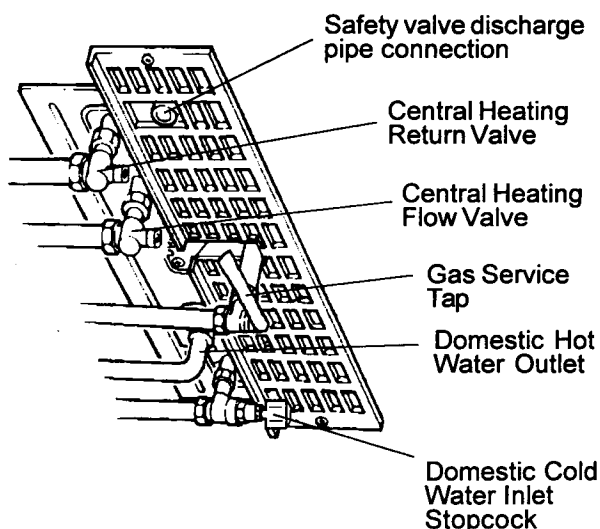

4.0 The 5 neon lights on the appliance control panel serve to identify some faults that may occur within the appliance.

The single neon at the top will normally show green if the appliance is 'on' and no faults are apparent. Should this neon change to red and start flashing it indicates a fault. During an ignition attempt this neon may show red for 1-2 seconds this is quite normal.

The flashing red light will be accompanied by the illumination of one or more of the 4 neons just below it.

Each of the neons indicate a particular fault as given below and will continue to be illuminated until the fault is remedied or the appliance is switched off.



Insufficient system water pressure or poor flow in system. (top up system pressure or call engineer)



Problem with Fan/Flue. (call service engineer)



Overheat. (press overheat reset button if overheat trips again call engineer)



Lockout. (turn on/off /mode selector switch to reset position for approx. 5 seconds)

5.0 SHUTTING DOWN THE SYSTEM

For short periods:

Turn on/off/mode selector switch (2) to 'O'

For longer periods also:

Turn off gas cock and

Turn off main electricity supply to boiler.

However, if the building is vacated when there is risk of freezing shut down the boiler as described and drain the system: Open all heating radiator valves and drain through the cocks usually provided at the lowest point of the system. To ensure draining of radiators open radiator air cocks remembering to close them when the operation is complete.

Alternatively, install a frost stat and leave the mains electricity and gas supply turned on.

N.B. Refilling a sealed system must be undertaken by a competent person following approved procedures.

6.0 RELIGHTING THE BOILER

Relight by following steps 1.0 or 2.0 given previously, after ensuring that refilling of the sealed system has been carried out.

7.0 CLEANING THE OUTER CASE

Use a clean damp cloth. Do not use abrasive cleaners.

8.0 SPARE PARTS AND SERVICING

Your Vokera Excell must be serviced annually. Please contact your local Vokera Service Agent, your local Gas Region or a competent Installer.

VOKERA TIME CLOCKS

Mechanical 24 hr Version

Setting the time.

The time of day can be set by grasping the outer edge of the black dial and turning it in a clockwise direction until the correct time is in line with the white pointer.

Setting the 'switching times'

The 'ON' periods are set by sliding the green tappets, adjacent to the time periods required, to the outer edge of the dial.

The tappets that remain at the centre of the dial will be the 'OFF' periods.

N.B. The smallest switching time (ON or OFF) is 15 minutes.

Digital 7 Day version.

The Vokera digital clock has the normal individual daily setting facility and a group timing feature.

Group timing allows for any single time slot of the 16 available to be repeated over one of the following three periods:-

MONDAY TO SUNDAY

MONDAY TO FRIDAY

SATURDAY AND SUNDAY

N.B. The display will not show until the clock has been connected to mains power for approximately two minutes.

NOTE: Always operate the reset button before attempting to programme the timer.

The reset button should also be used if the timer's memory becomes corrupted by mains interference which, dependent on location, may be present from time to time. Mains interference can cause the timer to display incorrect information and/or appear to have developed a fault.

USE OF THE TIMER

Setting the time

1. Press and hold 'button whilst carrying out steps 2, 3 and 4.
2. Set hour of day using **h+** button.
3. Set minute of day using **m+** button.
4. Set day of week by repeatedly pressing button marked **Day**
5. Releasing 'button starts time switch running.

ATTENTION! If keys **h+** or **m+** are kept depressed for longer than 2 seconds, a rapid advance of figures will result.

Before entering any programme draw up a chart to arrange the settings required and enter in a chronological order; as on read back the programme displays in the order of entry.

TO PROGRAMME 'SWITCHING' ON TIMES

- (a) Press button marked '**CH1**' once. The time of day - as set - disappears from the display.
- (b) Press button marked '**DAY**' until the day or group of days requiring setting are displayed.
- (c) Set the 'ON' time of programme required by using '**h+**' and '**m+**', buttons for hours and minutes. Please read the notes at the end of these instructions if you wish this switching time to be carried out on several days.

Again press button marked '**CH1**', so that the command will be incorporated in the programme storage compartment.

— will appear.

CH1 OFF

TO PROGRAMME 'SWITCHING OFF' OFF TIMES

Now insert the 'OFF' time of the programme required using '**h+**' and '**m+**', buttons for hours and minutes.

- (b) Press button marked '**Day**' until the day or group of days requiring setting are displayed.

(c) In order to insert further switching times 'ON or OFF'-press 'CH1' button once or several times

respectively. The display shows a vacant storage space; for instance,

—:— will appear.
CH1 ON

Input of 'ON/OFF' times as described above may be carried out. Eight 'ON/OFF' programmes can be set. Press the button marked '1' on completion of programme settings.

NOTES: MULTIPLE WEEK-DAY SWITCHING GROUPS

It is possible to combine switching commands within the switching time programme if they are to be executed at the same time on different days of the week. For this purpose your Digital time clock offers the following possibilities.

Constant daily repetition:

Monday - Sunday (Mo-Su)

Week-days only:

Monday-Friday (Mo-Fr)

Week-ends only:

Saturday + Sunday (Sa-Su)

These weekday combinations can be called up with key 'Day' (for instance Mo, Tu, We, Th, Fr) during the programming operation of switching times. Thus switching time carried out for instance Monday - Friday at 13.00 hrs requires only one storage space.

Alterations are carried out by 'overwriting' of the individual command. To achieve this, follow the procedure for 'SWITCHING ON AND OFF' (Programming of switching times).

CANCELLATION OF SWITCHING COMMANDS

If keys 'h+' and 'm+' are used to overwrite a switching command in such a way that the hour and/or minute area in the display shows the symbol —:—, the input is no longer effective, but it remains in the storage compartment as an inactive part.

SWITCHING CONDITION INDICATION

The actual switching condition is shown in the displays as 'ON' or 'OFF' together with the time of day.

PRE-SELECTION SWITCH (Hand Symbol)

This key has 4 functions

Press once:

Advancement of next switching command:

ON and OFF respectively

Press again:

Indication in display: **FIX ON** = Constant Heating.

Press again

Indication in display: **FIX OFF** = No heating.

Press again

Indication in display: **AUTO** = Timed heating

SUMMER TIME / WINTER TIME CHANGEOVER

From winter time to summer time: Depress key 1 h briefly once (Display shows symbol +1 h)

From summer time to winter time: Depress key 1 h briefly once (Symbol +1 h disappears from display)

RUNNING RESERVE

In the case of mains electricity failure, the internal battery ensures that the actual time of day continues to operate and that the automatic switching programme remains intact. The instrument can be programmed completely even without mains supply, provided the back-up battery is fully charged (charging time 70 hours).



Vokèra Ltd

Head Office and Accounts: Clarisham House, Morson Road, Enfield, Middlesex EN3 4NQ - Tel. 0181/8047202 Fax 0181/8048163

Northern Region: Stubs Beck Lane, West 26 Business Park, Whitehall Road, Cleckheaton, West Yorkshire BD19 4TT - Tel. 01274/865556 Fax 01274/865557

Scottish Region: Shuna Street, Maryhill, Glasgow G20 9NW - Tel. 0141/9454944 Fax 0141/9455136