

BAXI FIRES DIVISION

CHIC HEAT BAFFLE ADDENDUM

This addendum is for use with the **Model 541** fitted with a CHIC fascia. It must be read in conjunction with the installer and owner guide supplied with the gas fire.

As part of our policy of constant development and improvement, the upper heat baffle on the CHIC model has been updated. The baffle has been extended and has two fascia securing holes. This may already be fitted to the fire or supplied separately.

How do I know if I have an updated upper heat baffle?

The updated heat baffle can be identified as in figure 1.

Fitting heat baffles that are supplied as loose parts.

- If your fire is already fitted with an updated heat baffle then proceed to the next section.
- Unscrew and remove the heat baffle fitted to the fire. To do this remove the central screw (See figure 2).
- Fit the replacement baffle using the screw removed previously.

Fitting the Chic fascia.

- There are two trim securing screws on the top underside of the Chic fascia (See figure 3). Unscrew and remove these screws.

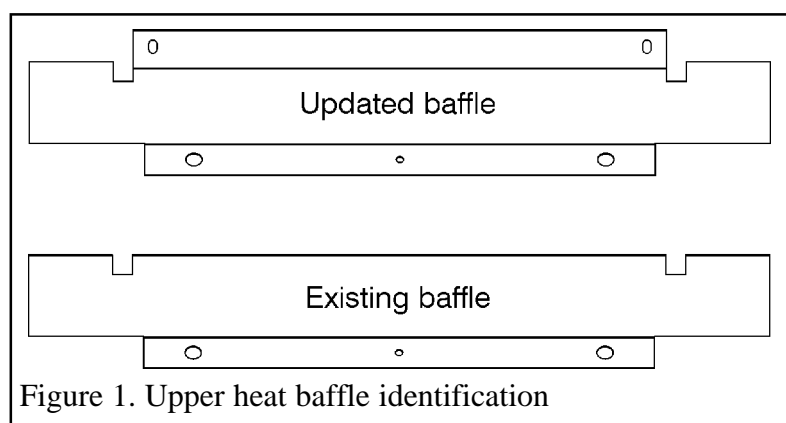

Figure 1. Upper heat baffle identification

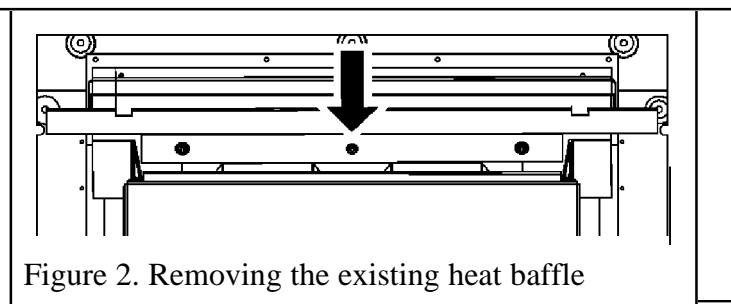

Figure 2. Removing the existing heat baffle

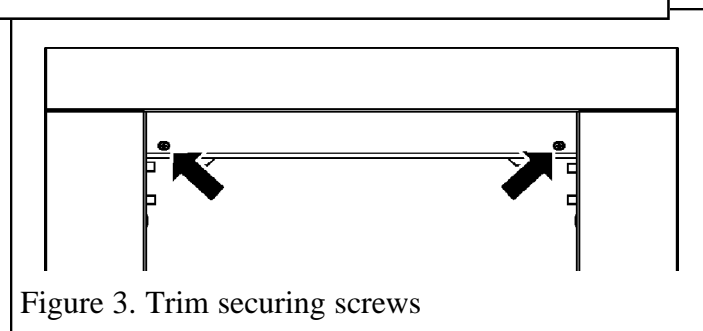

Figure 3. Trim securing screws

BAXI ● VALOR ● WONDERFIRE

INSTALLER AND OWNER GUIDE

- Remove any protective film from the fascia.
- Locate the two lugs at the top of the fascia in the slots in the convection box hood. Swing the bottom of the fascia sides back against the convection box and lower the fascia so that the lugs are fully seated in the slots in the convection box hood (See figure 4).
- Secure the bottom of the fascia sides to the convection box side brackets using the two screws supplied (See figure 4).

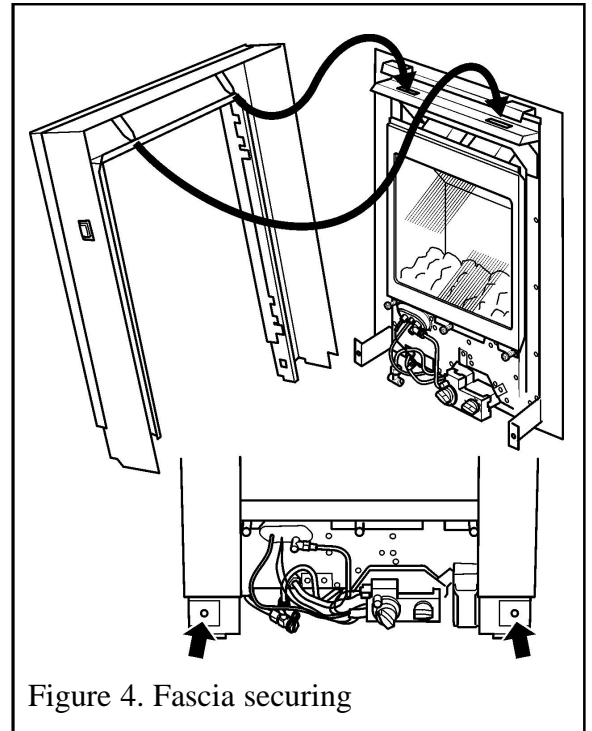

Figure 4. Fascia securing

- Secure the fascia to the upper heat baffle using the two screws removed previously (See figure 5).

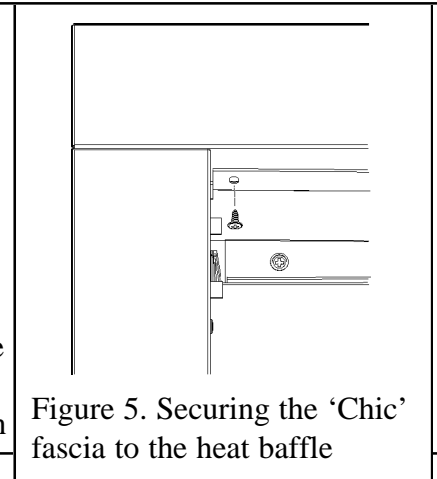

Figure 5. Securing the 'Chic' fascia to the heat baffle

- Supplied in the fascia pack are two tubular trim sets. Hang these to the tabs on the fascia (See figure 6).
- The lower section of the fascia is secured with magnets. Locate it as in figure 7. The bottom of the lower section should sit on the tags as shown.

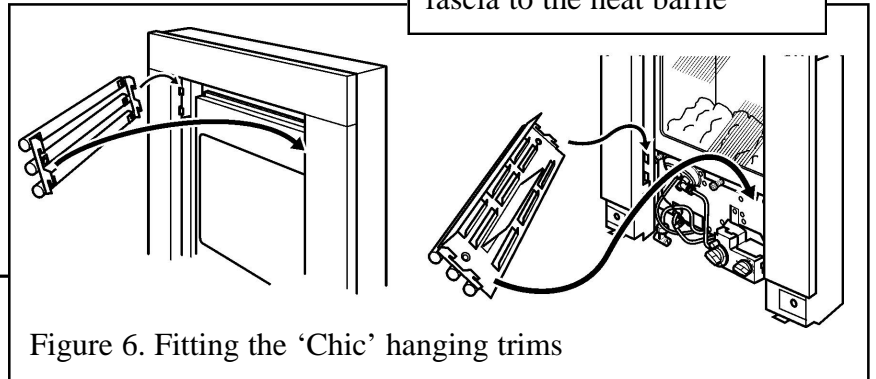

Figure 6. Fitting the 'Chic' hanging trims

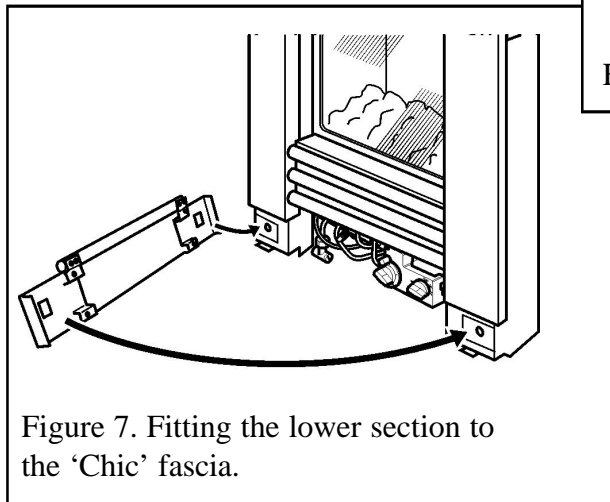

Figure 7. Fitting the lower section to the 'Chic' fascia.