

For the owner and the heating engineer



Operating and Installation Manual VRT 230



Programmable room thermostat

GB

Contents

Notes on the documentation	4
Symbols used.....	4
Storage of the documents.....	4
Safety	5
Operating manual	6
1 Room thermostat overview	6
2 Display overview	7
3 Description of the appliance	8

4 Operation	8
4.1 Setting the operating modes	9
4.2 Setting the current day and time	10
4.3 Setting the heating times	11
4.4 Setting the room temperature ...	14
4.5 Activating special functions.....	15
4.6 Info level.....	17
5 Vaillant warranty	18
6 Recycling and disposal	18

Installation manual	19	10 Electrical installation.	24
7 Information on installation and operation	19	10.1 Connecting the room thermostat.....	24
7.1 CE label.....	19	10.2 Connecting the teleSWITCH (if available).....	25
7.2 Intended use.....	19	11 Start-up.	26
8 Safety instructions and regulations	20	11.1 Installer level.....	26
8.1 Safety instructions	21	11.2 Service/diagnostic level.....	28
8.2 Regulations.....	21	11.3 Handing over to the owner.....	29
9 Installation	22	12 Technical data.	30
9.1 Place of installation.....	22	13 Vaillant customer service	30
9.2 Mounting the room thermostat..	22		

Notes on the documentation

The following information is intended to help you throughout the entire documentation.

Other documents apply in combination with this installation and operation manual.

We accept no liability for any damage caused by failure to observe these instructions.

Symbols used

Please observe the safety instructions in this manual for the installation of the appliance.



Danger!

Immediate risk of serious injury or death

- Symbol for a necessary task

Storage of the documents

Please pass on this operating and installation manual to the owner of the system in order for him/her to store it so that it is available whenever it is required.

Safety

The room thermostat must be installed by an approved company specialised in heating engineering, which is responsible for the observance of the following standards and regulations.

We accept no liability for any damage caused by non-observance of these instructions.

Operating manual

1 Room thermostat overview

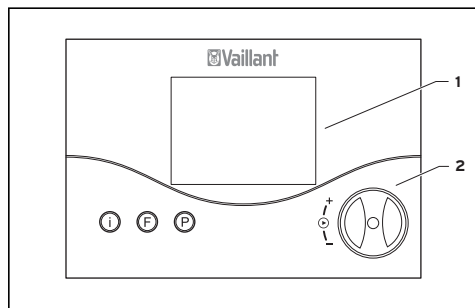

Fig. 1.1 Room thermostat overview

Key

- 1 Display
- 2 Dial (turn and click)
- I Info button
- F Special functions button
- P Programming button/installer level

2 Display overview

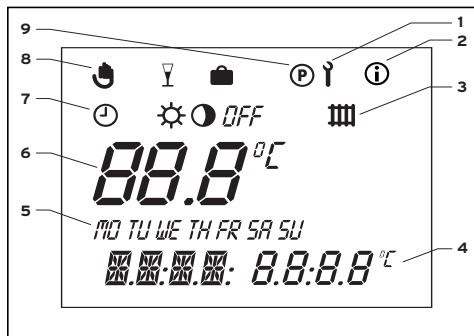

Fig. 2.1 Overview of display

Key

- 1 Installer level and service/diagnosis level
- 2 Info level
- 3 Heating circuit symbol
- 4 Time / temperature display
- 5 Days of the week
- 6 Actual temperature
- 7 Operating modes
- 8 Special functions
- 9 Timer programming

3 Description of the appliance

The VRT 230 is a programmable room thermostat with weekly heating program for connecting to Vaillant boilers.

The VRT 230 enables you to specify the room temperature using heating programs. You can also use special functions such as the party function.

4 Operation

The operating principle uses three buttons and an dial (Vaillant “Turn and Click” operating concept).

The display normally shows the current operating mode (e.g. ☀ ⚙), or, if activated, the respective special function and the current room temperature, the day of the week, the time and the heating circuit symbol, if heating is required.

4.1 Setting the operating modes

Table 4.1 contains an overview of the operating modes you can select.

- When the room thermostat is in normal display mode, press the dial once - the symbol for the selected mode flashes in the display.
- Turn the dial until the display shows the operating mode you want.

The display switches back to normal mode after five seconds.



Symbol	Meaning
	Automatic: According to the timer programmes set in the room thermostat, the heating circuit switches between heating mode ☀ and set-back mode 🌙.
	Heating: The heating circuit is operated according to the room temperature, regardless of the programme set on the room thermostat.
	Set-back: The heating circuit is operated according to the set-back temperature "ECO", regardless of the programme set on the room thermostat.

Table 4.1 Operating modes

4 Operation

Symbol	Meaning
<i>OFF</i>	Off: The heating circuit is off, provided the frost protection function (if the room temperature is below 5 °C) is not activated.

Table 4.1 Operating modes (contd.)

4.2 Setting the current day and time

To set the current day and time with the display in normal mode, you must perform the following steps:

- Press the dial until a day of the week starts flashing.

- Turn the dial until the current day of the week flashes.
MO = Monday
TU = Tuesday
WE = Wednesday
TH = Thursday
FR = Friday,
SA = Saturday
SU = Sunday
- Press the dial. The hours start flashing.
- Turn the dial until you see the current hour.
- Press the dial. The minutes start flashing.
- Turn the dial until you see the current minute.

The display switches back to normal mode after five seconds.
 If the calendar is activated on the installer level, you can set the day, month and year in the same way after you set the time. This allows automatic switching from winter to summer time.

4.3 Setting the heating times

The room thermostat is equipped with a basic program (see table 4.2)

Time window	Day / Block of days	Start time	End time
H 1	MO-FR	6:00	22:00
H 2	–	–	–
H 3	–	–	–
H 1	SA	7:30	23:30
H 2	–	–	–
H 3	–	–	–
H 1	SU	7:30	22:00
H 2	–	–	–
H 3	–	–	–

Table 4.2 Default basic programme

4 Operation

You can adapt the default basic programme to suit your needs. There are five steps to setting the times you want.

1. Press the programming button P
2. Select the time window
3. Select the day or block of days
4. Set the start time
5. Set the end time

You can define three time windows for each day.

For clarification, the individual steps are shown in the following table:

Display	Required steps
	Press the programming button P - the cursor (black triangle) marks the value which can be changed (H1), which also blinks. Select the time window by turning the dial. Settings: H1, H2, H3

Display	Required steps
	<p>Press the dial - the cursor marks the days of week, which also flashes. Select a block of days or a single day of the week by turning the dial.</p> <p>Settings: MO - SU MO - FR SA - SU MO = Monday TU = Tuesday WE = Wednesday TH = Thursday FR = Friday SA = Saturday SU = Sunday</p>



Display	Required steps
	<p>Press the dial - the cursor marks the start time and the hour display flashes. Select the start time by turning the dial. Press the dial again to set the minutes.</p>
	<p>Press the dial - the cursor marks the end time and the hour display flashes. Select the end time by turning the dial. Press the dial again to set the minutes.</p>

Table 4.3 Setting time windows

4 Operation

If necessary, you can switch the room thermostat from the week programme to a daily programme.

- With the display in normal mode, press the F button for 10 seconds. When you programme time windows, days of the week will no longer be displayed.

4.4 Setting the room temperature

The basic display shows the current room temperature.

You can set the required room temperature directly from the basic display. You can also set or change the set-back temperature "ECO" in the basic display.

Setting the required room temperature directly

- Turn the dial (with the display in basic mode).
The current temperature display disappears, the sun symbol is displayed on the mode level and the required room temperature is shown (e.g. TEMP 20.0 °C).
- By turning the dial you can set the required room temperature directly (after 1 second).
The display switches back to normal mode after five seconds.

Setting the set-back temperature "ECO"

- Press the dial several times until ECO appears in the display. The set-back temperature is displayed and starts flashing.
- Turn the dial until the required set-back temperature is displayed (e.g. ECO 15.0 °C).

The display switches back to normal mode after five seconds.

4.5 Activating special functions

Press the F button to access the special functions. You can activate the following functions:

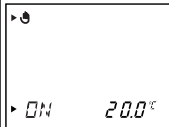
Display	Required steps
 <p>The screenshot shows a digital display with a small icon in the top left corner. Below the icon, the text 'ECO' is displayed on the left and '20.0°C' is displayed on the right. The 'ECO' text is slightly larger and appears to be in a different font style than the temperature.</p>	<p>Quick veto</p> <p>The quick veto function allows you to adjust the room temperature for a short time (until the next time window). Press the special function button F - the quick veto symbol appears in the display along with the quick veto room temperature.</p> <p>Turn the dial until the required quick veto room temperature appears in the display. The display switches back to basic mode after 10 seconds and the function is activated. To deactivate the function, all you need to do is press the F button.</p>

4 Operation

Display	Required steps
	<p>Party function</p> <p>When you activate the party function the heating phase is continued beyond the next set-back phase. Press the special function key two times - the party symbol flashes in the display for ten seconds and the function is activated.</p> <p>The function is deactivated automatically on reaching the next heating phase. If you want to deactivate the function before, just press the F button. This function can only be activated in automatic mode (⌚).</p>

Display	Required steps
	<p>Holiday function</p> <p>The holiday function deactivated the room thermostat, but not the frost protection function. Press the special function button three times - the holiday function symbol flashes in the display. Turn the dial until the required number of days for holiday appears. After 10 seconds the function is activated and the mode is set to OFF for the selected period (see 4.1).</p> <p>If you want to deactivate the function before, just press the F button.</p>

Table 4.4 Special functions

4.6 Info level

Press the info button to access the info level. The info symbol appears in the display as soon as you open the info level. Each time you press the button, different information is displayed:

- The name of the room thermostat (VRT 230)
- The quick veto room temperature (if active)
- The set room temperature (e.g. TEMP 21.5 °C)
- The current set-back temperature (e.g. ECO 15.0 °C)
- The day/month/year (if the calendar is activated)

- The timer programmes set for heating (every single time window per day)

5 Vaillant warranty

We only grant a Vaillant manufacturers warranty if a suitably qualified engineer has installed the system in accordance with Vaillant instructions.

The system owner will be granted a warranty in accordance with the Vaillant terms and conditions. All requests for work during the guarantee period must be made to Vaillant service (0870 6060 777).

6 Recycling and disposal

Neither your room thermostat or any of its accessories belong in the household waste. Make sure the old room thermostat and any accessories are disposed of properly.

Installation manual

7 Information on installation and operation

The assembly, electrical connection, room thermostat settings and commissioning may only be carried out by an approved company specialising in heating engineering.

7.1 CE label

The CE label shows that the VRT 230 room thermostat, when connected to Vaillant boilers, meets the basic requirements of the Council of Europe's directive 89/336/EEC on electromagnetic

compatibility and the low voltage directive 73/23/EEC.

7.2 Intended use

The VRT 230 room thermostat is a state-of-the-art room thermostat which has been constructed in accordance with recognised safety regulations. Nevertheless, there is a risk of death or serious injury to the user or others, and the room thermostat or other property may be damaged in the event of improper use or use for which it is not intended.

The VRT 230 room thermostat is designed to control a heating system according to time and location.

Any other use or extended use is considered to be improper use. The manufacturer or supplier is not liable for any resulting damage. The user alone bears any risk.

Intended use includes the observance of the operating and installation manual.

8 Safety instructions and regulations

The room thermostat must be installed by an approved company specialised in heating engineering, which is responsible for compliance with applicable standards and regulations. We accept no liability for any damage caused by failure to observe these instructions.

8.1 Safety instructions



Danger!

Risk of fatal electric shock from touching live connections.

Before working on the room thermostat, switch off the power supply and prevent it from being switched on again.

Only remove the room thermostat from its wall mounting or base when it is not live.

8.2 Regulations

All wiring must be in accordance with Building Regulations Part P, current IEE regulations, and all other relevant regulations and guidelines, and must be carried out by a suitably qualified person.

Use standard commercial cables for the wiring.

- Minimum wire cross section:
0.75 mm²

The room thermostat may only be installed in dry rooms.

9 Installation

9.1 Place of installation

Install the room thermostat so that it can properly measure the room temperature (avoid heat traps, cold wall etc.). The best place to install it is in the main living area on an interior wall at a height of around 1.5 m. There the room thermostat should be able to record the circulating air, unhindered by furniture, curtains or other objects. Choose a location where the room thermostat is not affected by draughts from doors or windows, or by heat sources such as radiators, chimney walls, televisions and direct sunlight. All the radiator valves in the room where

the room thermostat is installed must be fully open.

9.2 Mounting the room thermostat

Connect the room thermostat to the boiler using a 3-core cable to terminals 3-4-5 (see fig. 9.1, item 2).

- Pull the room thermostat (**1**) out of the mounting box (**5**).
- Open the inner protective cover (**6**) of the wall mounting box (**5**), by undoing the screw (**7**) and lifting the cover to the right.

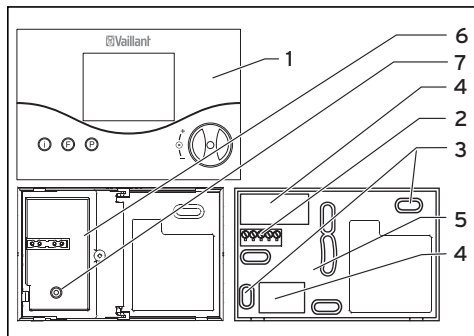

Fig. 9.1 Mounting the room thermostat

- Drill two holes (**3**) of 6 mm diameter (as shown in fig. 9.1) and put in the supplied wall plugs.

- Thread the cable through the cable entry (**4**) below the inner protective cover.
- Fix the mounting box to the wall with the two screws provided.
- Connect the cable as described in 10.1.
- Push the inner protective cover back to the left and fasten it with the screw.
- Place the room thermostat (**1**) on the mounting box (**5**) so that the pins on the back of the upper section fit into the recesses (**2**).
- Push the room thermostat onto the mounting box until it catches.

10 Electrical installation

The electrical connection may only be carried out by a suitably qualified engineer.



Danger!

Risk of fatal electric shock from touching live connections. Before working on the room thermostat, turn off the power supply and secure against restart.

10.1 Connecting the room thermostat

The thermostat is connected to the boiler via a 3-core cable. Use a cable with a cross section of at least 3 x 0.75 mm², up to 3 x 1.5 mm².

- Remove the jumper from terminals 3 and 4 on the boiler (if present).
- Connect the three-core cable to terminals 3-4-5 in the wall mounting box of the room thermostat and the electronic box of the boiler.
- Make sure you do not mix up cores 3-4-5.

Follow the instructions for the boiler.

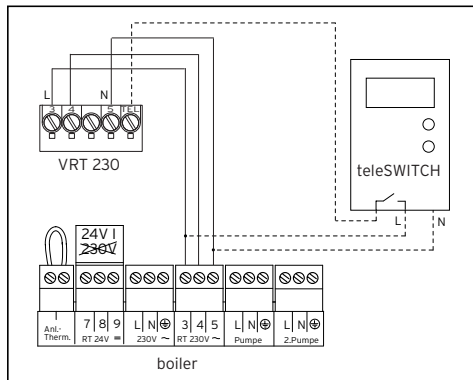

Fig. 10.1 Electrical connection

10.2 Connecting the teleSWITCH (if available)

- Connect the teleSWITCH as shown in fig. 10.1. Follow the instructions for the teleSWITCH.

11 Start-up

Some system parameters have to be set in order for them to best suit the actual conditions. These system parameters are all together in the installer level and should only be set by the heating engineer.

The service/diagnostic level is also intended for the engineer and is designed to help during servicing.

11.1 Installer level

Press the P button to access the installer level.

- Press the P button for 10 seconds. The spanner symbol and the first parameter appear in the display.
- Press the dial. You can select all the system parameters in turn.
- Turn the dial to set the values you want.

When you press the P button the display returns to basic mode.

You can select and change the following parameters:

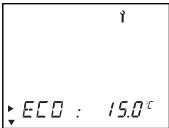
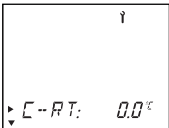
Display	Set by turning the dial
	Set-back temperature Default setting: 15 °C Adjustment range: 5 ... 30 °C
	Correction of actual room temperature Adjustment of the displayed value by up to +/- 3 °C Default setting: 0 °C

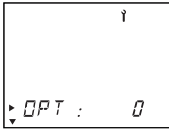
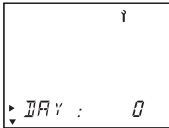
Display	Set by turning the dial
	Control characteristics/ route adjustment For optimum adaptation to the room size or radiator configuration Default setting: 0 Adjustment range: -5 ... +5 (Positive values: room thermostat switches more slowly; negative values: room thermostat switches more quickly)
	Day setting For activation of the calendar



Display	Set by turning the dial
	Month setting For activation of the calendar
	Year setting For activation of the calendar

Table 11.1 System parameters

11.2 Service/diagnostic level

Access the service/diagnostic level by pressing the P button and the dial.

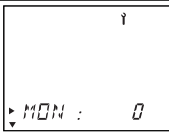
- Press the P button and the dial simultaneously for 3 seconds.

First, a heating request is triggered, to test the connection between the boiler and the switch relay.

Then you can select all the test options by pressing the dial. When you press the P button the display returns to basic mode.

You can select the following tests:

Dial	Test	Test procedure
Press and push P button 3 seconds.	Heating request	Relay switches to heating request (display: CH ON)
Turn	teleSWITCH input	Display teleSWITCH input status
Press	Display test	All display elements are displayed.
Press	Software version	The software version is displayed.

Table 11.2 Service/diagnostic level

Restoring the default settings

- To restore the room thermostat to its default condition, press the P button for 15 seconds. As soon as the display lights up twice, the room thermostat has been reset. This means that you

will have to perform all individual settings again.

11.3 Handing over to the owner

The owner of the room thermostat must be instructed about its functions and how to operate it.

- Hand over any instructions intended for the owner as well as the room thermostat documents.
- Go through the operating manual with the owner and answer any questions.
- Draw special attention to the safety instructions which the owner must follow.
- Tell the owner to keep the instruction manuals near the room thermostat.

12 Technical data

Description	Unit	
Operating voltage U_{\max}	V	230~
Maximum ambient temperature	°C	50
Power consumption	VA	1
Minimum cross-section of wires	mm ²	0.75
Level of protection		IP 20
Protection class		II
TEL active input	V	230~
Dimensions		
Height	mm	97
Width	mm	146
Depth	mm	34

Table 12.1 Technical data

13 Vaillant customer service

To ensure regular servicing, it is strongly recommended that arrangements are made for a Maintenance Agreement. Please contact Vaillant service (0870 6060 777) for further details.

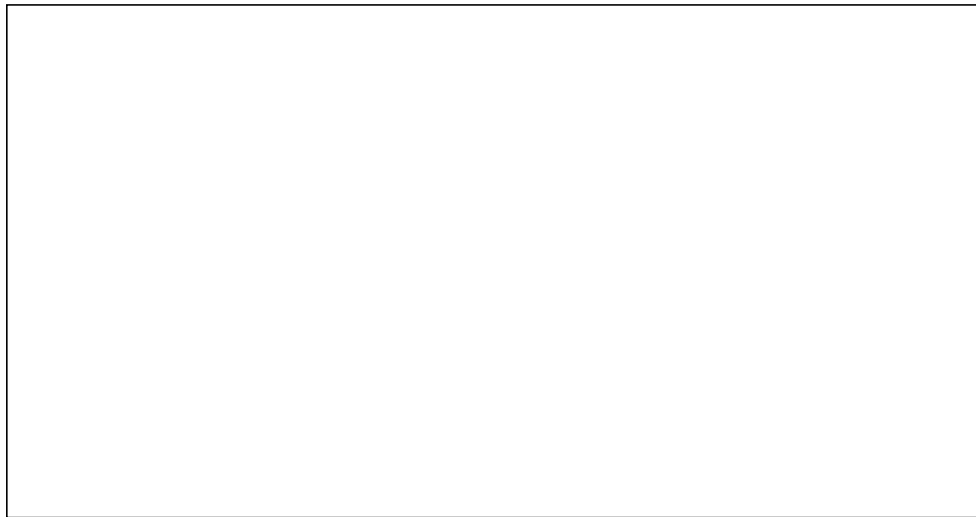

Vaillant Ltd

Vaillant House ■ Medway City Estate ■ Trident Close ■ Rochester ■ Kent ME2 4EZ
Telephone 01634 292300 ■ Fax 01634 290166 ■ www.vaillant.co.uk ■ info@vaillant.co.uk

838430_00 GB 04 2005