

TEMPERATURE TABLE			
Factors for differences between mean water temperature and room temperature in °C and °F other than 50°C (90°F)			
°C		°F	
5°C	0.050	10°F	0.057
10°C	0.123	20°F	0.142
15°C	0.209	30°F	0.240
20°C	0.304	40°F	0.348
25°C	0.406	50°F	0.466
30°C	0.515	60°F	0.590
35°C	0.629	70°F	0.721
40°C	0.748	80°F	0.858
45°C	0.872	90°F	1.000
50°C	1.000	100°F	1.147
55°C	1.132	110°F	1.298
60°C	1.267	120°F	1.454
65°C	1.406	130°F	1.613
70°C	1.549	140°F	1.776
75°C	1.694		

## GENERAL

The Stelrad Concord Plane and Lo-line radiators consist of flat oval precision tubes, pressure welded with a four mm air gap to symmetric water channels. The shapes of the flat oval tubes and water channels preclude any risk of physical injury. The same precision tubes are used on the vertical and slimline models, however the creative use of the tubes to display the slim face on the slimline model offers additional visual appeal.

## CONNECTIONS

2 x 15mm connections BOE are fitted as standard. 4 x 15mm connections are available as an optional extra, prices available on request.

## TESTING AND OPERATING PRESSURES

All models are high pressure tested to 6 bar with a maximum working pressure of 4.6 bar.

## MATERIALS USED

Flat oval steel tubes 70mm x 8mm. Water channel tubing 37mm x 32mm.

## WATER TREATMENT

On completion of the installation the system should be properly flushed and fitted in accordance with the British Code of Practice for the Treatment of Water in Domestic Hot Water Central Heating Systems BS 7593.

## COLOURS

The Stelrad Concord range colour is standard in RAL 9016 pure white. All models are available in a choice of 34 RAL colours and 5 metallic colours to special order.

## WARRANTY

As a measure of the all round dependable quality and performance the Stelrad Concord range comes complete with a 5 year Manufacturer's Warranty.

## ACCESSORIES



ADJUSTABLE FOOT



OPTIONAL EXTENSION PIECES FOR EASY REPLACEMENT



OPTIONAL 3/4 INCH VALVE ADAPTOR FOR CONNECTION WITHOUT PERFORMANCE REDUCTION.



PO Box 103,  
National Avenue,  
Hull HU5 4JN  
Tel: 0870 849 8056  
Fax: 0870 849 8058  
[www.stelrad.com](http://www.stelrad.com)



# CONCORD RANGE

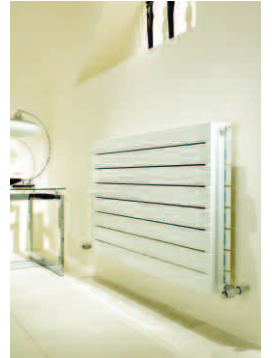

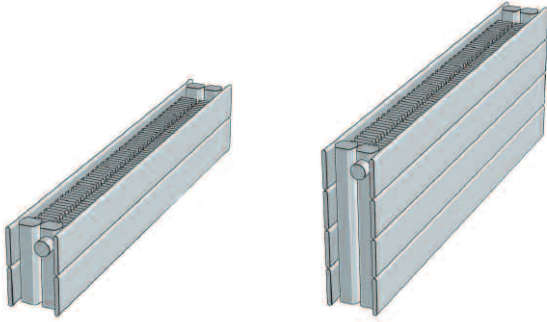

## CONCORD LO-LINE

Outputs at operating temperature 75/65/20°C according to EN442

Height	Width	Depth	Elements	Element Width	Colour RAL	Tap Centres	Tap Centres From Wall	Maximum Projection	Btu Dt 50	Watt Dt 50	Dry Weight kg	Water Content	Water Flow Ltrs/hr
144	800	92	2	70	9016	812	94	119	1809	530	10.1	1.42	44.8
144	1000	92	2	70	9016	1012	94	119	2263	663	12.57	1.77	56
144	1200	92	2	70	9016	1212	94	119	2717	796	15.1	2.12	67.2
144	1400	92	2	70	9016	1412	94	119	3167	928	17.59	2.47	78.4
144	1600	92	2	70	9016	1612	94	119	3621	1061	20.11	2.83	89.6
144	1800	92	2	70	9016	1812	94	119	4071	1193	22.62	3.18	102.6
144	2000	92	2	70	9016	2012	94	119	4525	1326	25.14	3.54	112
144	2200	92	2	70	9016	2212	94	119	4979	1459	27.65	3.89	125.4
292	800	92	4	70	9016	812	94	119	3065	898	20.04	2.86	77.6
292	1000	92	4	70	9016	1012	94	119	3829	1122	25.05	3.57	97
292	1200	92	4	70	9016	1212	94	119	4594	1346	30.06	4.28	116.4
292	1400	92	4	70	9016	1412	94	119	5362	1571	35.07	4.99	135.8
292	1600	92	4	70	9016	1612	94	119	6126	1795	40.08	5.71	155.2
292	1800	92	4	70	9016	1812	94	119	6894	2020	45.09	6.42	176.4
292	2000	92	4	70	9016	2012	94	119	7658	2244	50.1	7.14	194
292	2200	92	4	70	9016	2212	94	119	8423	2468	55.11	7.85	213.4

### FIXING POSITIONS

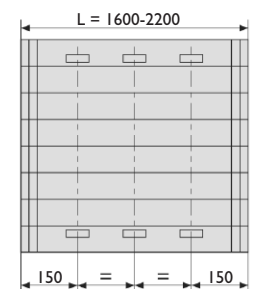
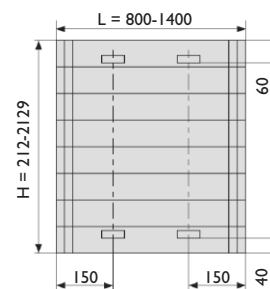
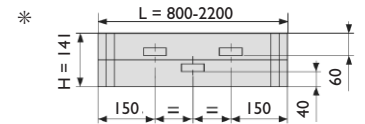
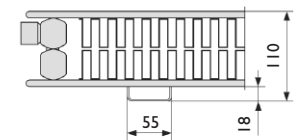
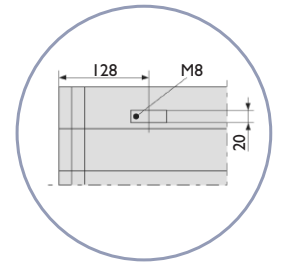

\*Welded-on foot supports recommended



CONCORD SLIMLINE

## COLOURS



CONCORD PLANE

RAL 7035		RAL 1004		RAL 6020		RAL 9001	
RAL 7038		RAL 2008		RAL 6012		RAL 1013	
RAL 7036		RAL 3017		RAL 6005		RAL 1015	
RAL 7030		RAL 3000		RAL 5014		RAL 9002	
RAL 7037		RAL 3003		RAL 5022		<b>Metallics</b>	
RAL 7015		RAL 3005		RAL 5024		BR 0002	
RAL 9005		RAL 6027		RAL 5002		BR 0004	
RAL 8017		RAL 6034		RAL 5010		BR 0006	
RAL 1016		RAL 6019		RAL 9016		BR 0007	
RAL 1021		RAL 6033		RAL 9010		Chrome	

The colours shown above are reproduced as accurately as this printing process will allow and are available to special order only on these models. Specials are subject to a 50% restock fee if returned

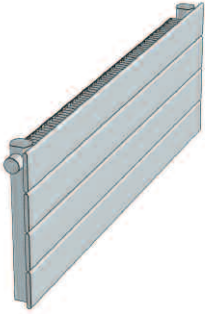

## CONCORD PLANE SINGLE

Outputs at operating temperature 75/65/20°C according to EN442

Height	Width	Depth	Elements	Element Width	Colour RAL	Tap Centres	Tap Centres From Wall	Maximum Projection	Btu Dt 50	Watt Dt 50	Dry Weight kg	Water Content	Water Flow Ltrs/hr
440	500	60	6	70	9016	512	44	70	1304	382	9.12	1.34	34
440	600	60	6	70	9016	612	44	70	1563	458	10.93	1.6	40.8
440	700	60	6	70	9016	712	44	70	1826	535	12.76	1.88	47.6
440	800	60	6	70	9016	812	44	70	2085	611	14.58	2.14	54.4
440	900	60	6	70	9016	912	44	70	2348	688	16.41	2.41	61.2
440	1000	60	6	70	9016	1012	44	70	2607	764	18.23	2.68	68
440	1100	60	6	70	9016	1112	44	70	2867	840	20.05	2.95	74.8
440	1200	60	6	70	9016	1212	44	70	3130	917	21.88	3.22	81.6
440	1400	60	6	70	9016	1412	44	70	3652	1070	25.52	3.75	95.2
440	1600	60	6	70	9016	1612	44	70	4170	1222	29.17	4.29	108.8
440	1800	60	6	70	9016	1812	44	70	4693	1375	32.81	4.82	122.4
440	2000	60	6	70	9016	2012	44	70	5215	1528	36.46	5.36	136
440	2200	60	6	70	9016	2212	44	70	5737	1681	40.11	5.9	149.6
440	2400	60	6	70	9016	2412	44	70	6259	1834	43.75	6.42	163.2
440	2600	60	6	70	9016	2612	44	70	6778	1986	47.4	6.97	176.8
440	2800	60	6	70	9016	2812	44	70	7300	2139	51.04	7.5	190.4
440	3000	60	6	70	9016	3012	44	70	7822	2292	54.96	8.04	204
588	500	60	8	70	9016	512	44	70	1706	500	12.51	1.77	40.5
588	600	60	8	70	9016	612	44	70	2044	599	15	2.12	48.6
588	700	60	8	70	9016	712	44	70	2386	699	17.51	2.48	56.7
588	800	60	8	70	9016	812	44	70	2727	799	20	2.83	64.8
588	900	60	8	70	9016	912	44	70	3068	899	22.51	3.19	72.9
588	1000	60	8	70	9016	1012	44	70	3409	999	25.01	3.54	81
588	1100	60	8	70	9016	1112	44	70	3751	1099	27.51	3.89	89.1
588	1200	60	8	70	9016	1212	44	70	4092	1199	30.01	4.25	97.2
588	1400	60	8	70	9016	1412	44	70	4775	1399	35.01	4.96	113.4
588	1600	60	8	70	9016	1612	44	70	5454	1598	40.02	5.66	129.6
588	1800	60	8	70	9016	1812	44	70	6136	1798	45.02	6.37	145.8
588	2000	60	8	70	9016	2012	44	70	6819	1998	50.02	7.08	162
588	2200	60	8	70	9016	2212	44	70	7501	2198	55.02	7.79	178.2
588	2400	60	8	70	9016	2412	44	70	8184	2398	60.02	8.5	194.4
588	2600	60	8	70	9016	2612	44	70	8863	2597	65.03	9.2	210.6
588	2800	60	8	70	9016	2812	44	70	9546	2797	70.03	9.91	226.8
588	3000	60	8	70	9016	3012	44	70	10228	2997	75.03	10.62	243
736	500	60	10	70	9016	512	44	70	2068	606	15.99	2.22	49.5
736	600	60	10	70	9016	612	44	70	2481	727	19.19	2.66	59.4
736	700	60	10	70	9016	712	44	70	2894	848	22.39	3.10	69.3
736	800	60	10	70	9016	812	44	70	3310	970	25.58	3.54	79.2
736	900	60	10	70	9016	912	44	70	3723	1091	28.78	3.99	89.1
736	1000	60	10	70	9016	1012	44	70	4136	1212	31.98	4.43	99
736	1100	60	10	70	9016	1112	44	70	4549	1333	35.18	4.87	108.9
736	1200	60	10	70	9016	1212	44	70	4962	1454	38.38	5.32	118.8
736	1400	60	10	70	9016	1412	44	70	5792	1697	44.77	6.20	138.6
736	1600	60	10	70	9016	1612	44	70	6617	1939	51.17	7.09	158.4
736	1800	60	10	70	9016	1812	44	70	7447	2182	57.56	7.97	178.2
736	2000	60	10	70	9016	2012	44	70	8273	2424	63.96	8.86	198
736	2200	60	10	70	9016	2212	44	70	9099	2666	70.36	9.75	217.8
736	2400	60	10	70	9016	2412	44	70	9928	2909	76.75	10.63	237.6
736	2600	60	10	70	9016	2612	44	70	10754	3151	83.15	11.52	257.4
736	2800	60	10	70	9016	2812	44	70	11583	3394	89.54	12.40	277.2
736	3000	60	10	70	9016	3012	44	70	12409	3636	95.94	13.29	297

### FIXING POSITIONS

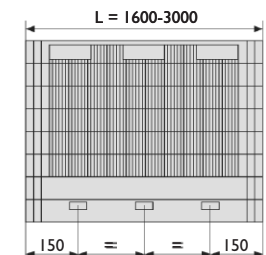
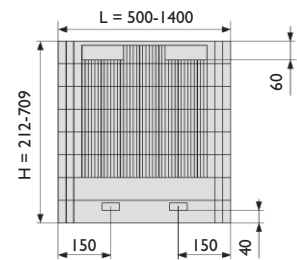
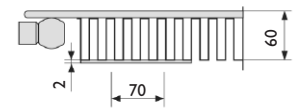
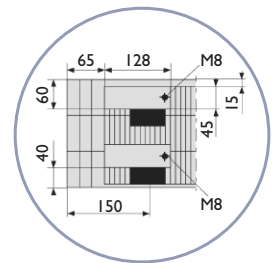

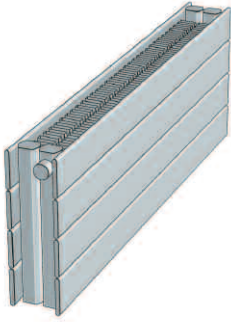

# CONCORD PLANE DOUBLE

Outputs at operating temperature 75/65/20°C according to EN442

Height	Width	Depth	Elements	Element Width	Colour RAL	Tap Centres	Tap Centres From Wall	Maximum Projection	Btu Dt 50	Watt Dt 50	Dry Weight kg	Water Content	Water Flow Ltrs/hr
440	500	92	6	70	9016	512	94	119	2297	673	16.40	2.66	54.5
440	600	92	6	70	9016	612	94	119	2758	808	19.67	3.19	65.4
440	700	92	6	70	9016	712	94	119	3215	942	22.95	3.72	76.3
440	800	92	6	70	9016	812	94	119	3676	1077	26.23	4.25	87.2
440	900	92	6	70	9016	912	94	119	4133	1211	29.51	4.78	98.1
440	1000	92	6	70	9016	1012	94	119	4594	1346	32.79	5.31	109
440	1100	92	6	70	9016	1112	94	119	5054	1481	36.07	5.84	119.9
440	1200	92	6	70	9016	1212	94	119	5512	1615	39.35	6.37	130.8
440	1400	92	6	70	9016	1412	94	119	6430	1884	45.91	7.43	152.6
440	1600	92	6	70	9016	1612	94	119	7351	2154	52.46	8.50	174.4
440	1800	92	6	70	9016	1812	94	119	8269	2423	59.02	9.56	196.2
440	2000	92	6	70	9016	2012	94	119	9187	2692	65.58	10.62	218
440	2200	92	6	70	9016	2212	94	119	10105	2961	72.14	11.68	239.8
440	2400	92	6	70	9016	2412	94	119	11023	3230	78.70	12.74	261.6
440	2600	92	6	70	9016	2612	94	119	11945	3500	85.25	13.81	283.4
440	2800	92	6	70	9016	2812	94	119	12863	3769	91.81	14.87	305.2
440	3000	92	6	70	9016	3012	94	119	13781	4038	98.37	15.93	327
588	500	92	6	70	9016	512	94	119	2822	827	22.51	3.55	70
588	600	92	8	70	9016	612	94	119	3385	992	27.01	4.25	84
588	700	92	8	70	9016	712	94	119	3952	1158	31.51	4.96	98
588	800	92	8	70	9016	812	94	119	4515	1323	36.01	5.67	112
588	900	92	8	70	9016	912	94	119	5082	1489	40.51	6.38	126
588	1000	92	8	70	9016	1012	94	119	5645	1654	45.01	7.09	140
588	1100	92	8	70	9016	1112	94	119	6208	1819	49.51	7.80	154
588	1200	92	8	70	9016	1212	94	119	6774	1985	54.01	8.51	168
588	1400	92	8	70	9016	1412	94	119	7904	2316	63.01	9.93	196
588	1600	92	8	70	9016	1612	94	119	9030	2646	72.02	11.34	224
588	1800	92	8	70	9016	1812	94	119	10160	2977	81.02	12.76	252
588	2000	92	8	70	9016	2012	94	119	11290	3308	90.02	14.18	280
588	2200	92	8	70	9016	2212	94	119	12419	3639	99.02	15.60	308
588	2400	92	8	70	9016	2412	94	119	13549	3970	108.02	17.02	336
588	2600	92	8	70	9016	2612	94	119	14675	4300	117.03	18.43	364
588	2800	92	8	70	9016	2812	94	119	15805	4631	126.03	19.85	392
588	3000	92	8	70	9016	3012	94	119	16934	4962	135.03	21.27	420
736	500	92	10	70	9016	512	94	119	3570	1046	28.72	4.43	83.00
736	600	92	10	70	9016	612	94	119	4283	1255	34.46	5.32	99.60
736	700	92	10	70	9016	712	94	119	4996	1464	40.21	6.20	116.20
736	800	92	10	70	9016	812	94	119	5713	1674	45.95	7.09	132.80
736	900	92	10	70	9016	912	94	119	6426	1883	51.70	7.97	149.40
736	1000	92	10	70	9016	1012	94	119	7140	2092	57.44	8.86	166.00
736	1100	92	10	70	9016	1112	94	119	7853	2301	63.18	9.75	182.60
736	1200	92	10	70	9016	1212	94	119	8566	2510	68.93	10.63	199.20
736	1400	92	10	70	9016	1412	94	119	9996	2929	80.42	12.40	232.40
736	1600	92	10	70	9016	1612	94	119	11423	3347	91.90	14.18	265.60
736	1800	92	10	70	9016	1812	94	119	12853	3766	103.39	15.95	298.80
736	2000	92	10	70	9016	2012	94	119	14279	4184	114.88	17.72	332.00
736	2200	92	10	70	9016	2212	94	119	15706	4602	126.37	19.49	365.20
736	2400	92	10	70	9016	2412	94	119	17136	5021	137.86	21.26	398.40
736	2600	92	10	70	9016	2612	94	119	18562	5439	149.34	23.04	431.60
736	2800	92	10	70	9016	2812	94	119	19992	5858	160.83	24.81	464.80
736	3000	92	10	70	9016	3012	94	119	21419	6276	172.32	26.58	498.00

## FIXING POSITIONS

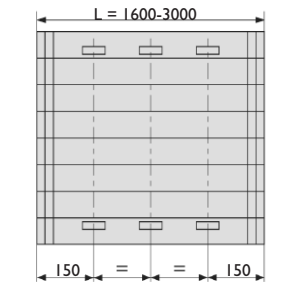
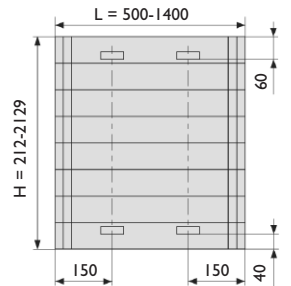
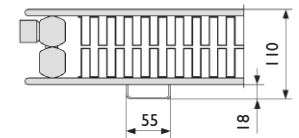
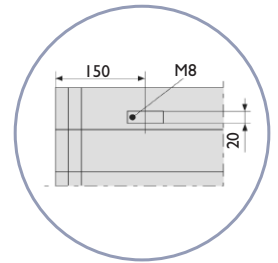

Offering visual appeal combined with advanced technology, the Concord range of radiators provides a contemporary solution to a wide range of building applications. With a choice of four different types of radiator and a variety of sizes and outputs, Concord allows extensive flexibility of siting whilst breaking new barriers in heating efficiency.



# ELEGANT STYLING & TOTAL FLEXIBILITY

## CONCORD PLANE

Constructed from slim flat tubes that lie horizontally, the Concord Plane offers a new vision for radiators. Available in 3 different heights with widths from 500mm to 3000mm, 102 models with outputs from 1304 Btu/382 watts to 21,419 Btu/6276 watts.



## CONCORD LO-LINE

With only two panels this Lo-line model is a derivative of the standard, but offers efficiency of performance that belies its size. 16 models with 2 height and 8 width options and outputs from 1809 Btu/530 watts to 8423 Btu/2468 watts.

## CONCORD SLIMLINE

With all the benefits of the vertical model, the Concord Slimline offers a subtle visual appeal by displaying the slim form of the tubes. A choice of 8 models with 2 height and 4 width options and outputs from 2976 Btu/872 watts to 6675 Btu/1956 watts.

## CONCORD VERTICAL

This resourceful alternative takes the same highly engineered tubes and turns technology on its head to provide a vertical model. A choice of 6 models with 2 height and 3 width options and outputs from 2662 Btu/780 watts to 4949 Btu/1450 watts.

Whatever your building specification you can be sure that this advanced range of space heaters will provide the elegant visual style, combined with top quality engineering and performance.



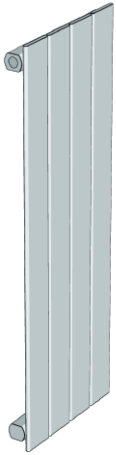

# CONCORD VERTICAL

Outputs at operating temperature 75/65/20°C according to EN442

Height	Width	Depth	Elements	Element Width	Colour RAL	Tap Centres	Tap Centres From Wall	Maximum Projection	Btu Dt 50	Watt Dt 50	Dry Weight kg	Water Content	Water Flow Ltrs/hr
1800	440	45	6	70	9016	440	44	70	2662	780	19.86	4.26	66
1800	588	45	8	70	9016	588	44	70	3549	1040	26.48	5.68	88
1800	736	45	10	70	9016	736	44	70	4437	1300	33.1	7.1	110
2000	440	45	6	70	9016	440	44	70	2969	870	21.9	4.68	72
2000	588	45	8	70	9016	588	44	70	3959	1160	29.2	6.24	96
2000	736	45	10	70	9016	736	44	70	4949	1450	36.5	7.8	120

## FIXING POSITIONS

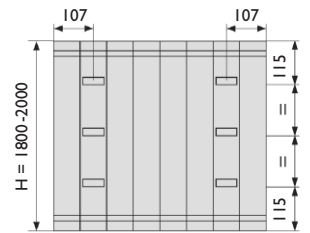
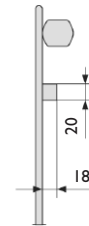
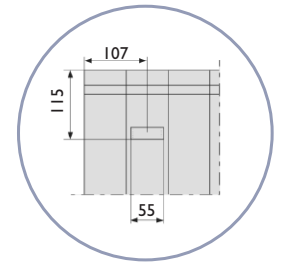

## MOUNTING BRACKET INFORMATION

- CONCORD PLANE SINGLE
- CONCORD PLANE DOUBLE
- CONCORD LO-LINE
- CONCORD VERTICAL

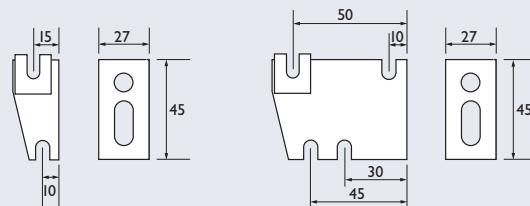

Type	From back of radiator to wall D	From wall to centre of connections D1	From front of radiator to wall D
Plane Single	9	44	69
Plane Double	27	94	119
Vertical	25	44	70



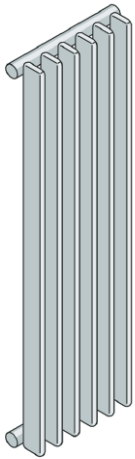

# CONCORD SLIMLINE

Outputs at operating temperature 75/65/20°C according to EN442

Height	Width	Depth	Elements	Element Width	Colour RAL	Tap Centres	Tap Centres From Wall	Maximum Projection	Btu Dc 50	Watt Dc 50	Dry Weight kg	Water Content	Water Flow Ltrs/hr
1800	320	95	8	40	9016	320	50	130	2976	872	24.9	5.6	74.96
1800	440	95	11	40	9016	440	50	130	4092	1199	34.23	7.7	103.1
1800	520	95	13	40	9016	520	50	130	4836	1417	40.47	9.1	121.8
1800	640	95	16	40	9016	640	50	130	5952	1744	49.81	11.2	112
2000	320	95	8	40	9016	320	50	130	3338	978	25.12	6.16	83.8
2000	440	95	11	40	9016	440	50	130	4587	1344	34.54	8.47	115.4
2000	520	95	13	40	9016	520	50	130	5423	1589	40.82	10.01	136.4
2000	640	95	16	40	9016	640	50	130	6675	1956	50.24	12.32	167.8

## FIXING POSITIONS

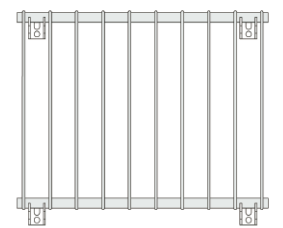
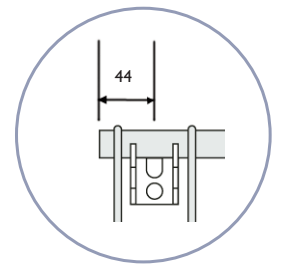

## MOUNTING BRACKET INFORMATION

CONCORD SLIMLINE

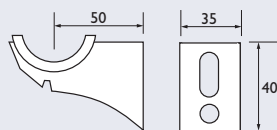

Type	Back face to finished wall D	Connection centres from finished wall D1	Front face from finished wall D2
Slimline	35	50	130

