

# User Guide and Important Warranty Information

# Suprima HE Range

Condensing  
Central Heating  
Boiler

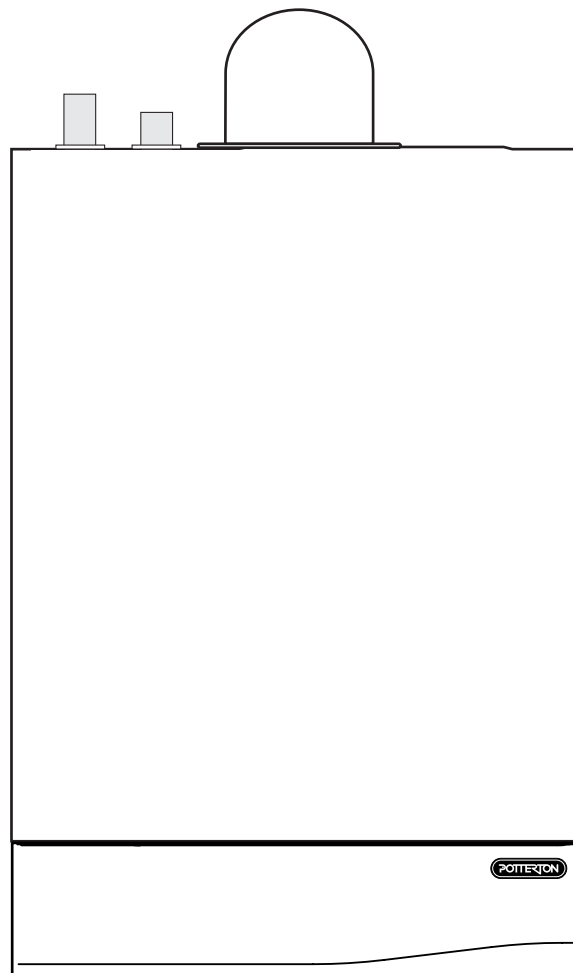

# POTTERTON

Please keep these instructions in a safe place.  
If you move house, please hand them over to the next occupier

Section	Page
1.0 Quick Reference Guide	3
2.0 Troubleshooting	4
3.0 Clearances/Care of the Boiler	6
4.0 Legislation	7
5.0 Warranty & Service	8

## Natural Gas

- Potterton Suprima 30 HE  
G.C.N° 41 075 35
- Potterton Suprima 40 HE  
G.C.N° 41 075 36
- Potterton Suprima 50 HE  
G.C.N° 41 075 37
- Potterton Suprima 60 HE  
G.C.N° 41 075 38
- Potterton Suprima 70 HE  
G.C.N° 41 075 39
- Potterton Suprima 80 HE  
G.C.N° 41 075 40

### The Benchmark Scheme

Baxi Heating UK Ltd is a licensed member of the Benchmark Scheme which aims to improve the standards of installation and commissioning of domestic heating and hot water systems in the UK and to encourage regular servicing to optimise safety, efficiency and performance.

Benchmark is managed and promoted by the Heating and Hotwater Industry Council. For more information visit [www.centralheating.co.uk](http://www.centralheating.co.uk)

© Baxi Heating UK Ltd 2010 All rights reserved. No part of this publication may be reproduced or transmitted in any form or by any means, or stored in any retrieval system of any nature (including in any database), in each case whether electronic, mechanical, recording or otherwise, without the prior written permission of the copyright owner, except for permitted fair dealing under Copyrights, Designs and Patents Act 1988.

Applications for the copyright owner's permission to reproduce or make other use of any part of this publication should be made, giving details of the proposed use, to the following address:

The Company Secretary, Baxi Heating UK Ltd, The Wyvern Business Park, Stanier Way, Derby, DE21 6BF.

Full acknowledgement of author and source must be given.

**WARNING:** Any person who does any unauthorised act in relation to a copyright work may be liable to criminal prosecution and civil claims for damages.

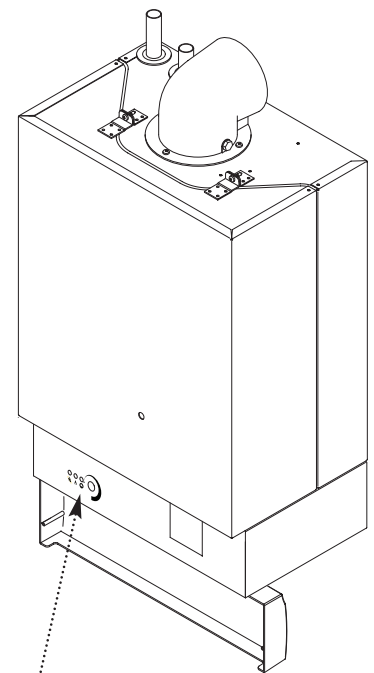





Boiler Controls - see opposite page for Operating Quick Reference Guide



ISO 9001  
FM 00866

# Key to Controls

	<b>Lockout</b> (Red Light)	If Lockout Light is ON or flashing the boiler will need resetting. If Lockout occurs persistently consult your Installer or Service Engineer.
	<b>Burner On</b> (Green Light)	This indicates that the Burner has fired up and is heating your system.
	<b>Mains On</b> (Green Light)	This indicates that there is electricity to the Boiler.
	<b>Boiler Temperature Control Knob</b>	Turn the Boiler Temperature Control Knob clockwise to increase or anticlockwise to decrease the temperature.

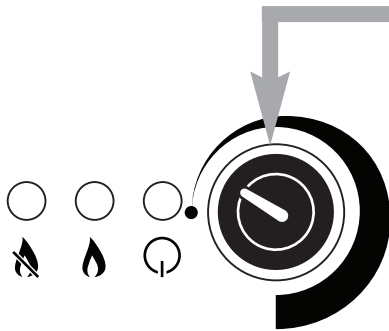

### Boiler Temperature Control

Turn the Boiler Temperature Control Knob clockwise to increase or anticlockwise to decrease the temperature.

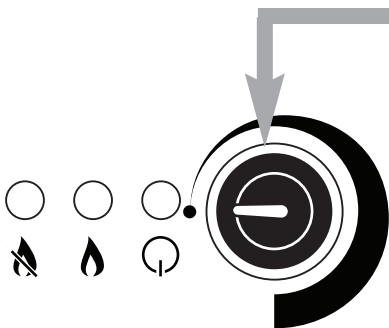

### Resetting the Boiler

If the Red Lockout Light (  ) is ON or FLASHING, turn the temperature control knob to the off (•) position and when the lockout light goes off, turn control knob back to required setting, the boiler will fire up and return to normal operation. If lockout occurs frequently a fault is indicated and you should contact your installer.

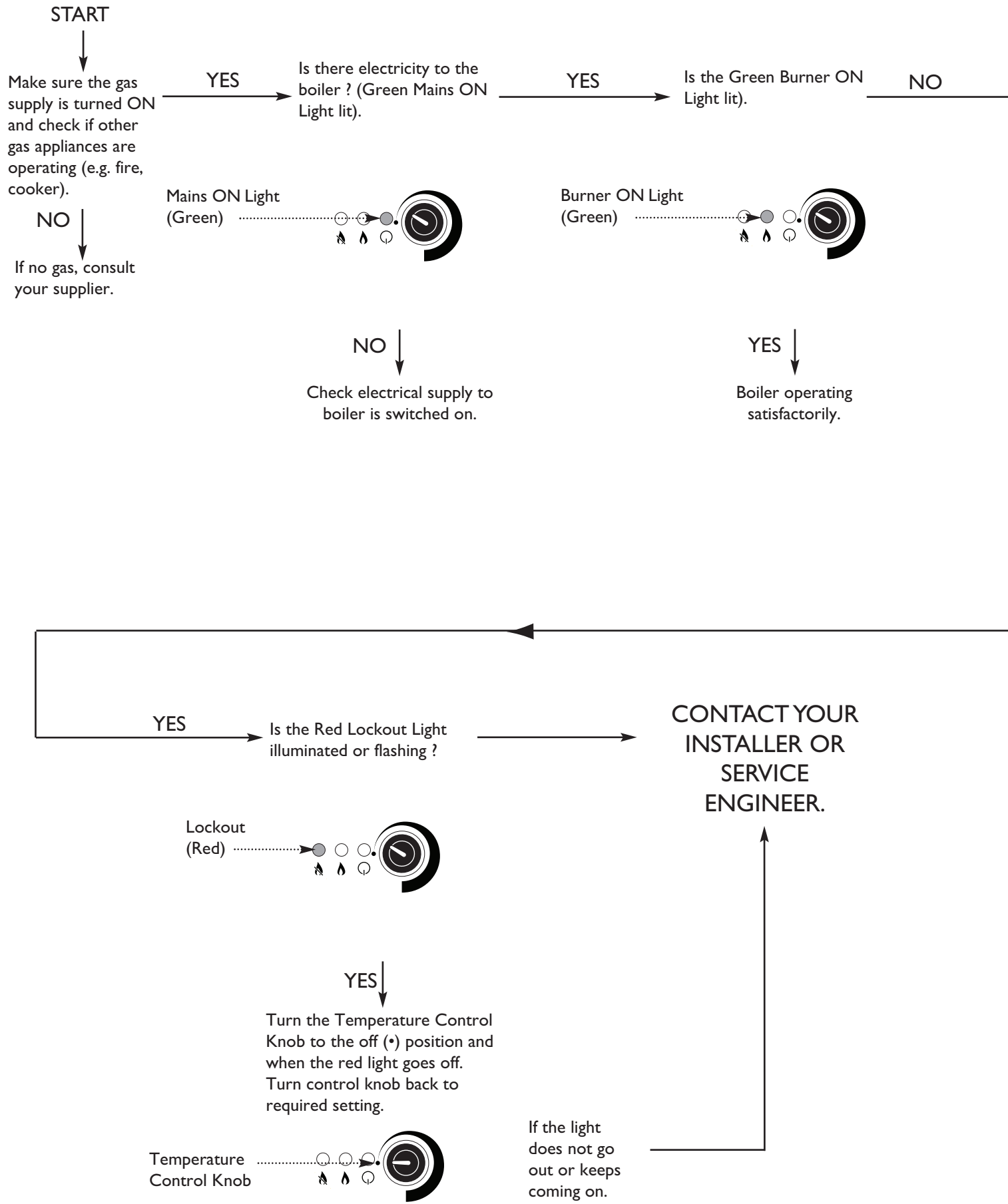

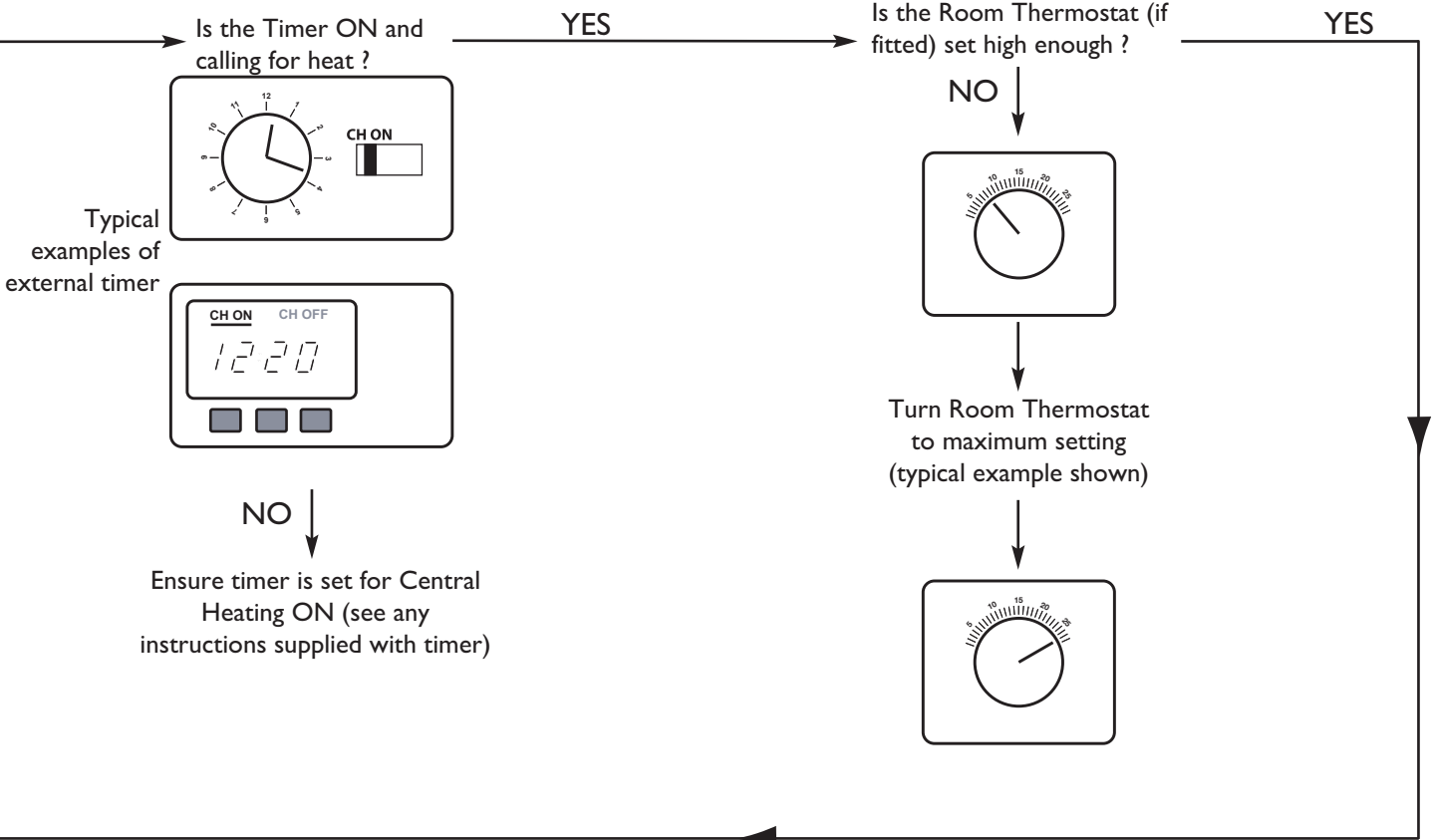

If you don't know what you need to do to get the boiler to light, or need help with the system and controls, contact your installer as soon as possible

## 3.0 Clearances/Care of the Boiler

### 3.1 For your Safety

1. This appliance must have been installed in accordance with the manufacturer's instructions and the regulations in force.
2. Any modification that may interfere with the normal operation of the appliance without express written permission from the manufacturer or his agent could invalidate the appliance warranty. In GB this could also infringe the Gas Safety (Installation and Use) Regulations.

**GB** - Heating Industry definition meaning England, Scotland, Wales, Northern Ireland, Isle of Man and the Channel Isles

3. Your boiler must not be operated without the casing correctly fitted.
4. Do not interfere with any sealed components on this boiler.
5. Take note of any warning labels on your boiler.
6. Your boiler should have the following minimum clearances for Safety and Maintenance (Figs. 1 & 2):-

Top	- 125mm
Bottom	- 130mm
Left side	- 5mm
Right Side	- 5mm
Front	- 15mm (In Operation) - 610mm (For Servicing)

7. If your boiler is installed in a compartment, do not use it for storage purposes. Do not obstruct any purpose provided ventilation openings.
8. Flammable materials must not be stored in close proximity to your boiler.
9. Avoid skin contact when your boiler is in operation, as some surfaces may get hot e.g. pipework.
10. Ensure that the flue terminal, outside the house, does not become damaged or obstructed, particularly by foliage.

11. It is important that the condensate drain system is not blocked, modified or damaged in any way as this would affect the operation of your boiler. Your installer should have insulated any exposed pipework.

### 3.2 Cleaning the Outercase

1. The painted panels should be wiped with a damp cloth and then dried completely. Do not use abrasive cleaning agents.

### 3.3 Boiler Protection

The protection systems listed below will always be working whilst the gas and electricity supplies to the boiler are on.

1. To ensure the boiler is protected during very cold conditions a frost protection feature is built in to the boiler. If the boiler temperature falls below 4°C the boiler will fire until a temperature of 15°C is reached.
2. The boiler incorporates a built in pump protection feature which continually monitors the time since the pump last operated. The pump will run for around 2 minutes if it has not run in the last 24 hours. This may occur during the night when your heating controls are set to off.
3. The boiler is fitted with a safety thermostat to protect against overheating of the water. If this thermostat operates the boiler will lockout and the 'Lockout' (Red) light will flash once a second. The boiler will require resetting before it will re-light.
4. A frost thermostat may have been fitted to your system. Your installer will have advised you of this.

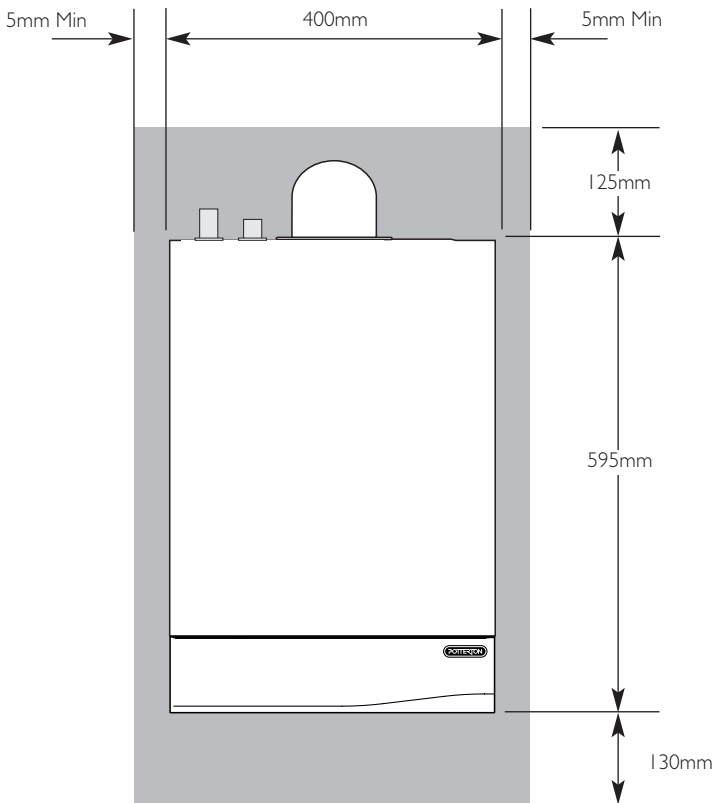

Fig. 1

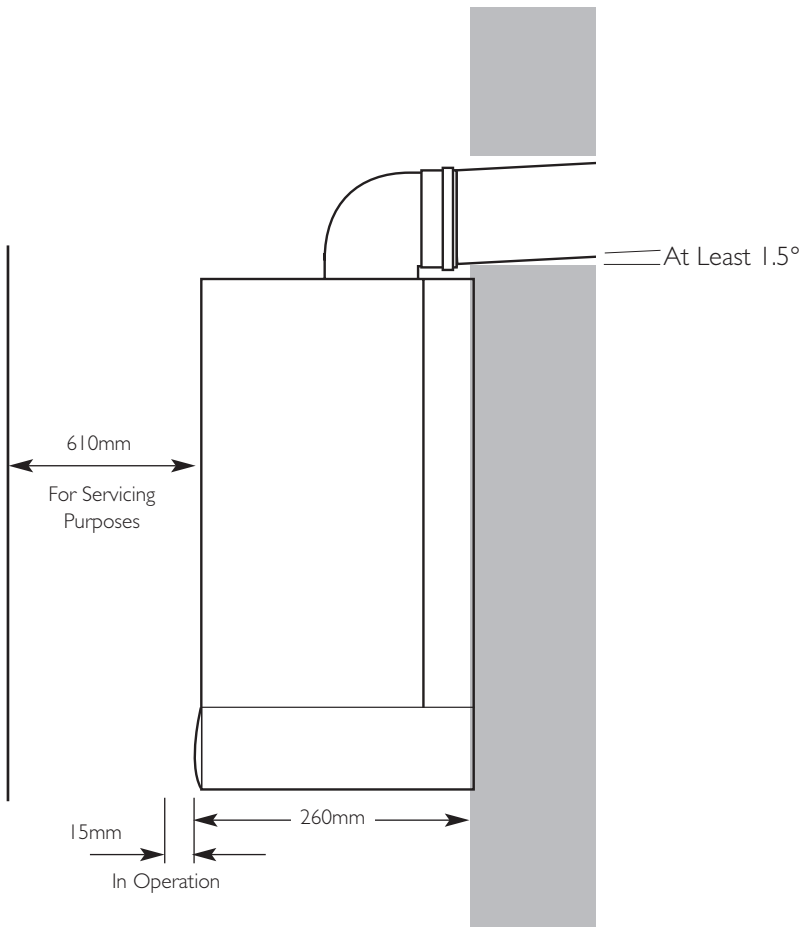

Fig. 2

## 4.0 Legislation

### 4.1 Installation, Commissioning, Service & Repair

1. This appliance must be installed in accordance with the manufacturer's instructions and the regulations in force. Read the instructions fully before installing or using the appliance.
2. In GB, this must be carried out by a competent person as stated in the Gas Safety (Installation & Use) Regulations.
3. **Definition of competence:** A person who works for a Gas Safe registered company and holding current certificates in the relevant ACS modules, is deemed competent.
4. IN IE (Eire), this must be carried out by a competent person as stated in I.S. 813 "Domestic Gas Installations".

**Lifting** - This product should be lifted and handled by two people. Stooping should be avoided and protective equipment worn where necessary. Carrying & lifting equipment should be used as required, e.g. when installing in a loft space.

All Gas Safe registered engineers carry an ID card with their licence number and a photograph. You can check your engineer is registered by telephoning 0800 408 5500 or online at [www.GasSafeRegistered.co.uk](http://www.GasSafeRegistered.co.uk)

The boiler meets the requirements of Statutory Instrument "The Boiler (Efficiency) Regulations 1993 No 3083" and is deemed to meet the requirements of Directive 92/42/EEC on the energy efficiency requirements for new hot water boilers fired with liquid or gaseous fuels:-

Type test for purpose of Regulation 5 certified by:  
Notified Body 0087.

Product/Production certified by:  
Notified Body 0086.

For GB/IE only.

### 4.2 Benchmark Commissioning Checklist

1. Please ensure that the installer has fully completed the Benchmark Checklist on the inside back pages of the installation instructions supplied with the product and that you have signed it to say that you have received a full and clear explanation of its operation. The installer is legally required to complete a commissioning checklist as a means of complying with the appropriate Building Regulations (England and Wales).
2. All installations must be notified to Local Area Building Control either directly or through a Competent Persons Scheme. A Building Regulations Compliance Certificate will then be issued to the customer who should, on receipt, write the Notification Number on the Benchmark Checklist.
3. This product should be serviced regularly to optimise its safety, efficiency and performance. The service engineer should complete the relevant Service Record on the Benchmark Checklist after each service.
4. The Benchmark Checklist may be required in the event of any warranty work and as supporting documentation relating to home improvements in the optional documents section of the Home Information Pack.

## Warning !

### If you smell gas

Do not operate light switches  
Do not operate any electrical equipment  
Do not use a telephone in the hazardous area  
Extinguish any naked flame and do not smoke  
Open windows and doors in the hazardous area  
Turn off the gas supply at the meter  
Warn any other occupants and vacate the premises  
Telephone the National Gas Emergency Service on:-  
0800 111 999

### Faulty boiler

If it is known or suspected that a fault exists on the boiler, it must not be used until the fault has been corrected by a competent person.

Please complete the boxes below

Serial Number

Date of Installation

D	D	M	M	Y	Y

Installer Details (name, address and contact number(s))

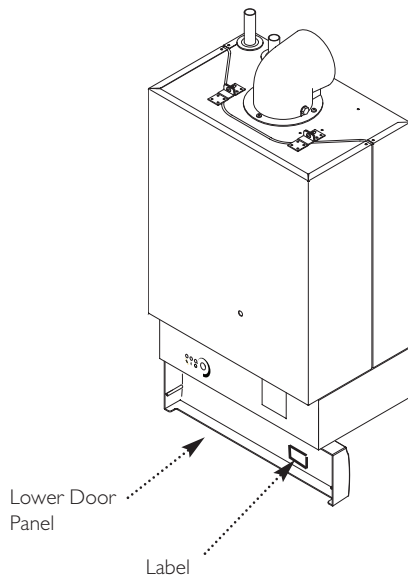

All descriptions and illustrations provided in this leaflet have been carefully prepared but we reserve the right to make changes and improvements in our products which may affect the accuracy of the information contained in this leaflet. All goods are sold subject to our standard Conditions of Sale which are available on request.

## POTTERTON

A Trading Division of Baxi Heating UK Ltd (3879156)  
A Division of Baxi Group  
Brooks House, Coventry Road, Warwick. CV34 4LL  
After Sales Service 0844 871 1560 Technical Enquiries 0844 871 1555  
Website [www.potterton.co.uk](http://www.potterton.co.uk)  
e&oe



## 5.0 Warranty & Service

### Standard Warranty Term & Conditions

#### 12 Months Free Warranty - register today

To receive your 12 months free warranty please complete the form supplied with the boiler or simply call **heateam**, the service of Baxi Heating UK Ltd on **0800 731 1644**.

#### Our promise to you

If you experience a fault with your new boiler, we aim to provide a safe and high quality repair service supported by our dedicated national network of highly skilled engineers. If your installer can't resolve the problem for you, we will do everything we can to get an engineer out to you as quickly as possible. Nothing in this warranty will affect your statutory consumer rights.

#### What you need to do if you experience a problem with your heating system or the operation of the boiler

You should always contact your installer first, because the fault may not be related to the boiler. If your installer confirms that the fault is within the boiler itself and he/she can't repair it, our friendly customer service team is on hand to help. Simply call our service division **heateam** on **0844 871 1560** to book an engineer visit or for any general advice that you may need. Our contact centre is open Monday to Friday 8am - 6pm, weekends and Bank Holidays 8.30am - 2pm, excluding Christmas Day and New Years Day.

When calling **heateam** it would be helpful if you could have the following information to hand:-

- 1 boiler serial number (see opposite).
- 2 boiler make and model number.
- 3 Your installer name and address details.
- 4 Proof of purchase (if you do not have the boiler serial number).

#### What this warranty covers

Free of charge repair or replacement of components found to be faulty from manufacture.

Free of charge replacement of the complete unit provided always that the failure is related to a manufacturing fault that cannot be repaired or is uneconomic to repair.

The warranty runs for 12 months from the date your product is installed.

#### What this warranty does not cover

Repairs to boilers which haven't been installed and commissioned properly, and as set out in the installation instructions (this includes the need to flush the system effectively and add a suitable corrosion inhibitor).

Any damage caused by hard water scale deposits and/or aggressive water resulting from corrosion.

Any other defects or failures, either in the connected heating system or outside of the boiler itself.

Faults caused by inadequate supply of electricity, gas or water to the property.

Installations within commercial settings for which this boiler was not designed.

Reimbursement of any third party repair or replacement costs that we haven't been told about or agreed with you in advance.

Compensation for consequential losses (e.g. loss of earnings, business losses, stress and inconvenience) arising from a production breakdown, including repair delays caused by factors outside our reasonable control.

#### Annual Service

To ensure you receive the maximum efficiency from your boiler we recommend your boiler has an annual service so you and your family can continue to enjoy heating and hot water comfort. To arrange an annual service from one of our Baxi Heating UK Ltd heating experts, please call Tel: 0844 871 1545.