

# User Guide and Important Warranty Information

# Promax HE Store Range

Condensing Boilers with  
Integrated Hot Water  
Storage

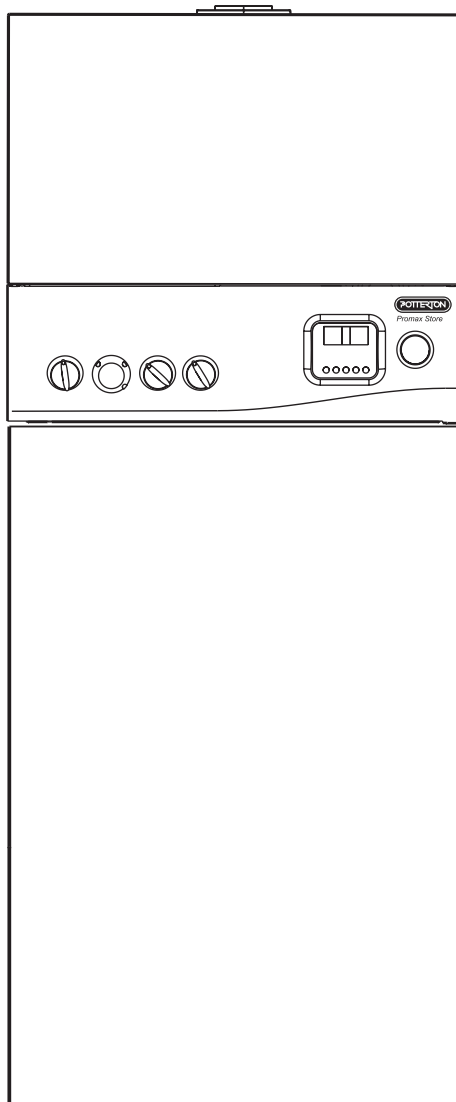

Please keep these instructions in a safe place.  
If you move house, please hand them over to the next occupier

## Natural Gas

### Potterton HE Store

G.C.N° 41 601 24 (90 litre)  
G.C.N° 41 591 76 (115 litre)  
G.C.N° 41 591 77 (150 litre)

### Advice to Users

Promax HE Store provides domestic hot water from a high performance, high efficiency version of a traditional storage cylinder. Whenever hot water is used it is replaced by fresh cold water and, provided this occurs when the programmer is in a 'DHW ON' period, the boiler will operate to raise it to the temperature you have selected. This will take from a few minutes to around 20 minutes, depending on how much hot water has been drawn from the storage cylinder. Please adjust the time and temperature settings on the programmer according to your experience of the boiler's performance and your household's need for hot water.

### The Benchmark Scheme

Baxi Heating UK Ltd is a licensed member of the Benchmark Scheme which aims to improve the standards of installation and commissioning of domestic heating and hot water systems in the UK and to encourage regular servicing to optimise safety, efficiency and performance.

Benchmark is managed and promoted by the Heating and Hotwater Industry Council. For more information visit [www.centralheating.co.uk](http://www.centralheating.co.uk)

© Baxi Heating UK Ltd 2009 All rights reserved. No part of this publication may be reproduced or transmitted in any form or by any means, or stored in any retrieval system of any nature (including in any database), in each case whether electronic, mechanical, recording or otherwise, without the prior written permission of the copyright owner, except for permitted fair dealing under Copyrights, Designs and Patents Act 1988.

Applications for the copyright owner's permission to reproduce or make other use of any part of this publication should be made, giving details of the proposed use, to the following address:

The Company Secretary, Baxi Heating UK Ltd, The Wyvern Business Park, Stanier Way, Derby, DE21 6BF.

Full acknowledgement of author and source must be given.

**WARNING:** Any person who does any unauthorised act in relation to a copyright work may be liable to criminal prosecution and civil claims for damages.

## Contents

Section	Page
1.0 Quick Reference Guide	3
2.0 Troubleshooting	4
3.0 Repressurising System	6
4.0 Clearances	7
5.0 Care of the Boiler	8
6.0 Legislation	9
7.0 Programmer	10
8.0 Notes	14
9.0 Emergency	15



ISO 9001  
FM 0086

This product has an energy rating (A) on a scale of A to G.  
For more information see [www.boilers.org.uk](http://www.boilers.org.uk). This is a certification mark.

# 1.0 Quick Reference Guide

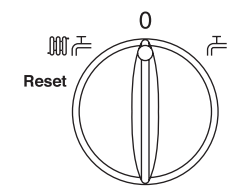
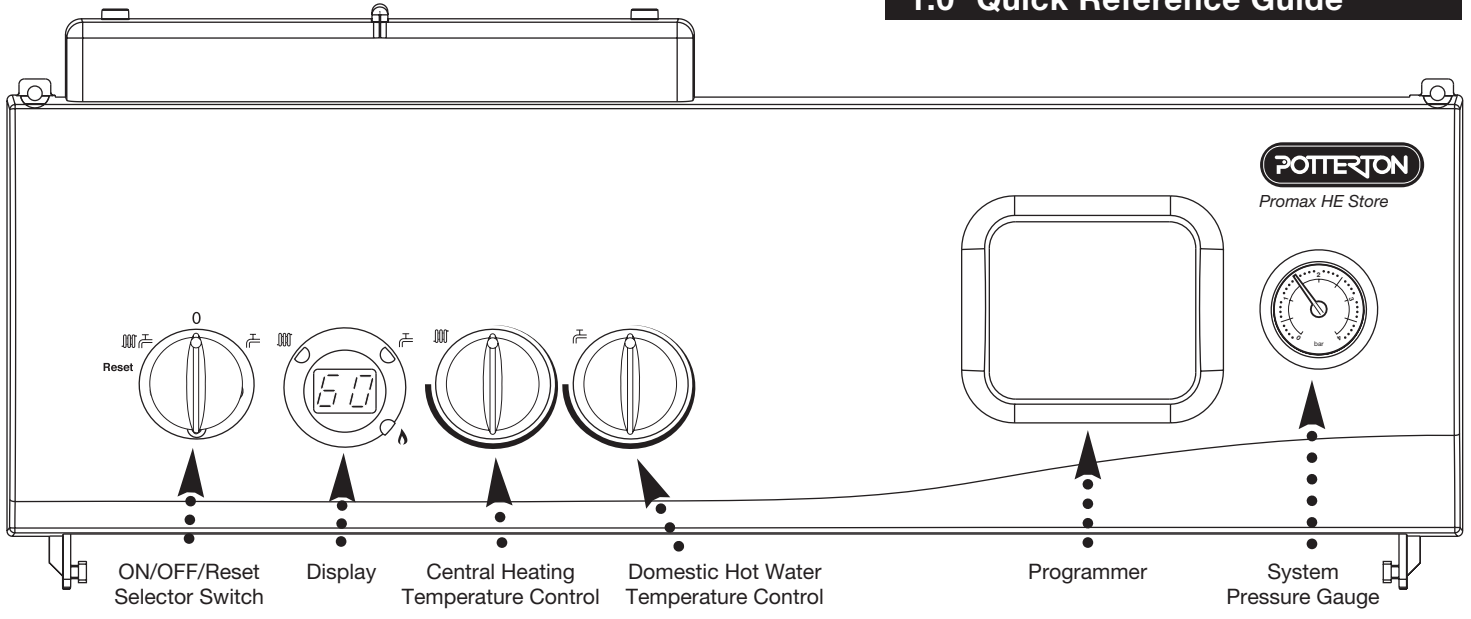

**OFF Position**  
The boiler will not operate.

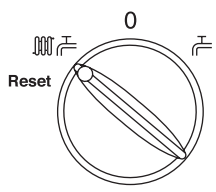

**Central Heating & Hot Water**  
Both Heating & Hot Water will operate.

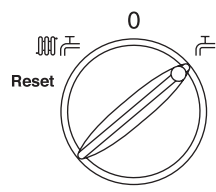

**Hot Water**  
Hot Water only will operate.

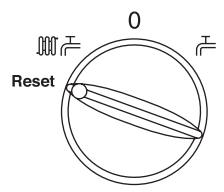

**Reset**  
Hold for approx 5 seconds and release.



**Central Heating Indicator** - The indicator will illuminate when the boiler is in the central heating mode.

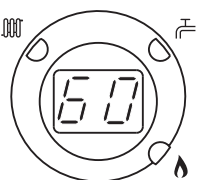

**Domestic Hot Water Indicator** - The indicator will illuminate when hot water is being supplied to a tap or shower.



**Burner On Indicator** - The indicator will illuminate when the burner has fired and is heating your central heating or domestic hot water.



**Boiler Output Temperature** - In either the central heating or domestic hot water position the display will illuminate showing the current boiler temperature in degrees centigrade.

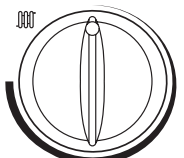

**Central Heating Temperature Control**

Turn the knob clockwise to increase or anticlockwise to decrease the temperature. Range 25° C to 80° C.

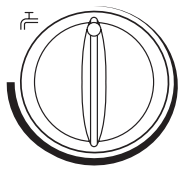

**Domestic Hot Water Temperature Control**

Turn the knob clockwise to increase or anticlockwise to decrease the temperature. Range approximately 45° C to 65° C.

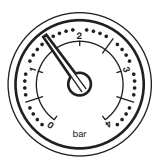

**Central Heating System Pressure** - The normal operating water pressure is between 1 and 2.0 bar. If the pressure exceeds 3 bar the safety pressure valve will operate and a fault is indicated. Contact your Installer.

# Boiler not working

## 2.0 Troubleshooting

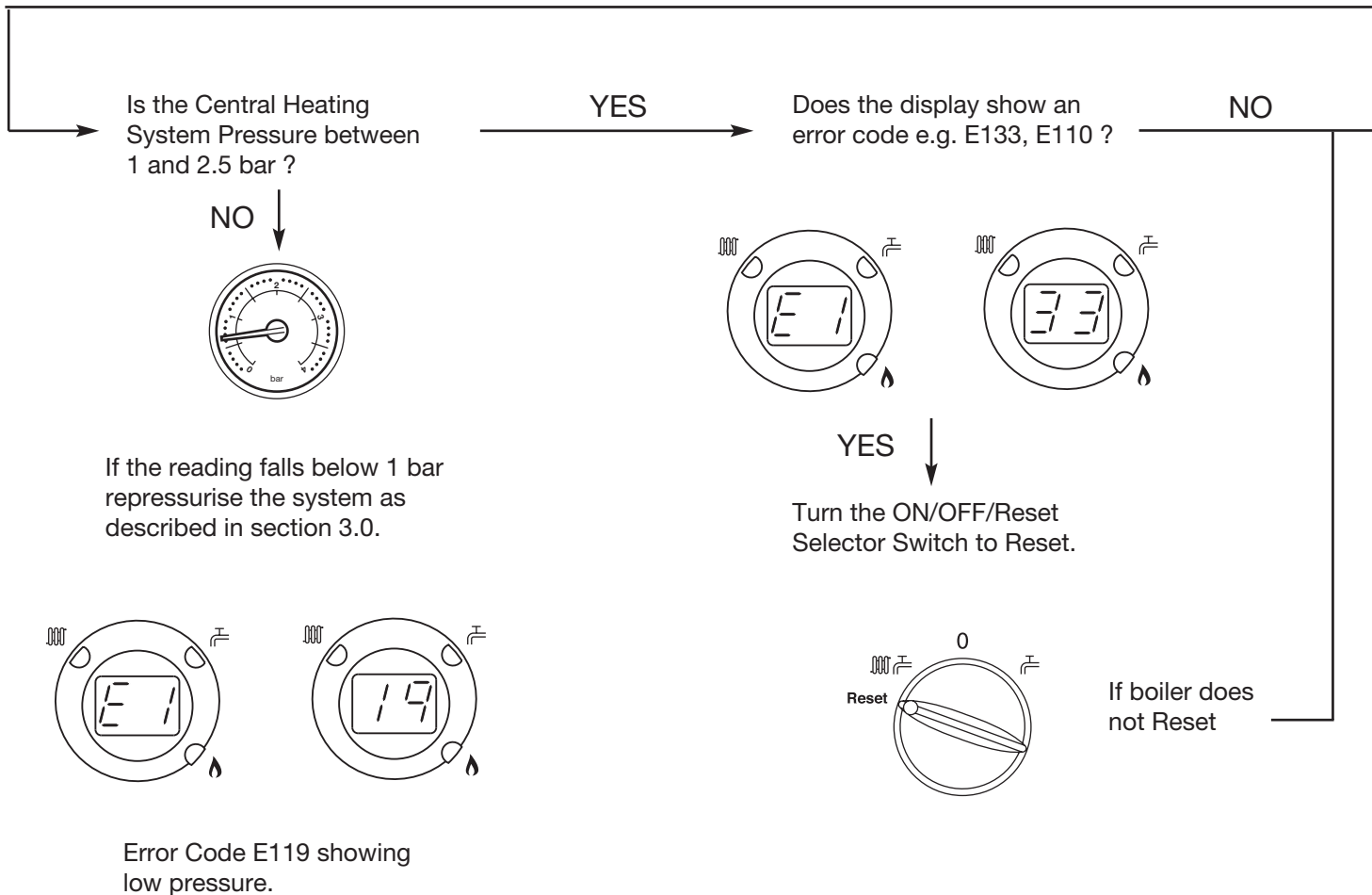
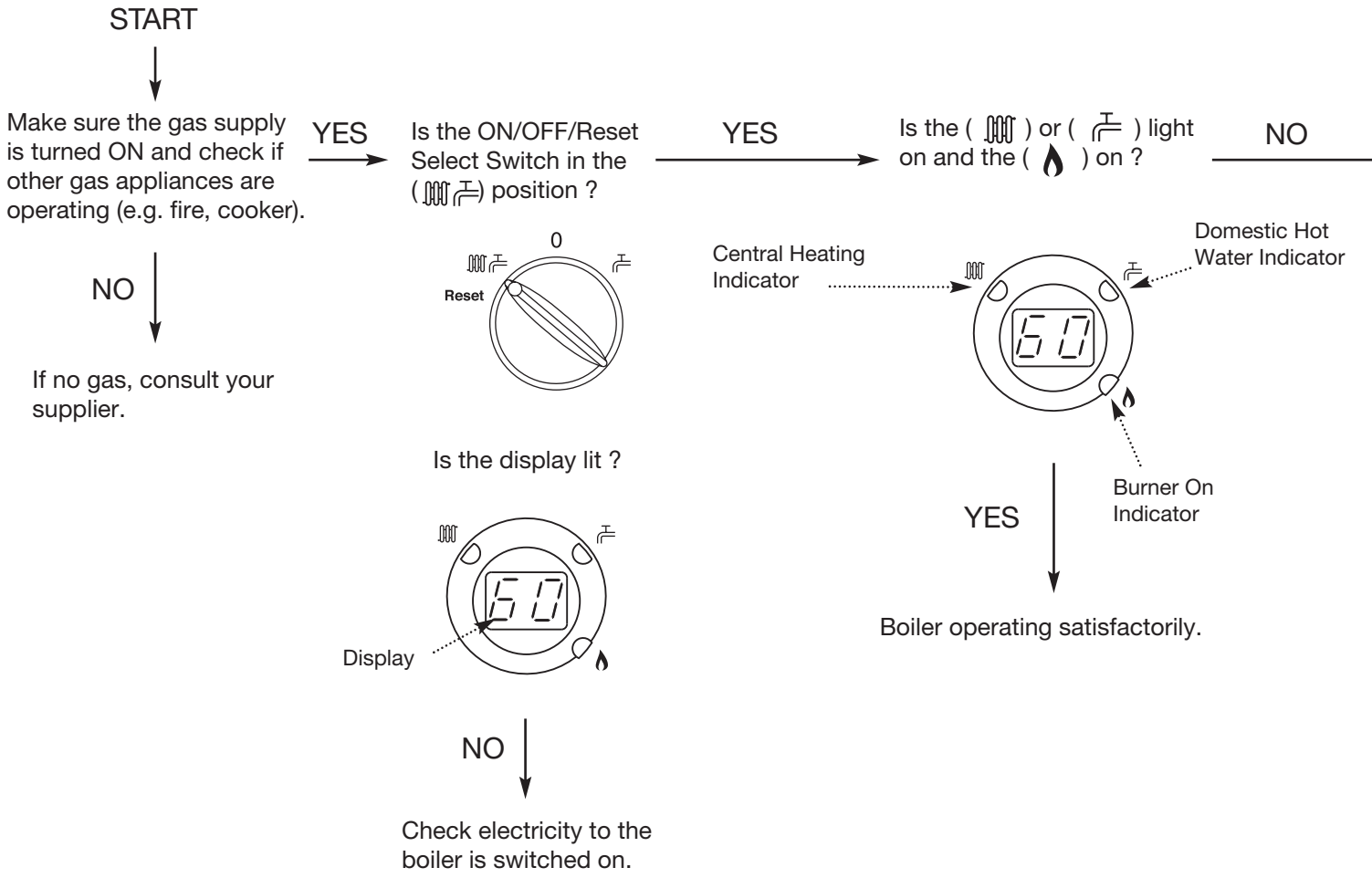

Is the Integral Programmer ON and calling for heat ?

YES

Is the Room Thermostat (if fitted) set high enough ?

YES

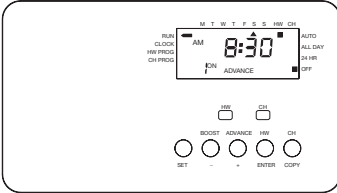

Ensure programmer is set for Central Heating ON or Hot Water ON (see section 7.4 for setting the programmer).

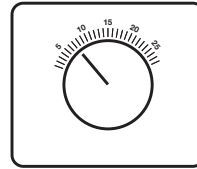

NO ↓

Turn Room Thermostat to maximum setting (typical example shown).

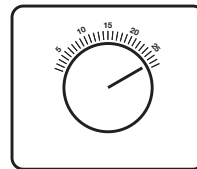

CONTACT YOUR INSTALLER OR SERVICE ENGINEER.

If you don't know what you need to do to get the boiler to light, or need help with the system and controls, contact your installer as soon as possible.

## 3.0 Repressurising System

### 3.1 Central Heating System Pressure

1. The normal operating water pressure is between 1 and 2.5 bar (Fig. 1). If the pressure exceeds 3 bar the safety pressure valve will operate and a fault is indicated. Contact your installer.

2. It may be necessary to repressurise the system occasionally (Fig. 2). A filling device (the filling loop) is fitted on the boiler itself.

3. The filling loop consists of two taps and a separate metal braided hose pipe.

4. Only when repressurising should the hose be connected between the two taps. No tools are necessary for this, but ensure that the wing nuts on the hose pipe ends are tightened onto the taps.

5. Fully open one of the taps first, and then while watching the pressure gauge, carefully open the second tap.

6. When the needle on the gauge is indicating 1 or more, turn both taps off.

7. Disconnect the hose from the taps (a small amount of water may be present) and remove it. Keep the hose in a safe place for future use.



Normal Pressure

Fig. 1



Requires  
Repressurising

Fig. 2

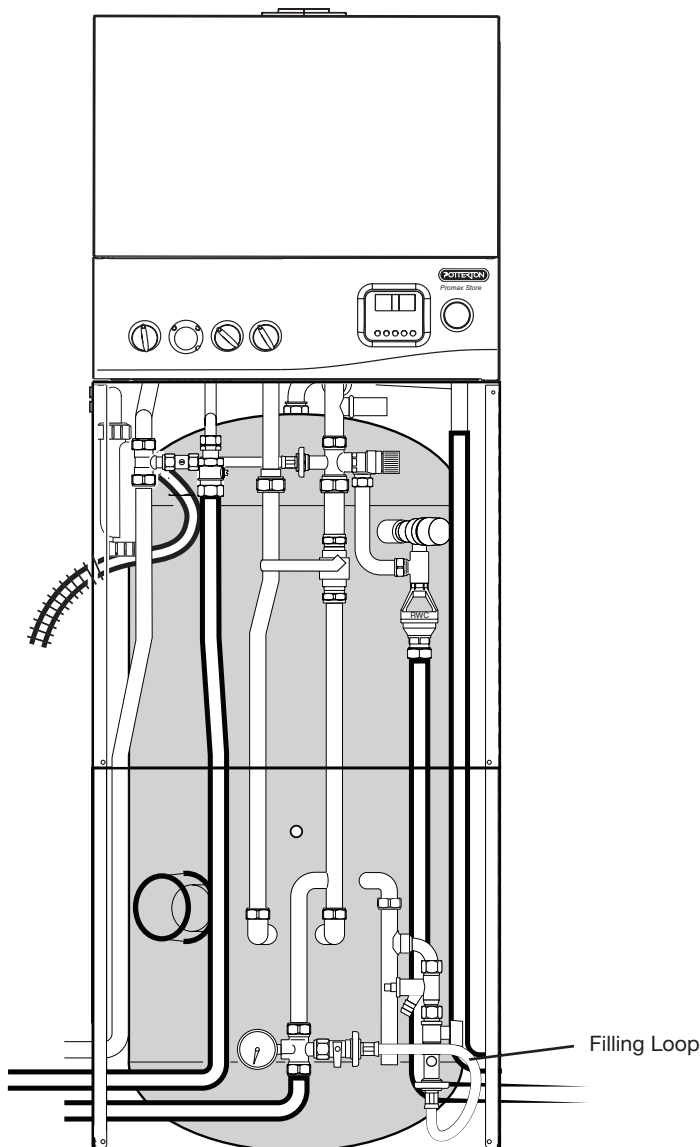

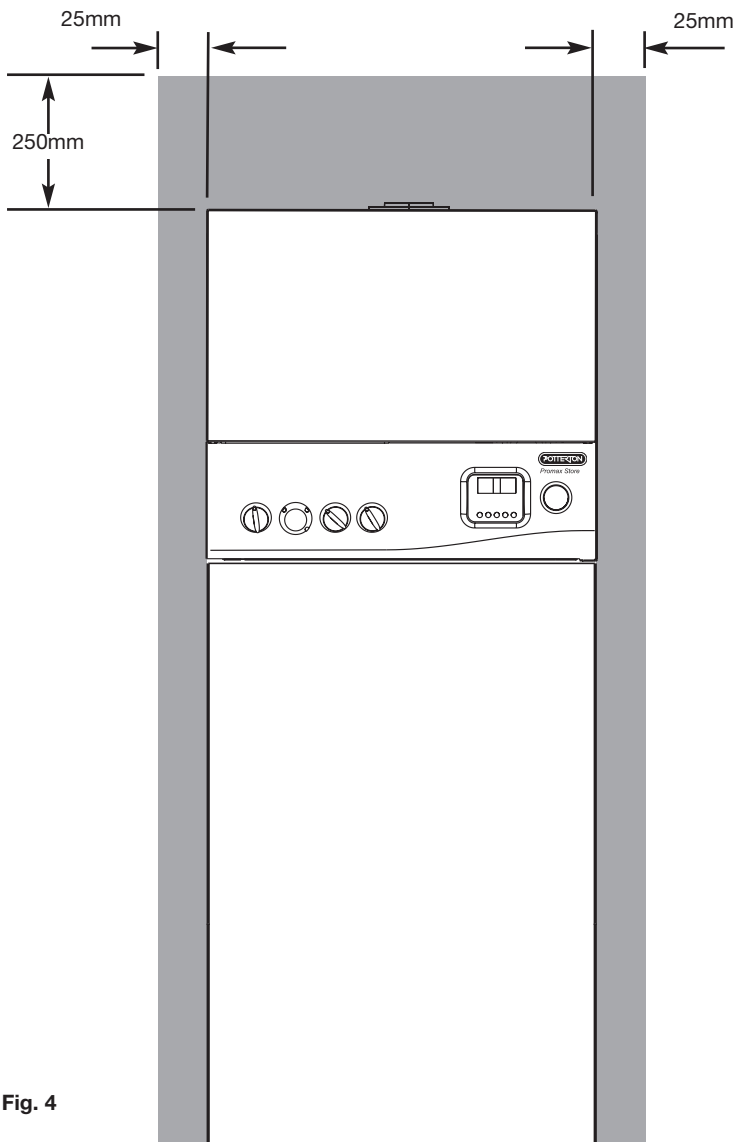

Fig. 4

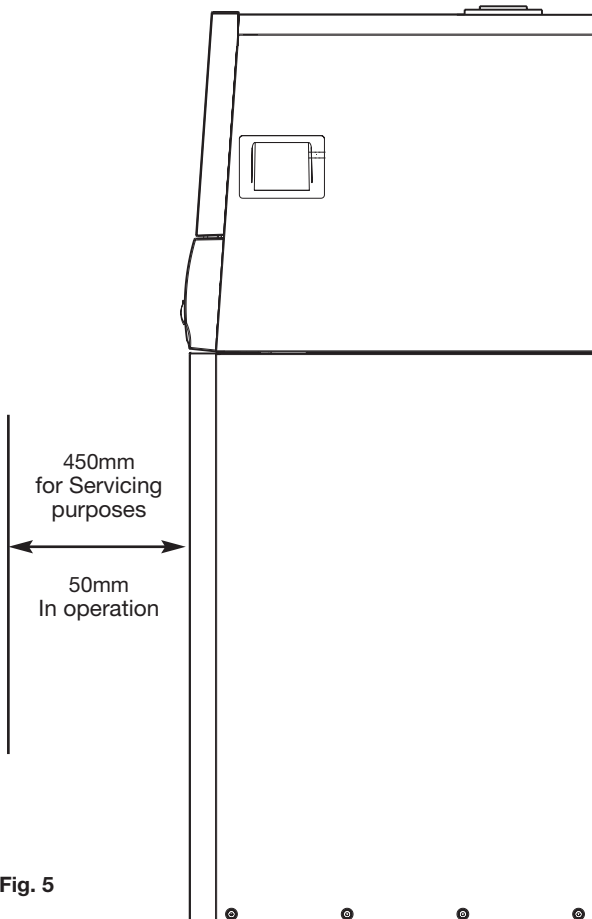

Fig. 5

## 4.0 Clearances

### 4.1 For your Safety

This appliance must have been installed in accordance with the manufacturer's instructions and the regulations in force.

Any modification that may interfere with the normal operation of the appliance without express written permission from the manufacturer or his agent could invalidate the appliance warranty. In GB this could also infringe the Gas Safety (Installation and Use) Regulations.

**GB** - Heating Industry definition meaning England, Scotland, Wales, Northern Ireland, Isle of Man and the Channel Isles

Your boiler must not be operated without the casing correctly fitted and forming an adequate seal.

Do not interfere with any sealed components on this boiler.

Take note of any warning labels on your boiler.

Your boiler should have the following minimum clearances for Safety and Maintenance (Fig. 4 & 5):-

Top	- 250mm
Left side	- 25mm
Right Side	- 25mm
Front	- 50mm (In Operation)
	- 450mm (For Servicing)

If your boiler is installed in a compartment, do not use it for storage purposes. Do not obstruct any purpose provided ventilation openings.

Flammable materials must not be stored in close proximity to your boiler.

Avoid skin contact when your boiler is in operation, as some surfaces may get hot i.e. pipework, flue.

Ensure that the flue terminal, outside the house, does not become damaged or obstructed, particularly by foliage.

It is important that the condensate drain system is not blocked, modified or damaged in any way as this would affect the operation of your boiler. Your installer should have insulated any exposed pipework.

## 5.0 Care of the Boiler

---

### 5.1 Cleaning the Outercase

1. The painted panels should be wiped with a damp cloth and then dried completely. DO NOT USE ABRASIVE CLEANING AGENTS.

---

### 5.2 Protection & Precautions

1. The boiler incorporates an integral frost protection feature that will operate in both modes. If the boiler temperature falls below 4° C, the boiler will fire until a temperature of 15° C is reached.

2. If a system frost thermostat has been fitted (your installer will be able to advise you), then to operate correctly and protect your system, the gas and electricity must be left on and the appliance set in the central heating mode.

3. The boiler incorporates an integral pump protection feature which monitors the time since the pump last operated and will operate the pump for approximately 1 minute if it has not run in the last 24 hours.

---



## 6.0 Legislation

### 6.1 Installation, Commissioning, Service & Repair

1. This appliance must be installed in accordance with the manufacturer's instructions and the regulations in force. Read the instructions fully before installing or using the appliance.
2. In GB, this must be carried out by a competent person as stated in the Gas Safety (Installation & Use) Regulations.
3. **Definition of competence:** A person who works for a Gas Safe registered company and holding current certificates in the relevant ACS modules, is deemed competent.
4. In IE (Eire), this must be carried out by a competent person as stated in I.S. 813 "Domestic Gas Installations".

**Lifting** - This product should be lifted and handled by two people. Stooping should be avoided and protective equipment worn where necessary. Carrying & lifting equipment should be used as required, e.g. when installing in a loft space.

---

All Gas Safe registered engineers carry an ID card with their licence number and a photograph. You can check your engineer is registered by telephoning 0800 408 5500 or online at [www.GasSafeRegistered.co.uk](http://www.GasSafeRegistered.co.uk)

---

The boiler meets the requirements of Statutory Instrument "The Boiler (Efficiency) Regulations 1993 No 3083" and is deemed to meet the requirements of Directive 92/42/EEC on the energy efficiency requirements for new hot water boilers fired with liquid or gaseous fuels:-

Type test for purpose of Regulation 5 certified by:  
Notified Body 0085.

Product/Production certified by:  
Notified Body 0086.

For GB/IE only.

### 6.2 Benchmark Commissioning Checklist

Please ensure that the installer has fully completed the Benchmark Checklist on the inside back pages of the installation instructions supplied with the product and that you have signed it to say that you have received a full and clear explanation of its operation. The installer is legally required to complete a commissioning checklist as a means of complying with the appropriate Building Regulations (England and Wales).

All installations must be notified to Local Area Building Control either directly or through a Competent Persons Scheme. A Building Regulations Compliance Certificate will then be issued to the customer who should, on receipt, write the Notification Number on the Benchmark Checklist.

This product should be serviced regularly to optimise its safety, efficiency and performance. The service engineer should complete the relevant Service Record on the Benchmark Checklist after each service.

The Benchmark Checklist may be required in the event of any warranty work and as supporting documentation relating to home improvements in the optional documents section of the Home Information Pack.

## 7.0 Programmer

### 7.1 Introduction

1. The built-in programmer is an electronic 7-day central heating and hot water control, designed to be easy to use and understand. Properly programmed it will help you save energy and create a comfortable environment in your home.

2. For convenience, morning and evening ON/OFF periods have been pre-set in the programmer 'memory' and will be retained, even if the mains power supply is interrupted. Details of these ON/OFF periods are given in the next section, together with step-by-step setting instructions.

3. In run mode, any combination can be set (using the ENTER and COPY buttons) e.g.

Hot Water Programme	C/Heating Programme
AUTO	AUTO
	or ALL DAY
	or 24 HOUR (Continuous)
	or OFF

4. The Promax programmer also offers the following features :

- \* Up to 3 On-Off time periods every 24 hours plus the option of programming different times for each day of the week.
- \* A central heating ADVANCE button allowing an instant switch from OFF to ON or ON to OFF without affecting normal settings.
- \* A hot water BOOST button giving an extra one hour period.

### 7.2 Buttons, Indicators & Symbols

Most of the control buttons on the programmer are dual purpose. They can be used as SET buttons for inputting time of day, ON/OFF times, etc, or as SELECT buttons for using the advance facility and choosing override programme options.

Figure 7 can be used to identify the SET buttons, indicators and symbols.

### 7.3 Setting the Programmer

1. Turn the appliance selector switch to central heating and hot water position.

2. Setting Day and Time

**NOTE:** When setting the day, time of day or switch times, if a period exceeding 60 seconds is allowed to elapse between button presses, the programmer will automatically return to normal RUN mode and any changes made since the last press of the ENTER button will not be saved.

i) Press the SET button so that the SET INDICATOR is pointing to the CLOCK position on the front of the programmer. the DAY OF THE WEEK INDICATOR will now flash (see Fig. 9).

Fig. 7

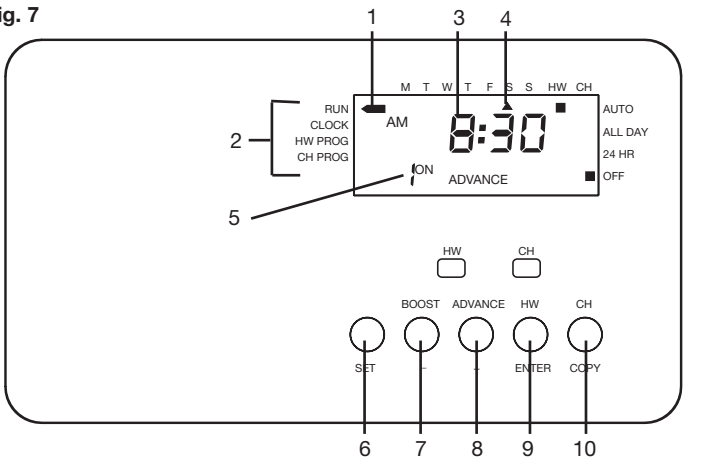

- 1 Set Indicator
- 2 Set Positions
- 3 Time of Day
- 4 Day of Week Indicator
- 5 ON/OFF Switch Period Symbol
- 6 SET Button
- 7 Minus (-) Adjust Button
- 8 Plus (+) Adjust Button
- 9 ENTER Button
- 10 COPY Button

THE RECOMMENDED COMBINATION IS :

Hot Water Programme	C/Heating Programme
ALL DAY	AUTO

The display should then look like this :



Fig. 9



## 7.0 Programmer

Fig. 10



Fig. 11



ii) Use the PLUS (+) or MINUS (-) to move the DAY OF THE WEEK INDICATOR to the current day of the week. Numbers relating to the day of the week are printed along the top of the programmer display, ie  
1=Monday, 2=Tuesday and so on.

iii) Press the ENTER button. The TIME OF DAY will now flash (Fig. 10).

iv) Now use the (+) or (-) BUTTONS to alter the display to the correct time of day making sure that the AM/PM SYMBOL is also correct (FIG. 11).

**NOTE:** By pressing and releasing the (+) or (-) buttons you advance or retard the time in 1 minute steps. If you keep the button depressed the display will fast cycle and the time can be changed more rapidly.

v) Press the ENTER button. Now use the SET BUTTON to return the SET INDICATOR to the RUN POSITION.

### 7.4 Setting 'ON' & 'OFF' Times

**NOTE:** The minimum ON or OFF period that can be set is ten minutes.

1. The integral programmer already has a factory pre-set suite of ON/OFF times in its memory. These are:

Monday to Friday		Central Heating	
Hot Water		1st ON	1st OFF
1st ON	1st OFF	6.30 am	9.00 am
6.00 am	9.00 am	2nd ON	2nd OFF
2nd ON	2nd OFF	12.00 pm	12.00 pm
12.00 pm	12.00 pm	3rd ON	3rd OFF
3rd ON	3rd OFF	5.00 pm	11.00 pm
4.30 pm	11.00 pm		

Saturday / Sunday		Central Heating	
Hot Water		1st ON	1st OFF
1st ON	1st OFF	7.30 am	10.30 am
7.00 am	10.30 am	2nd ON	2nd OFF
2nd ON	2nd OFF	12.00 pm	12.00 pm
12.00 pm	1.00 pm	3rd ON	3rd OFF
3rd ON	3rd OFF	4.30 pm	11.30 pm
4.00 pm	11.30 pm		

2. If these settings do not meet your own requirements then they can be easily changed as follows:

i) Press the SET BUTTON twice so that the SET INDICATOR is in a PROG position (HW or CH). The display will indicate the 'day' and the DAY OF THE WEEK INDICATOR will now flash.

ii) Use the (+) or (-) BUTTONS to move the indicator to the day of the week that you wish to change the times for. Press ENTER. The display will show '1 ON' and then first ON time for that day will flash (see Fig. 13).

iii) Adjust the flashing time as required by using the (+) and (-) buttons then press ENTER. The display will now show '1 OFF' and the first programmed OFF time for the day will flash (see Fig. 14).

iv) This can now be altered in the same way as the '1 ON' time mentioned above.

v) Follow the same procedure for the 2nd and 3rd ON/OFF times remembering to press ENTER after each change to the programme. If you do not wish to alter a particular time then simply press ENTER and the display will move on to the next ON/OFF time leaving the previous one unchanged.

Fig. 12



Fig. 13



Fig. 14



## 7.0 Programmer

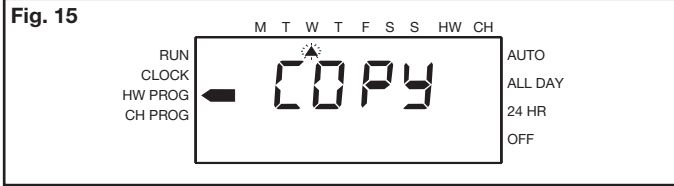

**NOTE:** The programmer provides up to three ON/OFF periods each day. If you do not want to use all these, a switch period can be cancelled by programming the ON operation for the same time as the OFF operation e.g. 2nd ON at 12.00 pm and 2nd OFF at 12.00 pm. When the 3rd OFF time has been entered the programmer will display the word COPY and the DAY OF THE WEEK INDICATOR will flash (see Fig.15).

If required these ON/OFF times can now be quickly copied so that they apply to any other day(s) you choose. This avoids separately programming days with identical switching times eg Monday to Friday. If not copying press ENTER and press SET button to return SET INDICATOR to run position.

**Fig. 16**

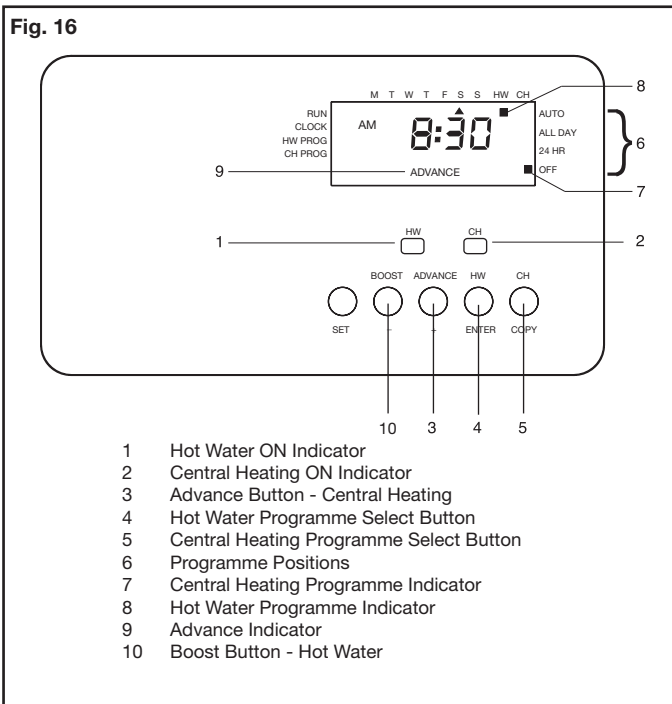

vi) Use the (+) and (-) BUTTONS to move the DAY OF THE WEEK INDICATOR to the next day that you wish the times to apply and press the COPY BUTTON, the display will indicate 'IN'.

Continue in this way until the programme has been copied to all the days that you wish it to apply to.

vii) When you have finished copying simply press ENTER. The word COPY will be replaced with 'day' and the DAY OF THE WEEK INDICATOR will flash.

3. You can now programme those days that require different times to the ones you have just copied by following the same procedure as described at the start of this section, parts ii to v.

### 7.5 Select Buttons, Indicators & Symbols

1. The following diagram (Fig.16) can be used to identify the SELECT buttons and indicators.

### 7.6 Programme Selection

1. The following programmes can be selected for either HOT WATER or HEATING or both together.

- AUTO:** When AUTO is selected the programmer will switch ON and OFF according to the switching times held in the memory, ie up to three ON/OFF periods per day.
- ALL DAY:** When ALL DAY is selected the programmer will switch the system on at the 1st ON TIME and OFF at the 3rd OFF TIME.
- 24 HOURS:** When 24 HOUR is selected the system remains on continuously, ignoring all the time settings.
- OFF:** When OFF is selected the programmer clock continues to operate but the system remains off.

2. To select a hot water programme press the HW PROGRAMME SELECT BUTTON until the HW (HOT WATER) PROGRAMME INDICATOR is pointing to the required programme, e.g. ALL DAY (see Fig. 17)

3. To select a central heating programme follow the same procedure using the CH PROGRAMME SELECT BUTTON.

**Fig. 17**

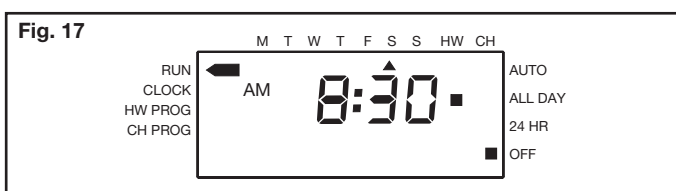

**NOTE:** When either HOT WATER or HEATING is switched to ON the relevant INDICATOR LIGHT will be illuminated (see Fig.16).

## 7.0 Programmer

Fig. 18

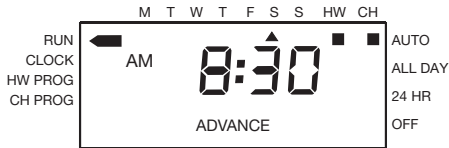
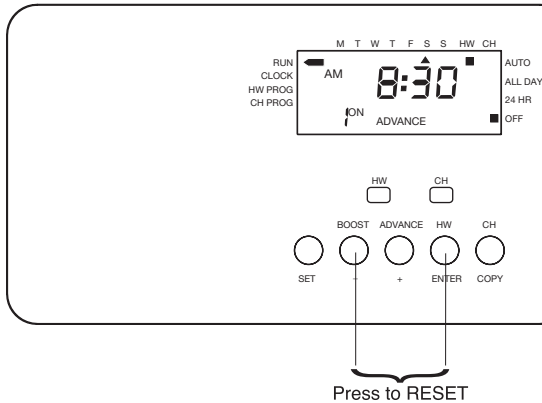

Fig. 19



### 7.7 Using the Advance and Boost Button

1. The ADVANCE facility allows you to bring forward the next heating ON or OFF period without having to alter the programmed ON/OFF times.
2. Press the ADVANCE BUTTON once and release. The word ADVANCE will appear in the display (see Fig.18).
3. If the programmer was originally ON it will now switch OFF and stay OFF until the next programmed ON time.
4. The opposite will apply if the programmer was originally OFF.
5. In both cases the unit will then revert to the normal programme times.
6. If you wish to cancel the advance simply press the ADVANCE BUTTON again and the word ADVANCE will disappear from the display.

**NOTE:** The ADVANCE facility has no effect when the CH PROGRAMME INDICATOR is in either the 24 Hour or the OFF position.

7. Pressing the BOOST button during an unprogrammed time for hot water will give a one hour period of hot water operation.

### 7.8 Programmer Faults

1. Electronic equipment can, in exceptional circumstances, be affected by electrical interference. If the display or switching programme becomes frozen or scrambled, or you wish to revert to the factory pre-set programme, you can RESET the programmer by pressing the MINUS (-) adjust button and the ENTER/HW SELECT BUTTON together (see Fig. 19).
2. After using the RESET procedure you will need to reprogramme the day and time of day plus any changes you wish to make to the factory pre-set programme.
3. The programmer is not user serviceable. DO NOT ATTEMPT TO DISMANTLE IT.
4. In the unlikely event of it developing a fault, contact your Gas Safe Registered Installer or Service Engineer, but before doing so try the RESET PROCEDURE above.
5. Should a replacement programmer be required your Installer can obtain this as Part No. 5117092.

### 7.9 Reserve Battery

1. The programmer is fitted with a NON-RECHARGEABLE LONG LIFE battery which will maintain the programmed ON/OFF settings for a period in excess of 2 years (Part No. 5118231).
2. This is more than sufficient to cover all the expected power interruptions during the life of the unit.

**NOTE:** If a power interruption of more than 48 hours occurs the 'time of day' will need to be re-adjusted once the power is restored.



### Warning !

#### If you smell gas

Turn off the gas supply at the meter and call your gas supplier immediately. Ventilate the property.

In GB, Transco operate a 24 hour emergency service and the telephone number will be listed in your telephone directory.

#### Faulty boiler

If it is known or suspected that a fault exists on the boiler, it must not be used until the fault has been corrected by a competent person.

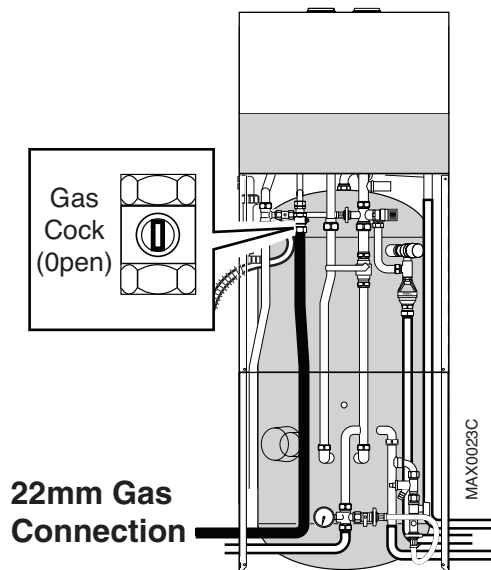

Fig. 20

#### In an Emergency

1. Turn off the electrical supply and turn the selector switch on the facia box to the OFF position.
2. Using a suitable open ended spanner or screwdriver turn the square on the gas tap to the left to isolate the gas supply (Fig. 20).
3. Call your Installer or Service Engineer as soon as possible.

## Please complete the boxes below

Serial Number

Date of Installation

Installer Details (name, address and contact number(s))

All descriptions and illustrations provided in this leaflet have been carefully prepared but we reserve the right to make changes and improvements in our products which may affect the accuracy of the information contained in this leaflet. All goods are sold subject to our standard Conditions of Sale which are available on request.

### POTTERTON

A Trading Division of Baxi Heating UK Ltd (3879156)  
A Division of Baxi Group  
Brooks House, Coventry Road, Warwick. CV34 4LL  
After Sales Service 0844 871 1560 Technical Enquiries 0844 871 1555  
Website [www.potterton.co.uk](http://www.potterton.co.uk)  
e&oe



## Standard Warranty Term & Conditions

### 12 Months Free Warranty - register today

To receive your 12 months free warranty please complete the form supplied with the boiler or simply call heateam, the service of Baxi Heating UK Ltd on 0800 731 1599.

### Our promise to you

If you experience a fault with your new boiler, we aim to provide a safe and high quality repair service supported by our dedicated national network of highly skilled engineers. If your installer can't resolve the problem for you, we will do everything we can to get an engineer out to you as quickly as possible. Nothing in this warranty will affect your statutory consumer rights.

### What you need to do if you experience a problem with your heating system or the operation of the boiler

You should always contact your installer first, because the fault may not be related to the boiler. If your installer confirms that the fault is within the boiler itself and he/she can't repair it, our friendly customer service team is on hand to help. Simply call our service division heateam on 0844 871 1560 to book an engineer visit or for any general advice that you may need. Our contact centre is open Monday to Friday 8am - 6pm, weekends and Bank Holidays 8.30am - 2pm, excluding Christmas Day and New Years Day.

When calling heateam it would be helpful if you could have the following information to hand:-

- 1 boiler serial number (see opposite).
- 2 boiler make and model number.
- 3 Your installer name and address details.
- 4 Proof of purchase (if you do not have the boiler serial number).

### What this warranty covers

Free of charge repair or replacement of components found to be faulty from manufacture.

Free of charge replacement of the complete unit provided always that the failure is related to a manufacturing fault that cannot be repaired or is uneconomic to repair.

The warranty runs for 12 months from the date your product is installed.

### What this warranty does not cover

Repairs to boilers which haven't been installed and commissioned properly, and as set out in the installation instructions (this includes the need to flush the system effectively and add a suitable corrosion inhibitor).

Any damage caused by hard water scale deposits and/or aggressive water resulting from corrosion.

Any other defects or failures, either in the connected heating system or outside of the boiler itself.

Faults caused by inadequate supply of electricity, gas or water to the property.

Installations within commercial settings for which this boiler was not designed.

Reimbursement of any third party repair or replacement costs that we haven't been told about or agreed with you in advance.

Compensation for consequential losses (e.g. loss of earnings, business losses, stress and inconvenience) arising from a production breakdown, including repair delays caused by factors outside our reasonable control.

### Annual Service

To ensure you receive the maximum efficiency from your boiler we recommend your boiler has an annual service so you and your family can continue to enjoy heating and hot water comfort. To arrange an annual service from one of our Baxi Heating UK Ltd heating experts, please call 0844 871 1545.