

PARAGON PANORAMA MODELS

Owner's Book

(THIS APPLIANCE IS FITTED WITH ALKALINE BATTERIES)

INCLUDES USER, INSTALLATION & MAINTENANCE
INSTRUCTIONS

Please read these instructions carefully before you start using the appliance

Keep this booklet handy for future reference

**This appliance is
for use in GREAT BRITAIN or IRELAND only**

A QUALITY PRODUCT FROM PARAGON FIRES

PARAGON PANORAMA Instructions

CONTENTS

CONTENTS	PAGE
User Instructions	
SECTION ONE Introduction	3
Consumer Protection	3
Health and Safety	3
Introduction	3
SECTION TWO Operation	5
To Light the Appliance	5
Replacing Batteries (Hand Set and Appliance)	5
SECTION THREE Cleaning	6
Trim, Fret or Fascia	6
Black Painted Surfaces	6
Pilot	7
SECTION FOUR Fuel Bed Cleaning and Layout	7
INSTALLATION INSTRUCTIONS	
SECTION FIVE Specification	14
SECTION SIX Regulations and Warnings	15
Ventilation	16
Clearance to Shelves	16
Clearance to Side	16
SECTION SEVEN Appliance Installation	16
Hole in the Wall	16
Connecting to the Gas Supply	18
Checking Gas Soundness	18
Fit Battery Pack	18
Checking Product Clearance	19
Positioning Remote Control Eye	19
Checking Operation of Fire	19
Advise Customer That	19
MAINTENANCE INSTRUCTIONS	
SECTION EIGHT Maintenance	20
Fuel Bed Cleaning	20
Replacement of Gas Control	20
Replacement of Injector	20
Replacement of Control Unit (EDB)	20
Replacement of Pilot Assembly	20
Wiring Diagram	20
Warranty Cover	21

PARAGON Panorama Users Instructions

SECTION ONE Introduction

Consumer Protection Information

As manufacturers and suppliers of heating products, we take every care, as far as is reasonably practicable, that these products are so designed and constructed as to meet the general safety requirement when properly used and installed. To this end, our products are thoroughly tested and examined before despatch.

IMPORTANT NOTICE: Any alteration that is not approved by the appliance manufacturer could invalidate the approval of the appliance, operation of the warranty and could affect your statutory rights.

Health and Safety Notice

Important

This appliance could contain some of the materials, indicated below, that could be interpreted as being injurious to health and safety. It is the users / installers responsibility to ensure that the necessary personal protective clothing is worn when handling these materials, see below for information.

Artificial Fuels, Mineral Wool, Insulation Material, Refractory/Ceramic Fibres, Glass Yarn - may be harmful if inhaled, may be irritating to skin, eyes, nose and throat.

When handling avoid inhaling and contact with skin or eyes. Use disposable gloves, face masks and eye protection. After handling wash hands and other exposed parts. If a vacuum is used for cleaning the fuel bed or cleaning after servicing / installation it is recommended that it be of the type fitted with a HEPA filter.

Disposal of refractory/ceramic materials. To keep dust to a minimum these materials should be securely wrapped in polythene and be clearly labelled 'RCF waste'. These materials are not classified as 'hazardous waste and should be disposed of at a site licensed for the disposal of industrial waste.

INTRODUCTION

- The PARAGON PANORAMA incorporates a single gas control, which selects ignition pilot, with variable setting between low and high settings and is operated via remote control. The system is powered by a battery pack; therefore no mains electrical supply is required.
- The PARAGON PANORAMA has been designed and tested to the requirements of EN 509 and is suitable for use in GB (Great Britain) and IE (Ireland).
- This appliance is intended for decorative purposes.
- The PARAGON PANORAMA is available in **Natural Gas Only**). The markings **G20** for natural gas on the packaging and the data badge specify the gas for which the appliance has been factory set. **Note: These appliances should only be used on the appropriate gas specified. They are not suitable for conversion from one gas to the other.**
- The pilot can be left on (standby setting) or the pilot can be extinguished and relit each time the fire is used.
- The appliance incorporates a safety device in the form of an Oxygen Depletion System, which constantly monitors the oxygen in the room and will cause the fire to switch off if the oxygen level reduces, for instance due to insufficient ventilation or a blocked flue. If this regularly occurs do not attempt to relight the appliance until a qualified engineer has checked it, the problem may not be due to lack of air or a defective flue.

VENTILATION

Permanent ventilation is not normally required, subject to advantageous ventilation being established via the spillage test.

In the Republic of Ireland, permanent ventilation must be provided in accordance with the regulation in force (I.S. 813).

SECTION ONE Introduction Cont.

The PARAGON PARORAMA is battery operated; therefore no mains electrical supply is required. Power to the appliance is provided by 6 high power alkaline 1.5V batteries (AA size) (a spare set of 6 AA batteries is supplied with the appliance); these batteries can be changed to Nickel Metal Hydride rechargeable batteries providing they have a minimum capacity of 2200 mAh. A set of 6 high power alkaline 1.5V batteries (AA size) would give in the order of 200 -380 operations while 6 rechargeable batteries when fully charged would give approximately 200-300 operations. These figures are only given for guidance and may vary depending on how the appliance is used and the battery manufacturer and quality.

A special long life lithium battery is available as an optional extra and would be expected to give in excess of 12 months normal use (a minimum of 1000 operations), however it is not subject to the guarantee. For more information call the telephone number located on the back of this booklet.

Using the standby facility when the appliance is switched off for short periods can extend battery life. The standby facility switches off the mains gas supply to the appliance but the pilot remains alight.

An audible double bleep warning indicates that the appliance batteries need changing or charging (if rechargeable batteries have been used).

Important: Batteries should be changed or recharged as soon as possible as the appliance will not light if the battery power gets to low.

In GB, the appliance must be installed by a competent person i.e. CORGI-registered, in accordance with the GAS SAFETY (INSTALLATION AND USE) REGULATIONS, The Building Regulations (or The Building Regulations (Scotland) or The Building Regulations (Northern Ireland)) and The Current I.E.E. Wiring Regulations, if appropriate.

In IE, the appliance must be installed by a competent person and installed in accordance with the current edition of I.S.813 Domestic Gas Installation, the current Building Regulations and the current ETCl rules for electrical installation, if appropriate.

It is important that: -

- The air slot located along the full width of the trim base **IS NOT** obstructed.
- When installed in 'Hole in the Wall' situations the area immediately in front of the appliance must always be kept clear of combustible items other than the floor covering (which must be fixed).
- The chimney or flue is checked annually to ensure clearance of combustion products.
- Any purpose-built ventilation should be checked periodically to ensure freedom from obstruction.
- Any debris falling onto the fuel bed should be removed after allowing the appliance to cool completely. An optional debris deflector kit is available from your retailer, if required. Your installer must fit this, as a spillage test must be carried to confirm continued safe operation of the appliance.
- During initial firing an odour may be evident. This is the binder used during the manufacture of the fibre components and there are no harmful effects produced.
- Rubbish must not be thrown onto the coal/pebble bed under any circumstances.
- The chimney or flue (unless new or previously used with a gas appliance) must be swept before installation if it has been used for solid fuel.
- It is advised that this appliance is serviced annually; this is more likely to provide trouble-free operation.
- This appliance has a naked flame, as with all such fires it is recommended that a fireguard should be used for the protection of children, the elderly, and infirm. Fireguards should conform to BS 6539 (1984) (Fireguards for use with solid fuel appliances).

PARAGON PANORAMA Users Instructions

SECTION ONE Introduction Cont.

- Like all appliances incorporating an aerated burner a low frequency noise may be heard, this may be more noticeable on the low setting.
- During the normal operation of the fire some black staining may appear on some parts of the fuel bed. This is quite normal and adds to the appearance of the appliance. However, if excessive black staining does occur it may be due to the fuel bed being incorrectly laid. This should be checked against the Fuel Bed Layout in Section Three, prior to contacting a service engineer.





SECTION TWO Operating the Appliance

Before attempting to operate the appliance check that nothing has been placed in front of the appliance that may interfere with the remote sensor operation.

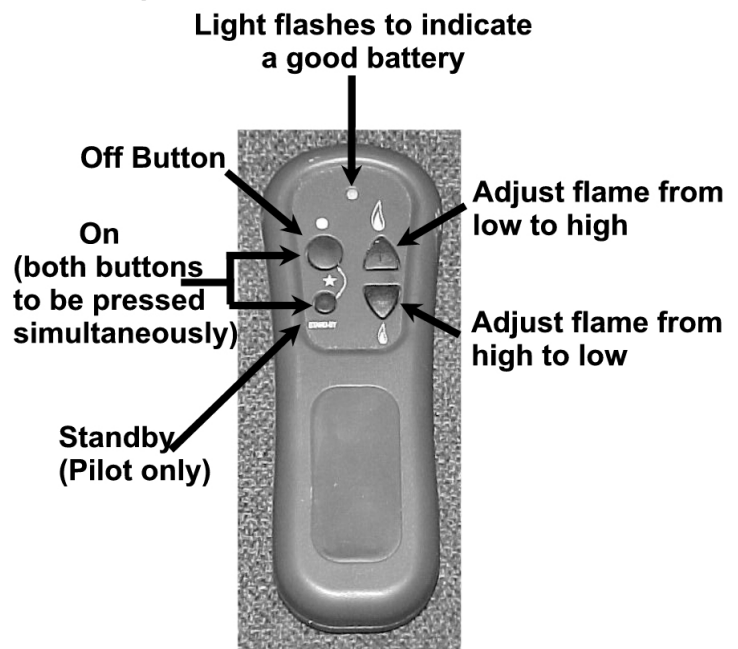
To light the appliance using the remote hand set:

- a. Point the remote control hand set in the direction of the appliance and simultaneously press the buttons marked '●' and 'standby'. Continue to hold in these two buttons until a 'bleep' is heard (approximately 2-3 sec.) and then release these buttons. The appliance will automatically go through the ignition sequence and the pilot should ignite. Once the pilot is alight the appliance will automatically go to the high setting (approximately 20-25sec). If the ignitor stops sparking and the pilot fails to light repeat this procedure.
- b. If the ignitor stops sparking and the pilot fails to light press the ● button before repeating this procedure.



- c. The appliance can be adjusted up or down by pressing the appropriate button  (low setting) or  (high setting). These buttons have a dual function. If they are pressed until a 'bleep' is heard and then released immediately the appliance will automatically go to the maximum  or minimum settings . On the other hand if the button is not released, gradual adjustment is made until the button is released or until the maximum or minimum setting is reached.
- d. To switch off the appliance press the ● button or if the appliance is to be switch off for a short period it is recommended that the 'standby' button be used. This switches the main burner off but leaves the pilot on and will extend battery life.
- e. The appliance can be switch off with out using the hand set by removing the appliance batteries located behind the ash pan cover. When the batteries are removed there will be a delay (up 3minutes) after which double bleeps may be heard and shortly after the appliance will extinguish. Ensure that the battery is reconnect once the fire as been extinguished. The appliance cannot be operated without the use of the handset.

NOTE: If the fire is extinguished for any reason wait 3 minutes before relighting.

PARAGON PANORAMA Users Instructions

SECTION TWO Operating the Appliance Continued

Low Battery Indication (Hand Set)

If while pressing any of the buttons on the remote hand set the low battery indicator lamp either stops flashing or appreciably slows then the battery should be changed.

To Replace Battery In Hand Set (9v Size Mn1604 Or 6f22)

Remove the cover from the rear of the handset and fit replacement battery. Take care not to strain the battery connections.

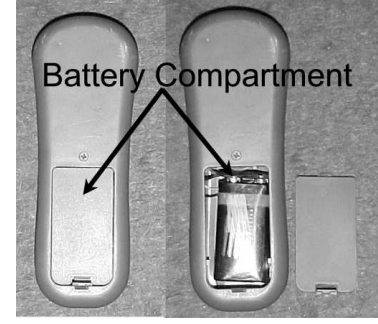

Low Battery Indication (Appliance)

If you hear a double 'bleep' sound come from the appliance this indicates the appliance battery pack is low and should be changed as soon as possible. The appliance will continue to work normally for a short period but if the warning is ignored you may experience difficulty lighting the appliance or the appliance may automatically switch off for no apparent reason.

NOTE: The appliance cannot be used when the battery is completely flat.

To replace appliance batteries (6 high power alkaline aa 1.5v)

(Rechargeable batteries can be used providing they are a nickel metal hydride type 1.5V AA with a minimum capacity of 2200mAh).

(A long life lithium battery is available as an optional extra call the number shown on the last page of these instructions for further information).

- Remove the decorative trim.
- Remove insulation blanket and replace the six high power alkaline AA batteries as a complete set or recharge as appropriate. **WARNING, batteries will overheat if fitted incorrectly, when fitting the batteries ensure that they are fitted as per the marking on the rear of the holder (i.e. minus of battery against spring).** If rechargeable batteries are used they MUST be a Nickel Metal Hydride type with a minimum capacity of 2200mAh.

- If the appliance is fitted with the special lithium battery (optional) disconnect the wires at the battery connector and remove battery from insulation blanket. Fit replacement battery, ensuring the connection is made correctly and refit insulation blanket.

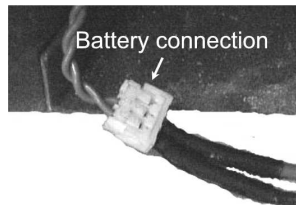

BATTERY CONNECTION

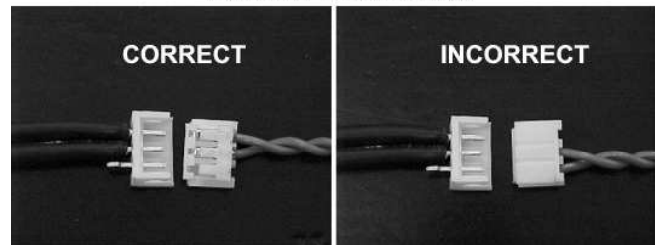

- Refit trim.

SECTION THREE Cleaning

Warning: -

Before you clean any part of the appliance ensures that the appliance is turned off isolated from the electrical supply and is cold.

CLEANING: TRIM, FRET or FASCIA (Not Stone or Stone Effect Finishes)

Abrasive or chemical cleaner should **never** be used. The fret and trim may be cleaned with a clean damp cloth.

N.B The trim and fire fret should be removed for cleaning. (The trim is held in place by magnetic strips).

CLEANING: BLACK PAINTED SURFACES

- These surfaces should be dusted regularly and any marks removed with a soft cloth.
- Abrasive or chemical cleaner should **never** be used.

PARAGON PANORAMA Users Instructions

CLEANING: PILOT

Pilot Cleaning (Before cleaning ensure that the appliance is turned off and cold)

In some instances you may experience ignition problems even when the appliance is new. This may be due to the aeration hole in the pilot body (see photograph) being partial blocked with dust, pet hairs, or other foreign matter. The source of this debris could be such things as carpet fibres, decorating or pet etc.

To clean the pilot, carefully remove the decorative trim.

Note: - *If the remote eye is fitted to the base of the trim it must be removed from the fixing clip before the trim is removed.*

The pilot is located on the right hand side of the appliance, any debris in or around the aeration hole should be removed using the nozzle of a vacuum cleaner. It is advisable not to

blow the debris into the hole as this may cause more of a restriction and not rectify the problem.

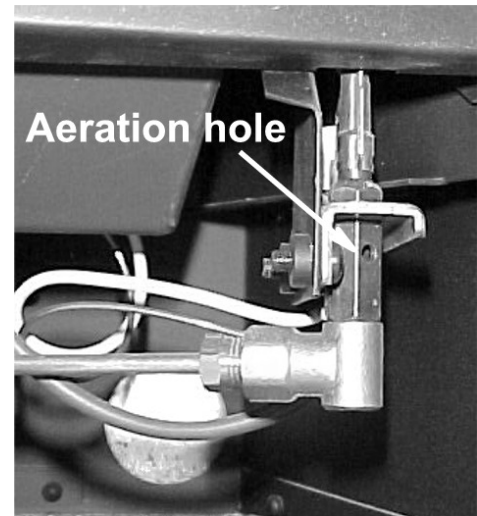

SECTION FOUR Fuel Bed Cleaning and Layout

Important: - *Refer to the 'Health & Safety Notice located on page 3 of this booklet before cleaning or replacing any refractory material.*

The fuel bed components are delicate and they should be handled with great care.

The loose parts and moulded shapes may be removed for cleaning. They can be brushed very gently with a soft brush to remove dust or any deposits.

A vacuum cleaner may only be used after the loose components and moulded shapes have been removed.

CARE SHOULD BE TAKEN TO AVOID CONTACT WITH THE REFRACTORY LINING THIS IS A DELICATE SURFACE AND SHOULD **NOT** BE WIPED OR RUBBED.

FUEL BED LAYOUT

Fuel Bed Components

- Rear Matrix
- Front Matrix
- Loose Pebble Set
- Loose Coal Set
- Loose Twig Set

WARNING

Obstructing the burner outlet with the Front Matrix may result in the control overheating and incorrect performance.

Twig fuel bed layout

- Locate the FRONT MATRIX Ensure that its in front of the two metal flanges and DO NOT cover the burner outlet.
- Ensure the REAR MATRIX is in position as shown located against the rear edge of the burner outlet.
- Ensure the LEFT SIDE MATRIX is located against the side of the REAR MATRIX and sits at the rear of the FRONT MATRIX.
- Ensure the RIGHT SIDE MATRIX is located against the side of the REAR MATRIX and sits at the rear of the FRONT MATRIX.



PARAGON PANORAMA Users Instructions

SECTION FOUR Fuel Bed Cleaning and Layout cont.

- Lay a row of numbered twigs as shown.

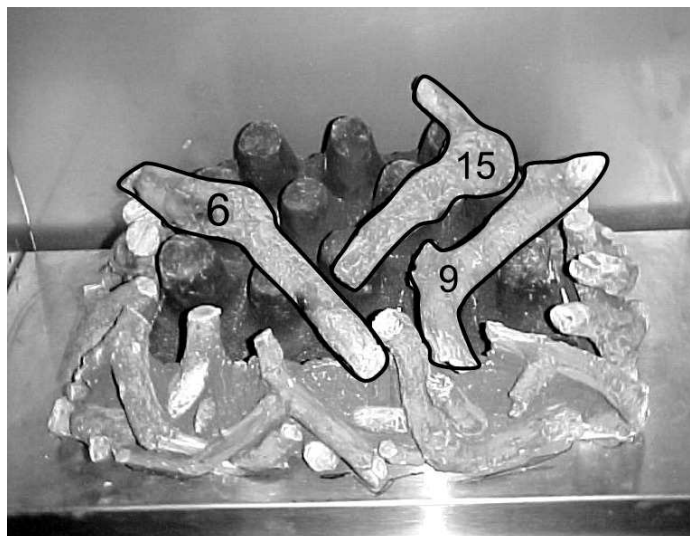

- Lay another row of loose twigs as shown.



- Lay another row of loose twigs as shown.



SECTION FOUR Fuel Bed Cleaning and Layout cont.

- Lay another row of loose twigs as shown.

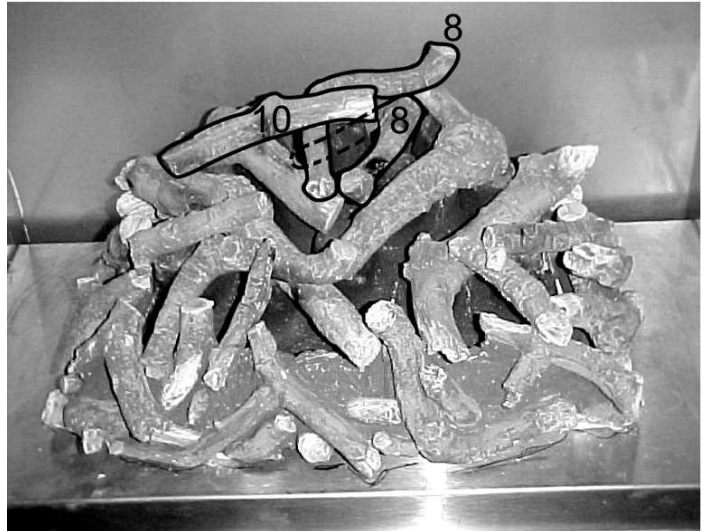

- Place the brick shapes around the edge of the front and side matrix as shown.



Pebble fuel bed layout

- Ensure the REAR MATRIX is in position as shown located against the rear edge of the burner outlet.

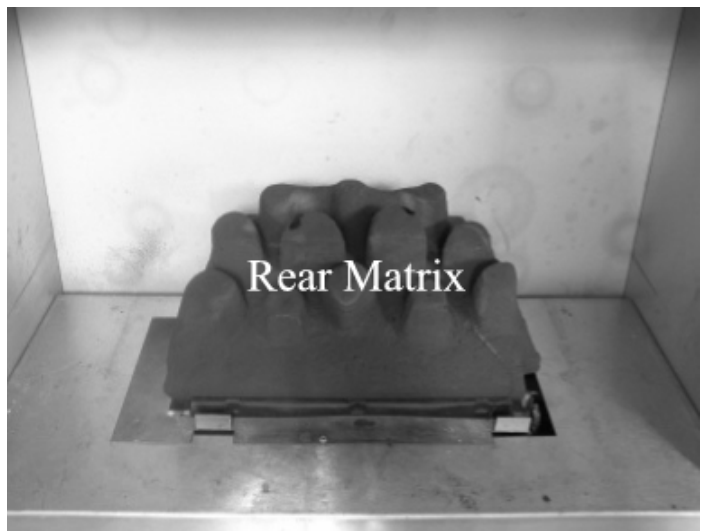

PARAGON PANORAMA Users Instructions

SECTION FOUR Fuel Bed Cleaning and Layout cont.

- Locate the FRONT MATRIX Ensure that it is in front of the two metal flanges and DO NOT cover the burner outlet.

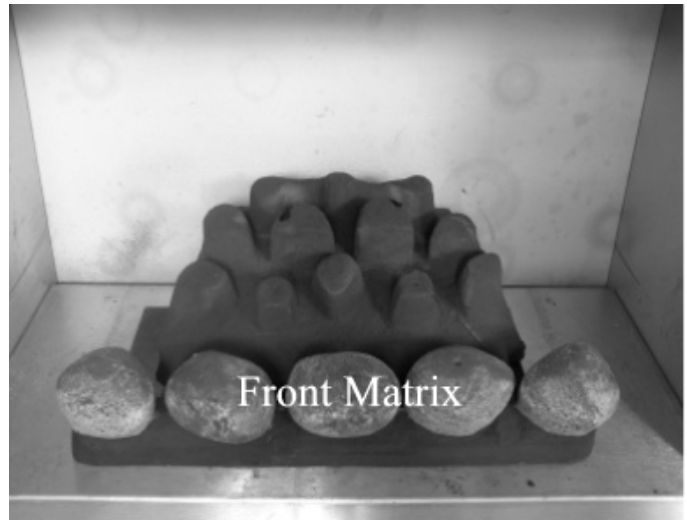

- Ensure the LEFT SIDE MATRIX is located against the side of the REAR MATRIX and sits at the rear of the FRONT MATRIX.
- Ensure the RIGHT SIDE MATRIX is located against the side of the REAR MATRIX and sits at the rear of the FRONT MATRIX.

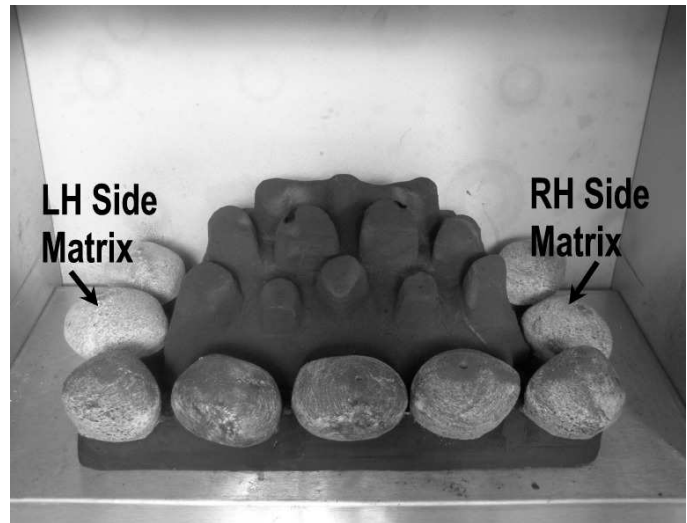

- Lay another row of loose Pebbles as shown.

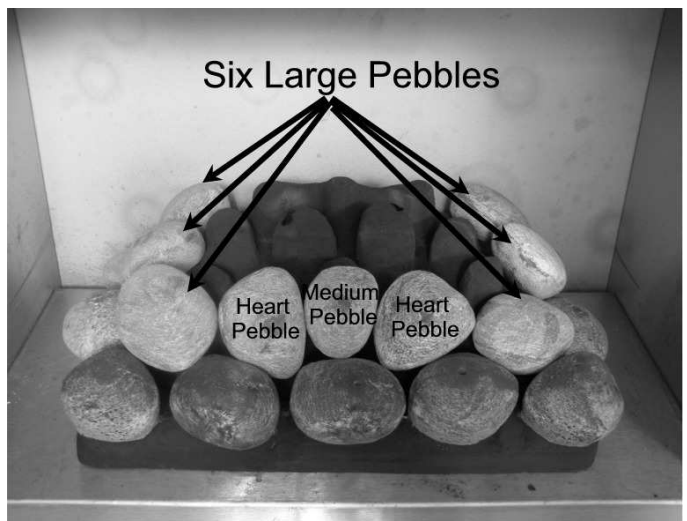

PARAGON PANORAMA Users Instructions

SECTION FOUR Fuel Bed Cleaning and Layout cont.

- Lay another row of loose Pebbles as shown.

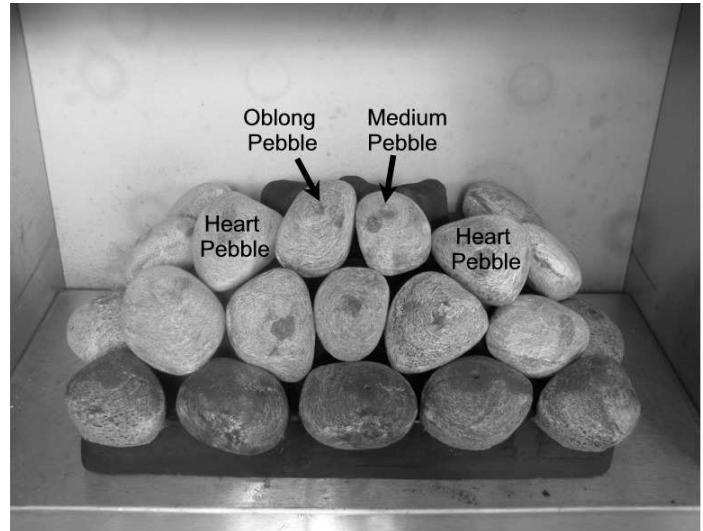

- Lay another row of loose Pebbles as shown.



- Place the Bark shapes around the edge of the front and side matrix as shown.

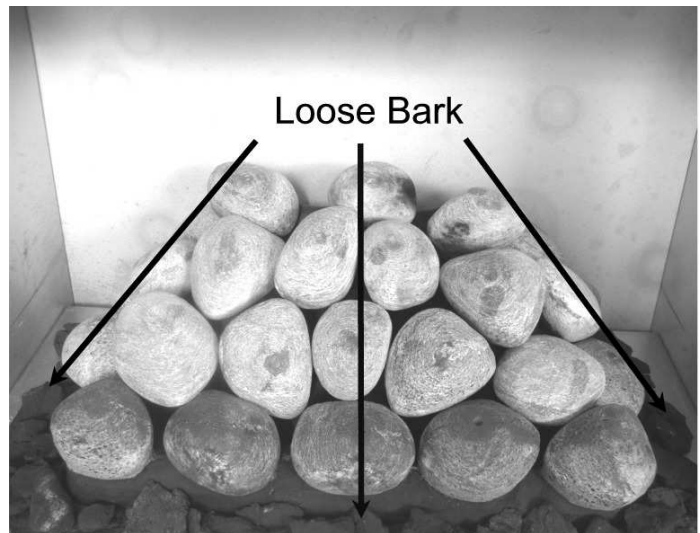

PARAGON PANORAMA Users Instructions

SECTION FOUR Fuel Bed Cleaning and Layout cont.

Coal fuel bed layout

- Ensure the REAR MATRIX is in position as shown located against the rear edge of the burner outlet.

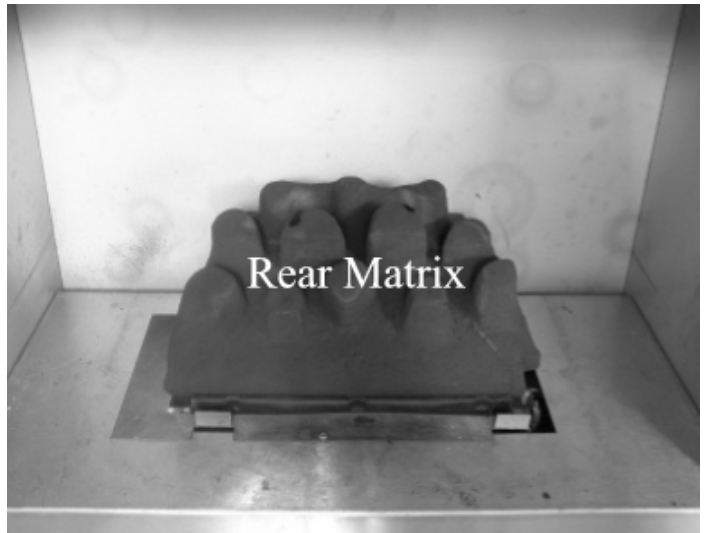

- Locate the FRONT MATRIX Ensure that its in front of the two metal flanges and DO NOT cover the burner outlet.

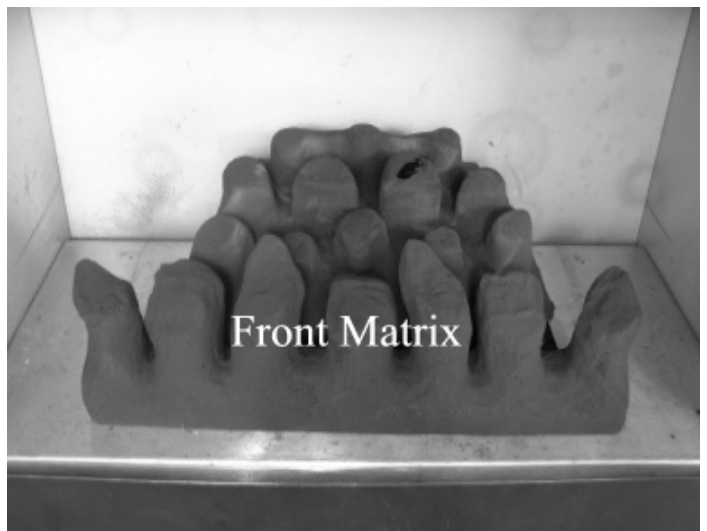

- Ensure the LEFT SIDE MATRIX is located against the side of the REAR MATRIX and sits at the rear of the FRONT MATRIX.
- Ensure the RIGHT SIDE MATRIX is located against the side of the REAR MATRIX and sits at the rear of the FRONT MATRIX.

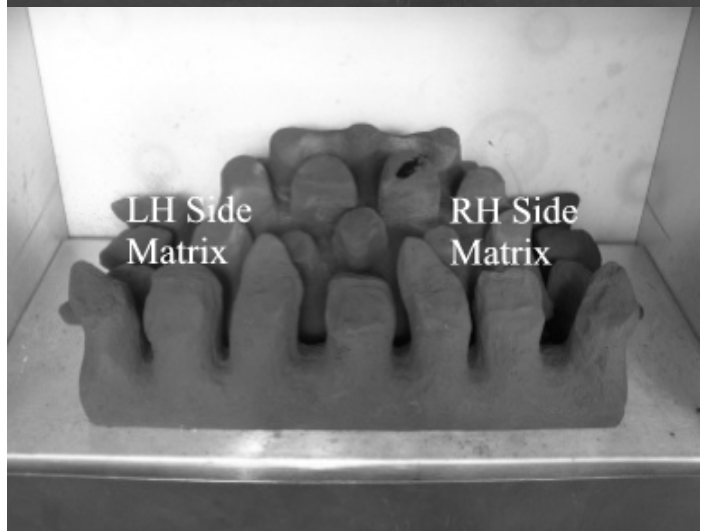

PARAGON PANORAMA Users Instructions

SECTION FOUR Fuel Bed Cleaning and Layout cont.

- Lay another row of loose Coals as shown.

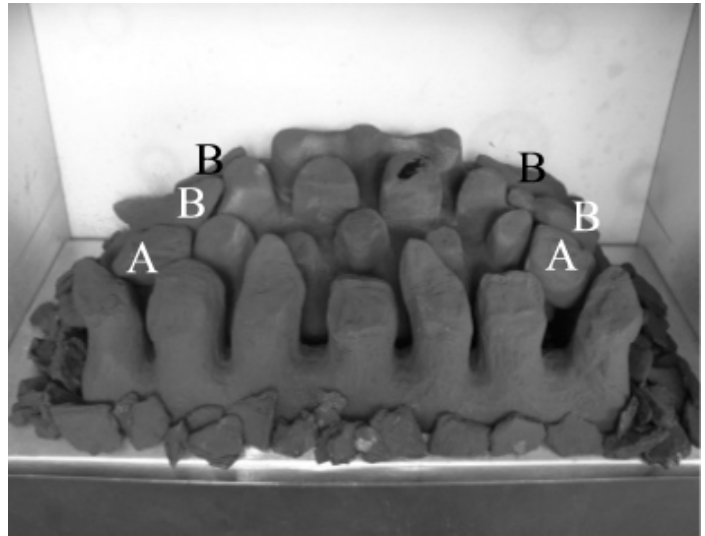

- Lay another row of loose Coals as shown.

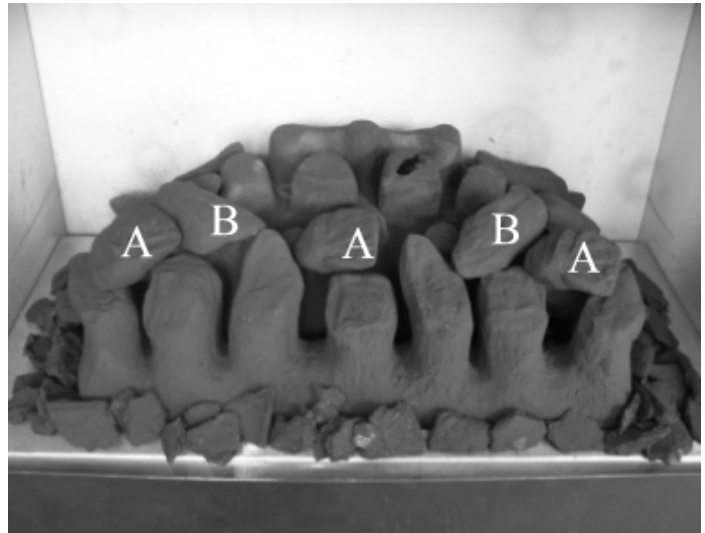

- Lay another row of loose Coals as shown.

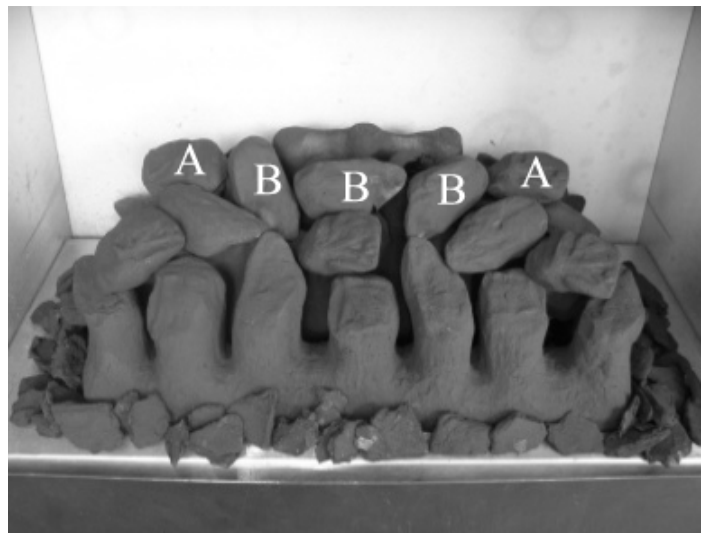

PARAGON PANORAMA Users Instructions

SECTION FOUR Fuel Bed Cleaning and Layout cont.

- Place the Bark shapes around the edge of the front and side matrix as shown.

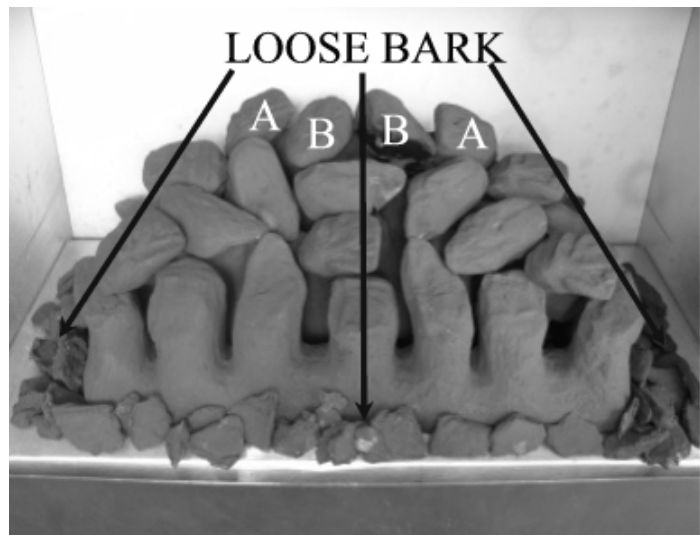

Servicing

It is advised that the PARAGON PANORAMA fire are serviced annually, this is more likely to provide trouble-free operation. A competent person must carry this out, i.e. CORGI Registered Installer in accordance with the current Gas Safety (Installation and Use) Regulations. The chimney or flue should be checked annually to ensure clearance of combustion products.

Ventilation in the United Kingdom

Appliances in the PARAGON PANORAMA range may require purpose-built ventilation, if for any reason purpose-built ventilation is provided it should be checked periodically to ensure freedom from obstruction.

PARAGON PANORAMA Installation Instructions

SECTION SEVEN Regulations and Warnings Cont.

The Paragon Panorama MUST only be used in sufficiently ventilated rooms.

Read instructions carefully before installation and use.

The following are the relevant Codes of Practice and British Standards: -

BS 5871

BS 8303

BS 5440 Part 1 and Part 2

BS 1251

BS 6891

BS 6461 Parts 1 & 2

BS 715

Note:- This appliance must be installed to current versions of the above standards and include any relevant amendments.

The Building Regulations issued by the Department of the Environment.

The Building Standards (Scotland) (Consolidation) Regulations issued by the Scottish Development Office.

WARNING

This appliance has a naked flame, as with all such fires it is recommended that a fireguard should be used for the protection of children, the elderly and infirm. Fireguards should conform to BS 6539 (1984) (Fireguards for use with solid fuel appliances).

Prior to installation, ensure that the local distribution conditions and the adjustment of the appliance are compatible. For natural gas appliances, G20 @ 20mbar appliance.

VENTILATION

In GB (Great Britain) permanent ventilation is not normally required, subject to advantageous ventilation being established via the spillage test.

In IE (*Republic of Ireland*) permanent ventilation must comply with I.S. 813.

CLEARANCE TO SHELVES

Minimum clearance to underside of a 150mm (6ins) combustible shelf from the top of the fire opening must be 140mm (5 1/2ins). Add 12.7mm (1/2 in) to this clearance for every 25mm (1in) increased depth of shelf.

CLEARANCE TO SIDE

Minimum clearance required to any combustible material to the side of the appliance must be 160mm (6 1/4 ins).

SECTION SEVEN APPLIANCE INSTALLATION

- Prior to any installation-taking place, the flue must be checked for satisfactory operation, a smoke test must be carried out to determine that all the smoke is drawn into the flue.
- The builders opening must be constructed of non-combustible material.
- Any permanent flue restriction must be removed and any variable dampers locked fully open or removed. The chimney flue must be swept prior to installation unless new. The gas installation must use rigid or semi-rigid tube.
- A non-combustible surface must be provided beneath the appliance within the fireplace opening. The surface must be at least 105mm from the room floor surface and at least 50mm above the top edge of any skirting board. This is to ensure that the air entering the appliance below the lower edge of the decorative trim is not restricted. If the appliance is fitted above a forward projecting hearth the base of the opening must be at least 50mm above the hearth. Again, this will ensure that the air entering the appliance below the lower edge of the decorative trim is not restricted.
- It is recommended that a non-combustible hearth extends a minimum of 300mm forward of the fire opening and a minimum of 150mm either side, and that a rise exist at the front edge and sides of the hearth of a minimum of 50mm.

PARAGON PANORAMA Installation Instructions

SECTION SEVEN APPLIANCE INSTALLATION Cont.

HOLE IN THE WALL INSTALLATION

Please read these instructions carefully if you intend an Installation without a hearth.

This appliance must be installed in accordance with all relevant sections of approved document “J” of the building regulations

The fire may be installed so that its base sits on a surface of a fire opening at least 105 mm up from the floor (*this is to ensure that no flame or incandescent material is less than 225mm above the floor, a requirement of approved document “J”*).

Consideration should be given to the location of the appliance ensuring it is very visible and it should be positioned at a height where it can clearly be seen on approach.

Where the fire is fitted as a “Hole in the Wall” without a hearth the installer **MUST** ensure the appliance is fixed firmly into the opening to ensure no movement takes place to the fuel bed when the appliance controls are operated.

The installer **MUST** ensure that the fuel bed is laid correctly and securely.

The installer **MUST** advise the user that care should be taken when the appliance is in use to ensure occupants **do not** get unnecessarily close to the appliance or position furniture or other appliances too close.

The installer **MUST** remind user of the requirement to fit a “secure fireguard” where the room is used by elderly, infirm or young persons.

The installer **MUST** explain to the user that the area immediately in front of the appliance must always be kept clear of combustible items other than the floor covering (which must be fixed).

PREPARING THE OPENING (existing masonry chimney breast)

Prepare opening as shown in to chimney
Ensure a smooth lead into the flue way, and that no combustible materials are used.

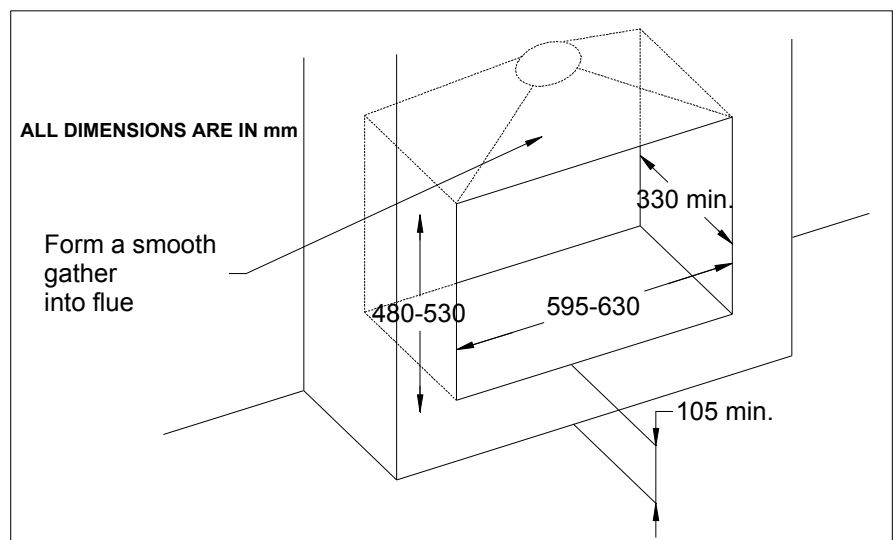

PARAGON PANORAMA Installation Instructions

SECTION SEVEN APPLIANCE INSTALLATION Cont.

CONNECTING THE GAS SUPPLY

Determine where the gas supply is to be connected to the appliance. This is best to be done via a concealed fitting from the rear. An isolation tap must be fitted.

If the supply is to be a concealed connection take into account the requirements of BS 6891 1998 dealing with enclosed pipes.

CHECKING GAS SOUNDNESS

Check for gas soundness in accordance with the current code of practice. (Refer to BS 6891 (in GB) or IS 813 (in IE)).

FIT BATTERY PACK (Packed with fuel bed)

Refer to Users Instructions Section Two for battery/shield installation instructions.

Important: - Refer to the 'Health & Safety Notice located on page 3 of this booklet before cleaning or replacing any refractory material.

Lay Twigs are shown earlier in this manual

ENSURE TWIG SHAPES PLACED AS INDICATED IN THESE INSTRUCTIONS.

PARAGON PANORAMA Installation Instructions

SECTION SEVEN APPLIANCE INSTALLATION Cont.

CHECKING FOR PRODUCT CLEARANCE

Check for satisfactory clearance of combustion products by inserting a lighted smoke match under the top edge of fire opening after the appliance as been burning 10 minutes. All the smoke must be drawn into the flue. Should spillage still occur, examine the chimney for the fault and rectify. The test should be carried out with all doors and windows closed. If an extractor fan is situated in the room this test should be repeated with the fan running. If there is a connected room with an extractor fan, the test should be repeated with all doors to that room opened and the extractor fan running.

Turn OFF the gas supply to the fire, remove the pressure gauge, and then turn the gas supply ON. Fit the fire front. Demonstrate the lighting and extinguishing procedures to the user.

Positioning Remote Control Eye

- Using the special self-adhesive clip attach the remote control eye to receiver bracket.
- Fit battery 9V battery (supplied) to remote hand set (see Section 2).
- Check that a signal is being received by pointing the remote control hand set in the direction of the appliance and simultaneously press the buttons marked '●' and 'standby'. Continue to hold in these two buttons until a 'bleep' is heard (approximately 2-3 sec.). If no sound is heard check position of remote control eye.

CHECKING OPERATION OF FIRE

- Remove decorative trim (position trim so that remote eye is visible when testing).
- Remove the screw from the pressure test point on the inlet elbow and fit pressure gauge.
- Turn on the gas to the appliance.
- Purge the air from the appliance by operating the appliance (see Section 2). The appliance will spark for approximately 20 second at which point if no ignition is detected the appliance will go to lock out and you must repeat the ignition procedure.
- Check that the electrode is sparking at the gap between the thermocouple tip and the electrode and that the pilot ignition is established. After approximately 20 seconds the main burner will light on the high setting.
- Check the inlet pressure is 20 ± 1 mbar for Natural Gas (G20).
- Refit pressure test point screw and check for leaks.
- Refit decorative trim.

ADVISE CUSTOMER THAT:

This appliance has a naked flame, as with all such fires it is recommended that a fireguard should be used for the protection of children, the elderly and infirm. Fireguards should conform to BS 6539 (1984) (Fireguards for use with solid fuel appliances).

The curing effect of heating the coals and other Refractory components will cause an initial odour. This is due to the starch used in the manufacturing process and is non-toxic.

Any debris should be cleaned from the appliance. A vacuum cleaner can be used but only after all the loose pebbles/driftwood have been removed. The appliance should be serviced annually by a competent person in accordance with these instructions and the appliance checked for spillage in accordance with the method detailed in these instructions.

HAND THESE INSTRUCTIONS OVER TO THE USER.

SECTION EIGHT MAINTENANCE

IMPORTANT: - REFER TO THE 'HEALTH & SAFETY NOTICE LOCATED ON PAGE 3 OF THIS BOOKLET BEFORE CLEANING OR REPLACING ANY REFRACTORY MATERIAL.

- Servicing should be carried out annually by a competent person such as a CORGI-registered person in accordance with the relevant regulations, to ensure the safe and correct operation of the appliance.
- Before commencing any service or replacement of parts, turn off the main gas supply. After servicing check for gas soundness.
- When ordering spare parts please quote appliance name and serial number, these can be found on the data badge, which is located on the flange behind the decorative fire trim.
- At least once a year, check for debris on the fuel bed and in the flue way.
- If excessive soot has accumulated check to establish cause, rectify and clean flue or chimney accordingly.
- Examine the fuel bed for signs of cracking and replace if necessary. (IMPORTANT) See fuel bed procedure earlier in this manual, before attempting to replace fuel bed components. The fuel bed should only be replaced as a complete set with no extra fuel bed parts should be added.

FUEL BED CLEANING

Important: - Refer to the 'Health & Safety Notice located on page 3 of this booklet before cleaning or replacing any refractory material.

The Twigs are delicate and they should be handled with great care. The loose Twigs may be removed for cleaning. They can be brushed very gently with a soft brush to remove dust or any deposits. A vacuum cleaner may only be used after the loose Twigs have been removed.

REPLACEMENT OF GAS CONTROL

1. Turn off the gas supply by the isolating cock.
2. Remove decorative trim.
3. Remove all loose fuel bed parts.
4. Remove moulded refractory parts.
5. Disconnect battery leads and remove appliance battery pack.
6. Disconnect the remote eye from bracket.
7. Remove 2 screws fixing burner unit into the casing.
8. Disconnect fire at inlet elbow and remove burner unit from the casing.
9. Disconnect the thermocouple from the rear of the gas valve.
10. Undo the three compression nuts securing the pipes to the gas valve and remove the two screws fixing the valve to the bracket.
11. Clean, service or replace gas valve.
12. Re-assemble in the reverse order.
13. Turn on the gas supply, check for soundness and re-commission appliance.

REPLACEMENT OF INJECTOR

1. Repeat operations 1-7 for removal of gas control.
2. Undo the two screws retaining the silencer bracket.
3. Lift away the silencer; noting its position the cut out slot pointing down, it must be put back in exactly the same orientation.
4. Unscrew the locking nut fixing injector to mounting bracket and silencer retaining bracket clean or replace as necessary.
5. Re-assemble the in reverse order and check assembly for gas soundness.
6. Turn on gas supply, check for gas soundness and re-commission appliance.

PARAGON PANORAMA Maintenance Instructions

SECTION NINE MAINTENANCE Cont.

REPLACEMENT OF CONTROL UNIT (EDB)

1. Repeat operations 1-7 for removal of gas control.
2. Disconnect leads from control unit and remove 4 bolts.
3. Re-assemble in the reverse order.

Turn on the gas supply, check for gas soundness and re-commission appliance

REPLACEMENT OF OXY-PILOT ASSEMBLY

NOTE: If the pilot assembly is replaced it must be replaced by an identical unit from the same manufacturer and replaced as a complete unit it is a NON SERVICABLE ITEM.

1. Repeat operations 1-5 for removal of gas control.
2. Disconnect the pipe from the gas control to the pilot burner
3. Disconnect the thermocouple connection from the rear of the gas control.
4. Remove ignition lead from pilot assembly.
5. Remove the two screws securing the oxy-pilot to the burner.
6. Before replacing ensure the code number for Oxy-Pilot replacement is suitable.
7. Re-assemble the in reverse order and check assembly for gas soundness.
8. Turn on the gas supply, check for gas soundness and re-commission appliance

SECTION TEN Wiring Diagram

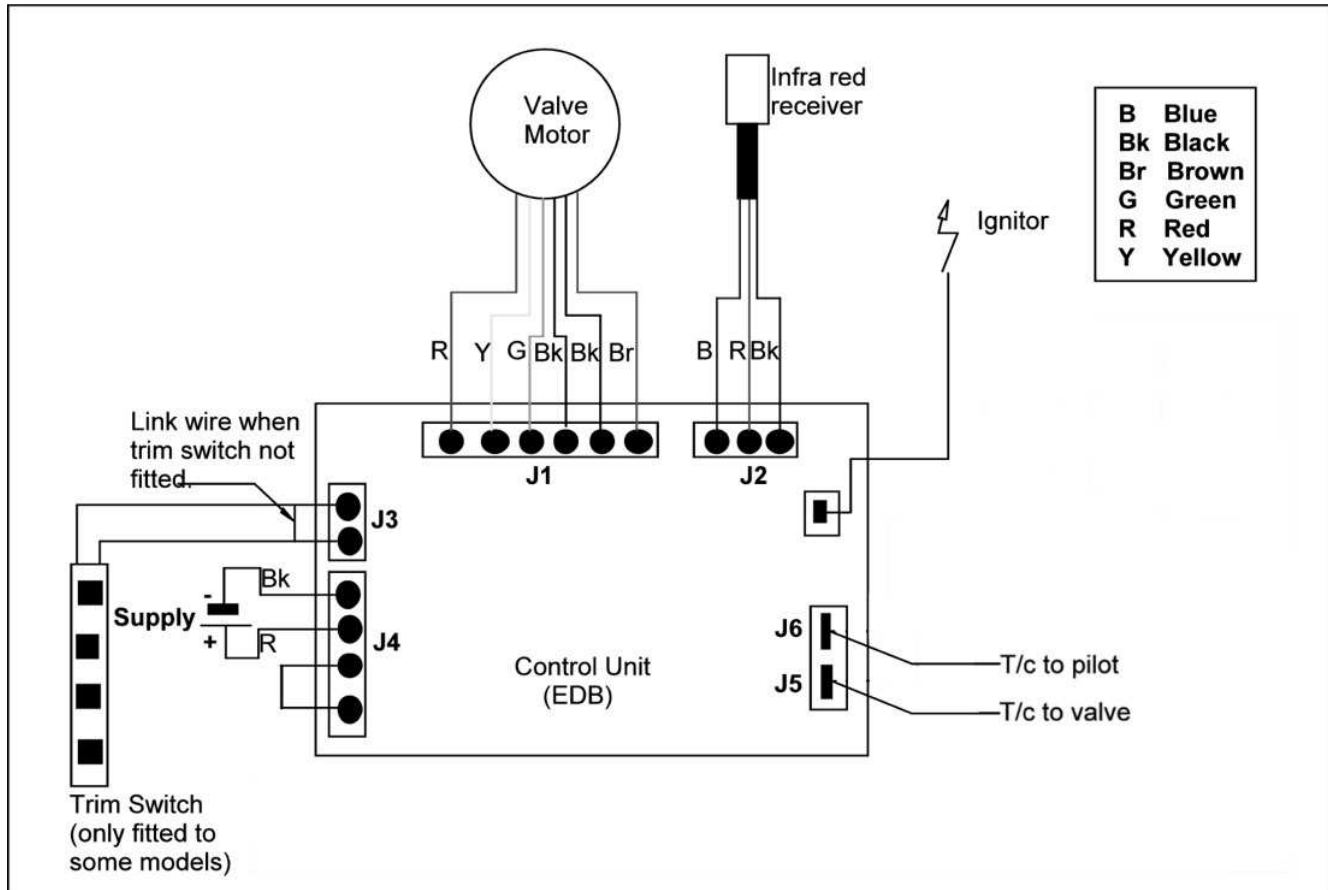

PARAGON PANORAMA

**THIS IS YOUR EXTENDED THREE YEAR PARTS
WARRANTY**

PLEASE READ IT CAREFULLY AND ENSURE YOUR INSTALLER HAS FILLED IN THE FIRST PORTION, KEEP IT IN A SAFE PLACE SO THAT IT IS AVAILABLE WHEN YOUR CORGI ENGINEER CARRIES OUT THE ANNUAL SERVICE.

THIS IN NO WAY REDUCES YOUR STATUTORY RIGHTS

THE WARRANTY COMMENCES FROM THE DATE OF PURCHASE YOU MUST RETAIN YOUR RECEIPT OR INVOICE AS PROOF OF PURCHASE.

THIS EXTENDED WARRANTY SPECIFICALLY EXCLUDES SOFT REFRACTORY COMPONENTS AND ANY BATTERIES.

Terms and Conditions

1. The appliance must be installed by a CORGI registered person.
2. The appliance must be used in accordance with the users instructions.
3. The appliance must be serviced annually by a CORGI registered person.
4. The service log must be correctly filled out and the record of annual services must be up to date and supported by receipts in each case.
5. This warranty is not transferable and relates to the original installation only.
6. The Registration Form must be correctly filled out and returned.
7. The appliance has not been subjected to misuse or accident or been modified or repaired by any person other than the authorised employee or authorised representative of Charlton and Jenrick Ltd.
8. The registration form must be returned within 3 months of purchase.

PARAGON HELPDESK NUMBER 01952 278 020

WARRANTY COVER

Important

For future reference we suggest you record the following details here, and keep the receipt as proof of purchase. This information may be asked for when you contact the helpdesk.

Model: **PARAGON PANORAMA**

Serial No.

--	--	--	--	--	--	--	--	--	--

This information can be found on the label attached to the packaging and on the data badge, which is located behind the appliance trim.

Retailer Name: _____

Address: _____

Date of Purchase:

--	--	--	--	--	--	--	--

Service Log

The following information must be complete and supported by receipts as part of the conditions of the extended three year parts warranty and the appliance must be registered by completing and returning the registration document (last page of this booklet) to Paragon Fires.

Date of First annual service:

--	--	--	--	--	--	--	--

Engineer Name _____

Corgi Registration No.

--	--	--	--	--	--	--	--	--	--

Date of Second annual service:

--	--	--	--	--	--	--	--

Engineer Name _____

Corgi Registration No.

--	--	--	--	--	--	--	--	--	--

We may introduce modifications to products from time to time, and consequently the details given in this booklet are subject to alteration without notice.

Paragon Fires

Telford

Shropshire

TF7 4QJ

Telephone 01952 278 020

Web Site www.paragonfires.co.uk

PLEASE REGISTER YOUR 12 MONTH WARRANTY WITH US TODAY

Simply detach this sheet from this booklet, complete and return it in a stamped addressed envelope to:

PARAGON FIRES

Charlton and Jenrick Ltd
UNIT G1 – G3
HALESFIELD 5
TELFORD
SHROPSHIRE
TF7 4QJ

YOUR DETAILS

Name _____

Address _____

Post Code

TELEPHONE No.

PRODUCT DETAILS

Model: **PARAGON PANORAMA** Serial No.

Date of Purchase

This information can be found on the label attached to the packaging and on the data badge, which is located behind the appliance trim.

WHERE DID YOU PURCHASE THIS PRODUCT

Name _____

Address _____

Post Code

TELEPHONE No.

Paragon Panorama Driftwood NG

Product ID Label	0833 Blk A0013	Serial No Prefix	FY
Fire Box Labels: Spillage (Text) Data Badge			
Burner Tray / Box Assembly			
Warning Label (Fire Guard)			
Cable Clip (Alum)			
Restrictor Elbow (male)			
Battery (9V PP3)			
Remote Control (Hand Set)			
Battery Holder with Lead			
Battery Insulation Blanket			
AA Battery (12)			
Base matrix (2396)			
Fuel Bed (Twig Set 4411)			
Owners Book			
ID Label & Packing Labels			
Serial Number			
Inspector			

Paragon Panorama Pebble NG

Product ID Label	0944 Blk A0012	Serial No Prefix	FY
Fire Box Labels: Spillage (Text) Data Badge			
Burner Tray / Box Assembly			
Warning Label (Fire Guard)			
Cable Clip (Alum)			
Restrictor Elbow (male)			
Battery (9V PP3)			
Remote Control (Hand Set)			
Battery Holder with Lead			
Battery Insulation Blanket			
AA Battery (12)			
Base matrix (4839)			
Fuel Bed (Pebble Set 4830)			
Owners Book			
ID Label & Packing Labels			
Serial Number			
Inspector			

Paragon Panorama Coal NG

Product ID Label	0943 Blk A0011	Serial No Prefix	FY
Fire Box Labels: Spillage (Text) Data Badge			
Burner Tray / Box Assembly			
Warning Label (Fire Guard)			
Cable Clip (Alum)			
Restrictor Elbow (male)			
Battery (9V PP3)			
Remote Control (Hand Set)			
Battery Holder with Lead			
Battery Insulation Blanket			
AA Battery (12)			
Base matrix (4839)			
Fuel Bed (Coal Set 4824)			
Owners Book			
ID Label & Packing Labels			
Serial Number			
Inspector			