



sargon 24, 30 & 35

Pre-Mix Condensing
Combination Boiler

Installation, Servicing
& User Instructions



Natural Gas

Heatline Sargon 24 / 30 / 35 Pre-mix Condensing Combination Boiler

British Gas Service Listing

SARGON 24	G.C.No. 47-157-15
SARGON 30	G.C.No. 47-157-16
SARGON 35	G.C.No. 47-157-17

Notified Body

IMQ	51BP2750	Directive 90/396/EEC
	51BP2751DR	Directive 92/42/EEC

The Heat Line™ range of heating boiler are manufactured from high quality materials, enabling reliability and optimum performance.

Heat Line™ are committed to the continual development of their appliances to ensure their customers benefit from the latest advances in combustion technology and energy savings.

The manufacturer, in the continuous process to improve his products, reserves the right to modify the data expressed in the present documentation at any time and without prior notice.

The present documentation is an informative support and it cannot be considered as a contract towards third parties.



'Benchmark' Log Book, Boiler Registration & SEDBUK

As part of the industry-wide initiative the boiler comes complete with an Installation, Commissioning and Service Record Log Book. Please read the Log book carefully and in accordance with current legislation complete all sections relevant to the appliance and installation. The details within the Log Book will be required in the event of any warranty work.

On completion the Log Book, which is found on pages 57&58 of the Installation manual, must be left with the end user and the relevant sections completed on each subsequent Service visit.

NOTE: You are also obliged to register the installation of this boiler with C.O.R.G.I. Should you wish to check the SEDBUK website for the rating of this boiler search under DD HEATING or the boiler name and designation, e.g. SARGON 24.

Contents

Section	Page
Preface	
1. Installation Regulations	4
2. Technical Data	5
3. Boiler Characteristics	7
4. Operation	8
5. General Installation	8
6. Appliance Sitting	12
7. Flue Terminal Location	13
8. Flue (General)	13
9. Electrical Connections	16
Wiring Diagram	17
10. Boiler Installation	18
11. Gas Supply	22
12. Filling the System	22
13. Control Panel Functions	23
14. Commissioning	26
15. Onboard Adjustments	27
16. Safety Devices	29
17. Routine Servicing	30
18. Component Replacement	33
19. Gas Type Conversion	44
20. Fault Finding Chart	45
Appendices	
Appendix 1. Spare Parts List	48
Appendix 2. User Instructions	49
Appendix 3. Benchmark Logbook	57-58

Preface

The Heat Line™ Gas fired combination boiler meets the requirements of Statutory Instrument 'The Boiler (Efficiency) Regulations' and is deemed to meet the requirements of:

- Gas Appliance Directive 90/396/EEC
- Efficiency Directive 92/42/EEC
- Low Voltage Directive 73/23 EEC (modified from 93/68) and;
- Electromagnetic Compatibility Directive 89/396 EEC (modified from 93/68)

Heat Line™ declares that the materials used in the manufacturer of this appliance are non-hazardous and that no substances harmful to health are contained within the appliance.

Warnings

Heat Line™ accepts no responsibility for the unsatisfactory performance of the appliance or flue arising from the failure to comply with the installation and user instructions. Incorrect installation could invalidate your guarantee and may lead to prosecution.

If the appliance is re-sold or installation transferred the appliance must be re-registered with Heatline in order to maintain the warranty.

The boiler must be installed in accordance with these instructions and the regulations currently in force. Read these instructions carefully before installing or using the appliance.

Manual Handling: When manoeuvring the boiler always use safe techniques – keep your back straight, bend your knees, don't twist, move your feet. Avoid bending forwards or sideways and keep the load as close to your body as possible. Where possible transport the boiler using a suitable trolley, sack truck or get some assistance. Grip the boiler firmly and before lifting establish where the weight is concentrated to determine the centre of gravity, repositioning yourself if necessary.

The Signs on Box



The sign of approval.



This is a fragile piece of equipment: Do not drop.



The packed appliances may be stacked three high.



Do not crush the packaging as this may damage the appliance.



Store the appliance upright as indicated on the box.

Access, warnings and connections on the boiler



Low Voltage Room Thermostat: This picture shows the terminal block, which is located at the bottom left hand side of the control panel cover, to which the room thermostat must be fitted.

NOTE: This is a voltage free connection and no mains power must be applied to these terminals. For mains powered thermostat connection, see section 9.5.

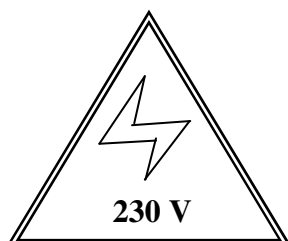

Warning High Voltage! This sign is located on the back of the control box housing warning of high voltages within the control box. Turn off and isolate the appliance before removing this cover.

NOTE: Take care as there may be residual voltage within some components.

1. Installation Regulations

- 1.1. This appliance must be installed in accordance with the Rules in Force by a competent person or registered C.O.R.G.I. engineer in accordance with the Gas Safety (Installation and Use) Regulations. Failure to install this appliance correctly may invalidate your guarantee.
- 1.2. Your C.O.R.G.I. registered engineer should carry a C.O.R.G.I. ID card containing their registration number, which should be recorded in your BENCHMARK Log Book, which is supplied within the Instructions. You can check the validity of this ID number by contacting C.O.R.G.I. on 0870 401 2300.
- 1.3. This appliance must be installed in accordance with the Gas (Safety and Use) Regulations, current Building Regulations, Building Standards (Scotland), I.S.813 Installation of Gas Appliances (Ireland), IEE Wiring Regulations (BS 7671), Health and Safety Document No. 635 (Electricity at Work Regulations) and Local Water Authority Bye Laws.
- 1.4. On installation the following British Standards must also be considered:
 - ✓ BS 6798 Specification for installation of gas fired hot water boilers of rated input not exceeding 70kW.
 - ✓ BS 5449 Central heating for Domestic Premises.
 - ✓ BS 5546 Installation of gas hot water supplies for domestic purposes.
 - ✓ BS 5440 Flues and Ventilation for gas appliances of rated input not exceeding 70kW (Part 1 Flues)
 - ✓ BS 5440 Flues and Ventilation for gas appliances of rated input not exceeding 70kW (Part 2 Air Supply)
 - ✓ BS 6891 Installation of low pressure gas pipe-work installations up to 35mm (RI).
- 1.5. Due to the manufacturer's continuous improvement policy the manufacturer reserves the right to change any specification of the appliance or make modifications to these instructions, which meet current regulations at the time of print. However, the instructions must not be taken as overriding statutory requirements.
- 1.6. To ensure reliability and continued performance ensure that other components in the system are also approved to relevant standards and that the appliance and system is adequately protected and maintained on an annual basis.

For further information or advice contact Heatline™ Service & Technical Enquiries in UK & IE on:

Service:	0870 777 8341
Spares:	0870 777 8402
Technical Help Line:	0870 777 8318
E-mail via our web site:	www.heatline.co.uk .

2. Technical Data

SARGON		24	30	35
Gas Category		II 2 H 3+		
Gas inlet pressure G20	mbar	20	20	20
Gas inlet pressure Butane / Propane	mbar	28-30/37	28-30/37	28-30/37
Heat Input (Q _{max}) (CH)	kW	20.0	25	30.5
Heat Output (P _{max}) (CH)	kW	19.5	24.4	29.8
Heat Input (Q _{max}) (DHW)	kW	24.0	31.5	35.8
Heat Output (P _{max}) (DHW)	kW	23.3	30	35
Heat Input (Q _{min}) (CH/DHW)	kW	10.5	11.0	11.0
Heat Output (P _{min}) (CH/DHW)	kW	10.1	10.6	10.6
Useful efficiency at 100% load	%	97.5	97.5	97.6
Useful efficiency at 30% load	%	107.0	107.0	106.9
Gas Rate (Max) (NG)	m ³ /h	2.12	2.54	3.18
Gas Rate (Max) (Butane)	kg/h	1.57	1.97	2.4
Gas Rate (Min) (NG)	m ³ /h	1.11	1.16	1.16
Gas Rate (Min) (Butane)	kg/h	0.83	0.867	0.867
Power supply	Input	230 V, 50 Hz		
Gas Diaphragm (NG)	mm	7.1	7.0	7.0
Gas Diaphragm (LPG)	mm	4.9	5.0	4.9
Air Diaphragm (NG)	colour	Red	Red	Red
Air Diaphragm (LPG)	colour	Red	Red	Red
Max. power consumption	Watts	175	175	175
Level of protection		IPX4D		
Maximum heating temperature	°C	84~85		
Max. domestic hot water temperature	°C	60		
Operating pressure PMS / Min	Bar	8 / 0.5		
Domestic water supply pressure PMS / Min	Bar	10 / 0.8		
Domestic Water Supply Output (litres/min.)	35 °C	9.83	12.29	14.34
	30 °C	11.47	14.34	16.73
	25 °C	13.76	17.20	20.07
Expansion Vessel Capacity	litres	7		
Expansion Vessel Pre-charge	bar	0.5		
Air Intake Pipe Diameter	mm	100		
Flue Pipe Diameter	mm	60/100 concentric & 80/80 _{Twin}		
CO ₂ % at nom ±0.1% (NG)	%	9.8	9.5	9.9
CO ₂ % at nom ±0.1% (Butane)	%	10.4	11.0	10.8
CO ₂ % at min. ±0.1% (NG)	%	10.0	10.0	10.0
CO ₂ % at min. ±0.1% (Butane)	%	10.3	10.9	10.8
Output mass (NG)	g/sec	8.77	11.17	12.94
Output mass (Butane)	g/sec	8.76	10.69	12.70
Nitrogen oxide (NO _x) emissions at max. heat input	NO _x Class	5	5	5
Nitrogen oxide (NO _x) emissions at max. hot water input	NO _x Class	5	5	5
Combustion products temperature (max.)	°C	75	71	71
Case Dimensions	mm	330(d) x 430(w) x 720(h)		
Shipping weight	kg	38	39	40
Dry weight	kg	41	42	43

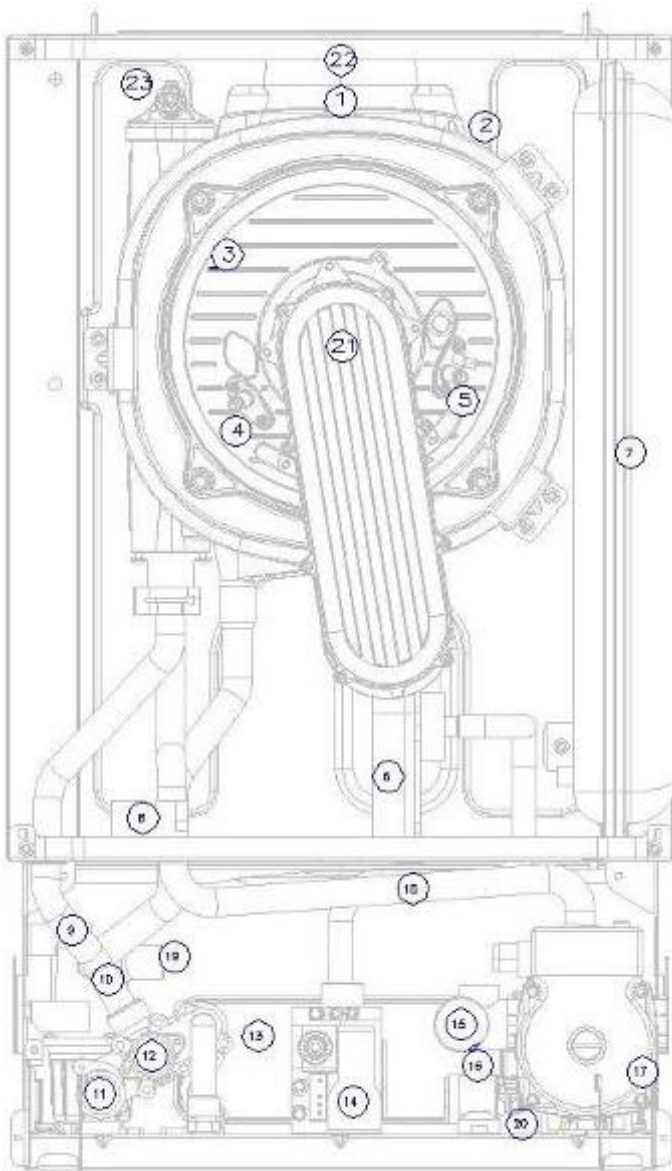

Key

- 1 - Flue Sensor
- 2 - Thermal Fuse
- 3 - Heat Exchanger
- 4 - Ionisation Electrode
- 5 - Ignition Electrode
- 6 - Fan Group (Fan, Air gas mixer, ring)
- 7 - Expansion Vessel
- 8 - Ignition Transformer
- 9 - Overheat Safety Thermostat
- 10 - Central Heating Temperature Sensor (Flow)
- 11 - Pressure Relief Valve
- 12 - Diverter Valve
- 13 - Secondary Heat Exchanger
- 14 - Gas Valve
- 15 - Pressure Sensor
- 16 - Return Hydroblock
- 17 - Pump
- 18 - Central Heating Temperature Sensor (Returr)
- 19 - Condensing Trap
- 20 - D.H.W. Flow Sensor
- 21 - Burner
- 22 - Plastic Flue Channel
- 23 - Automatic air vent
- 24 - D.H.W. Temperature Sensor

Figure 1

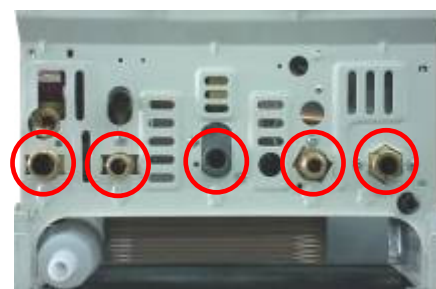

A B C D E

		Valves
A - Heating Flow	(22mm)	Red
B - D.H.W. Outlet	(15mm)	No Valve
C - Gas Inlet	(22mm)	Yellow
D - Cold Water Inlet	(15mm)	Blue
E - Heating Return	(22mm)	Blue (with filter)

3. Boiler Characteristics

3.1 The Sargon 24 / 30 / 35 are fan flued, wall-mounted combination boilers that supply both central heating and mains fed domestic hot water. Being room sealed the boiler may be installed in any room without the need for purpose made ventilation. However, if the boiler is installed in a compartment it is recommended that the compartment is ventilated for cooling purposes. A functional diagram of the boiler's principal components is given in *figure 1*.

3.2 An electronic control unit, consisting of a PCB and separate ignition module provides direct burner ignition and flame supervision along with continuous modulation of the burner's gas supply.

3.3 An interface unit, which includes boiler adjustment potentiometers and fault display provides easy adjustment and fault diagnosis.

3.4 Heat transfer of heat to the boiler's primary hydraulic circuit is obtained via a primary, gas to water heat exchanger within a hermetically sealed combustion chamber. A 24 volt, modulated speed fan blows the gas/air mixture into the combustion chamber and expels the products of combustion to outside air via an associated flue system.

3.5 A secondary heat exchanger allows the instantaneous transferral of heat from the primary hydraulic circuit to water destined for domestic hot water use. The secondary heat exchanger is sized so as to minimise thermal shock and is protected against the build up of lime scale by limiting the D.H.W. outlet water temperature to a maximum of 60°C.

3.6 An integral pump located in the boilers main hydraulic circuit circulates water through the primary heat exchanger to either the central heating circuit or D.H.W. heat exchanger, depending on the demand. In the event of reduced or interrupted water circulation in the central heating circuit, an automatic system by-pass should be fitted as far away from the boiler as possible. Note: It is no longer permissible to utilise a non-thermostatic controlled radiator as a by-pass.

3.7 Room temperature can be controlled by the use of an external room thermostat or thermostatic radiator valves. Note connection of the room thermostat is dependant on the operating voltage of the thermostat. See section 9.4 & 9.5 for details.

3.8 The boiler incorporates an integrated clock, which allows the setting of central heating periods (See the User Instructions, Boiler Controls for details) and the boiler's control panel incorporates an LCD display, which indicates the state of operation and fault defect codes.

4. Operation

4.1 Using the operating switch the boiler can be set to operate either on domestic hot water only or domestic hot water and heating.

Note: Domestic hot water demand draws preference over heating. During heating periods the boiler will automatically revert back to heating mode, after a draw off of hot water, but there will be a 45sec delay if the No.S3 dipswitch is set to the OFF position. See figure 19.

4.2 Depending on demand water is either diverted via the diverter valve to the secondary water-to-water heat exchanger for domestic hot water or directly to the heating system.

4.3 DOMESTIC HEATING MODE:

- When the Control is set to “Winter” mode and a heating demand is requested, (power is on, the timer and thermostat are calling for heat) the boiler will fire automatically. The integral pump is then energised and hot water from the boilers primary circuit is circulated around the central heating systems pipe-work and radiators. When the demand for central heating is no longer present, either the thermostat reaches temperature or the time clock reaches the end of its set period, the burner will shut down and the boiler will revert to stand-by, waiting to respond to the next heating or hot water demand. The pump will continue to operate for a short period of time to dissipate any excess heat from within the boiler’s heat-exchanger. If during the heating period there is a call for hot water this will take preference over heating. When satisfied, the boiler will then supply the heating demand as required. Note there will be a delay of 45sec delay depending on how the boilers dipswitches are set. See section 15.3 for details.

4.4 DOMESTIC HOT WATER MODE:

- When the Control is set to either the “Summer” or “Winter” mode and there is a request for hot water (a hot water faucet is opened) the boiler will fire automatically. The integral pump is then energised and hot water from the boilers primary circuit is circulated around the water to water heat-exchanger, irrespective to any demand for heating, giving up its heat to the domestic hot water. When the faucet is closed the pump will continue to operate for a short period of time to dissipate any excess heat within the boiler’s heat-exchanger into the heating circuit and after a 45sec delay will revert back to the heating mode if required.

5. General Installation

5.1 Installer Testing & Commissioning Tips

- The installer shall instruct the user in the operation of the boiler, safety devices contained within the boiler and instruction on **the location of the filling loop and how to re-pressurise the system if the water pressure falls**. The installer should then hand over the instructions indicating the included Benchmark Logbook that has been completed.

- The user should be instructed to keep the instructions in a safe place for servicing and future reference.
- It is important to keep the boiler clear of dust during the installation. In particular, do not allow debris to enter the top of the boiler where the flue connection is made.
- Before you fit the boiler ensure that the pipe work that you are installing is connected to the appropriate connections on the boiler i.e. cold water pipe to cold water inlet, hot water outlet to the hot water tap etc. See Figure 1 for detail.
- Please ensure that you spin the pump rotor manually before firing the boiler.
- **Remember to thoroughly flush the water circuits, after isolating the boiler, in order to remove any fluxes and debris from them. This should be done particularly where boilers are being fitted to existing radiator circuits.**
- **Refer to BS 7593:2006 for the details to clean DHW and Central heating system.**
- **This boiler has been factory set but adjustment may be required to the Heating input in order to match the heating demand. This can be done using potentiometer R29. See section 15 for details.**
- To ensure that air is vented from the pump and heat exchanger as the system fills, release the small vent caps (1 turn) of the air vents, which are located on top of the pump and at the top left hand side of the heat exchanger before filling.
- **Do not use the pressure relief valve as a means of flushing the system,** please use the valve below the pump. Discharging water from the system from the pressure relief valve may allow debris to collect on the seating allowing water to weep after you have left the job causing the boiler to lose pressure and shut down.
- The boiler is fitted with inlet filters both on the cold water inlet and the central heating return. If you are unable to obtain hot water at the tap it is likely that the cold water inlet valve filter has become blocked, whilst blockage of the filter on central heating return valve will cause the heater to lock out at the overheat thermostat as the water flow is reduced.
- If you are able to obtain hot water but not heating it is also advisable to check the clock connections and that the room thermostat and time clock are calling for heat.
- Remember that after hot water draw off there is a 45 sec delay before the heating will fire up if No.S3 dipswitch is in the OFF position, *see fig 22*.
- When commissioning the boiler check the gas inlet pressure is 20mbar (NG) or 37mbar for LPG.
- Note an anti-cycle delay time can be set up to a maximum of 255 seconds by adjusting potentiometer R28 as described in section 15.1.

If you experience any problems please refer to the installation and commissioning guidelines within the boiler instruction manual. If necessary, please contact Heat Line™ Service Enquiries in the UK on 0870 777 8341, for further advice or technical assistance on **0870 777 8318**.

NOTE – FOR INSTALLERS:

REMEMBER IT IS A REQUIREMENT TO COMPLETE THE BENCHMARK CODE OF PRACTICE LOGBOOK BEFORE LEAVING THE INSTALLATION. YOU ARE ALSO REQUIRED TO REGISTER THE INSTALLATION WITH C.O.R.G.I. OR YOUR LOCAL AUTHORITY.

5.2 The boiler is designed to operate on fully pumped, pressurised sealed systems operating at a maximum of 3bar pressure and maximum design flow temperature of 85°C.

5.3 The boiler's integral expansion vessel is pre-charged to a pressure of 0.5bar and will accommodate a system volume of 125l at an average water temperature of 75°C and maximum system pressure of 3bar. If the system volume is more than 125l an additional expansion vessel must be fitted to suit the size of the system. A typical installation of an additional pressure vessel is shown below in *figure 2* below.

NOTE: The filter valve must be fitted to the boiler return at the right of the boiler.

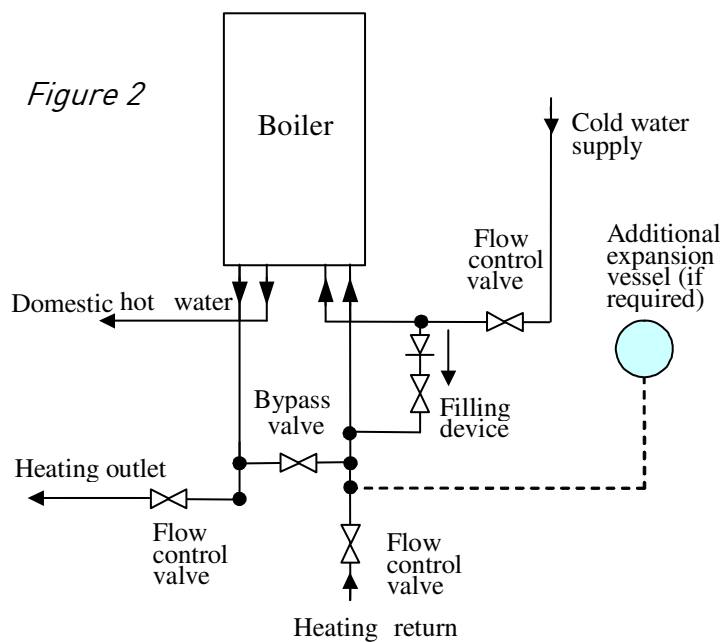

5.4 The heating circuit should be designed and balanced to give a 20°C temperature rise across the boiler flow and return.

5.5 When fitting a new boiler to an existing system the system must be thoroughly flushed in accordance with the recommendations of BS7593:2006 prior to installation.

NOTE: also that the gas supply pipe to the boiler from the meter should be in 22mm copper.

5.6 It is recommended that the system should be protected by a proprietary anticorrosion inhibitor.

5.7 On installation it is important to ensure that the heat exchanger is not a natural collecting point for air and where possible, the system pipe work should have a gradient to ensure any excess air is carried naturally to other purpose made, air release points.

5.8 The system's water must always be allowed to circulate whenever the circulation pump is running. An automatic by-pass must be provided.

NOTE – It is no longer permissible to use non-thermostatic radiator valves to allow by-pass through a radiator.

5.9 In high water volume systems or under floor heating systems, see section 15.2, where prolonged operation of the boiler is expected at temperatures below 60°C, a by-pass must be installed on the boiler outlet in order to prevent condensation forming inside the boiler body. Failure to comply with this requirement will invalidate the manufacturer's guarantee.

5.10 The pressure relief discharge must be directed away from any electrical equipment or where it could cause a hazardous situation.

5.11 In order to drain the complete system efficiently it is recommended that drain cocks (compliant to BS2879) are fitted at the lowest points in the system pipe-work.

5.12 To obtain the best hot water performance from your boiler it is suggested that the cold water supply to the boiler is the first draw off from the incoming mains supply.

NOTE: The boiler will not operate on DHW unless there is a minimum pressure of 0.25bar with a flow rate of 2.5l/min. Where inlet pressures exceed 10bar, a pressure regulator must be fitted to the cold water supply.

5.13 Where cold water mains are fitted with a water meter, check valve(s) or loose jumper stopcock, you may need to fit a domestic hot water mini-expansion vessel in order to avoid water hammer.

5.14 To obtain the best hot water performance from your boiler it is suggested that supplies to taps are run in 15mm copper, as short as possible and where practical, be insulated to reduce heat loss.

5.15 The boiler incorporates a frost protection thermostat. Therefore if the boiler will not be used for long periods of time during cold weather, in order to avoid freezing the electric supply must be left ON and all the central heating isolation valves must be left open. The internal frost thermostat will then operate the boiler if the temperature falls too low. However, if the electrical supply is to be turned off the boiler, the heating system and domestic hot water circuit must be drained.

6. Appliance Sitting

6.1 If the boiler is to be installed in any room or compartment, it does not require any purpose made ventilation for combustion air. If sited in a room containing a bath or shower then particular reference is drawn to the current I.E.E. Wiring Regulations, local Building Regulations or any other local regulations currently in service.

6.2 The boiler is not suitable for external installation unless protected by a purpose made building such as a boiler house.

6.3. The following clearances are recommended for installation purposes; 200mm above, 300mm below and 20mm at each side. 600mm is required at the front but this may be upon opening a cupboard door.

6.4 Flammable fluids and materials must be stored at least 1m away from the boiler.

6.5 The wall on which the boiler is mounted must be sufficiently strong to support the weight of the boiler.

6.6 A corrosion resistant or plastic condensate drain pipe must be fitted to allow discharge of condensate to a drain or soak way.

Where possible condensate should be discharged into the household internal drainage system. If this is not practical, discharge can be made into an external drain. If neither of the above options are possible then condensate must be discharged into a purpose designed soak way.

NOTE: It is recommended that any external condensate pipe is insulated and increased to 32mm diameter in order to prevent the condensate from freezing.

6.7 For compartment installation the requirements of BS6798 and BS5440: Part 2 must be met.

- The compartment must be of sufficient size to permit access for inspection and servicing or the removal of the boiler and any ancillary equipment.
- Any space used for airing clothes or storage must be separated from the appliance by a non-combustible partition. Where the partition is formed from perforated material, then the major dimension of the apertures shall not exceed 13mm.
- No combustible surface must be within 20mm of the boiler casing without protection.
- There must be 20mm clearance between the compartment door and boiler case.
- Where the boiler's flue pipe passes through the airing space, it must be protected by a non-combustible sleeve or fire stop having a minimum clearance of 20 mm between the flue pipe and sleeve. In addition, if the flue pipe passes through the partition then the clearance gap of the flue pipe or its guard with the partition must not exceed 13 mm.

6.8 When the boiler is intended for use with LPG it must not be installed in a room or internal space below ground level.

7. Flue Terminal Location

7.1 The flue terminal must be sited with minimum clearances as specified in *Figure 3*. Note if plumbing becomes problematic or causes a nuisance a plume management kit is available from your stockist.

7.2 Current regulations and standards require a terminal guard to be fitted where the terminal is accessible to touch or at risk of being damaged. All wall mounted terminals sited within 2m of the level which people have normal access, should be adequately protected with a suitably sited guard

7.3 Where the flue terminates within 1m of a plastic or painted gutter or within 500mm of painted eaves then protection should be provided in the form of an aluminium shield at least 1m in length, fitted to the underside of the gutter or painted surface.

7.4 The flue should not be sited where the condensate “plume” may give rise to a nuisance factor under certain weather conditions.

NOTE: If you have difficulty siting the flue in an appropriate location your supplier will be happy to supply a “anti-plume management kit”, which discharges the flue products at a higher level.

8. Flue (General)

8.1 The boiler utilises a concentric flue arrangement, which consists of a 60mm-diameter inner flue and 100mm-diameter outer air inlet duct, which comes in either horizontal or vertical arrangements. However, for greater flexibility flues are available as 80/80mm twin pipes and in circumstances where the plume may cause a nuisance horizontal and vertical anti plume kits available. NOTE: Only use approved Heatline flue products with this boiler, which can be sourced from the supplier of your boiler or Heatline stockist.

8.2. The standard 705+/-5mm flue (*figure 4*) is not supplied with the boiler and should be purchased separately from your supplier. This flue may be routed to the rear, left or right of the appliance by means of the 90° degree bend, which is supplied in the flue kit (*figure 5*). The bend is connected to the boiler using the screws provided and sealed with the gasket.



Figure 5

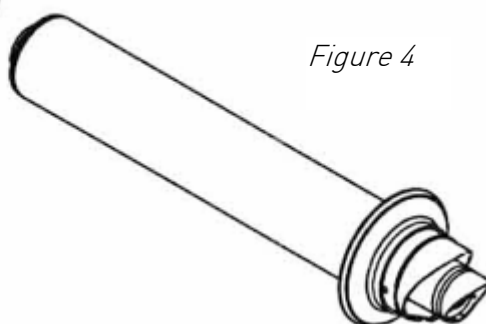

Figure 4

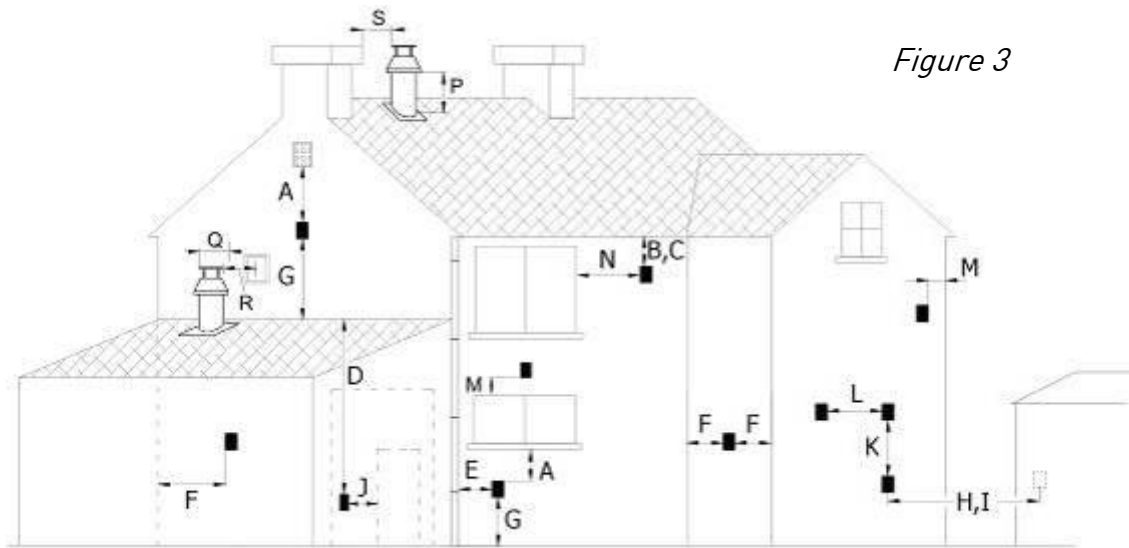
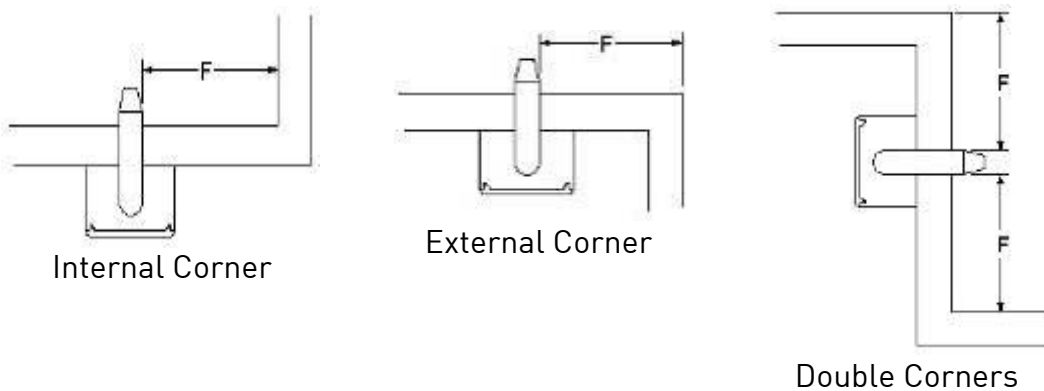

Figure 3



TERMINAL POSITION		MINIMUM DISTANCE
A-	Directly below an openable window or other opening e.g. air brick	300 mm
B-	Below gutters, soil pipes or drain pipes	75 mm
C-	Below eaves	200 mm
D-	Below balconies or car front roofs	200 mm
E-	From vertical drain pipes and soil pipes	150 mm
F-	From internal or external corners	300 mm
G-	Above ground, roof or balcony level	300 mm
H-	From a surface facing a terminal	600 mm
I-	From a terminal discharging towards another terminal	1200 mm
J-	From an opening in a car port (e.g. door, window) into a dwelling	1200 mm
K-	Vertically from a terminal on the same wall	1500 mm
L-	Horizontally from a terminal on the same wall	300 mm
M-	Above an opening, air brick, opening windows, etc.	300 mm
N-	Horizontally to an opening, air brick, opening windows, etc.	300 mm
P-	Above roof level (to base of terminal)	300 mm
Q-	From adjacent wall to flue	300 mm
R-	From an adjacent opening window	1000 mm
S-	From another roof terminal	600 mm
	From an external boundary. Note if the terminal is facing a boundary it is recommended that an anti-plume kit be fitted.	600 mm
	Installation type C5 the terminal for the supply of combustion air and for the evacuation of combustion products shall not be installed on opposite walls of the building.	

8.3. The 60/100mm horizontal flue system may be extended up to a maximum of 5.0m, excluding the initial 90° bend, using additional spare components available from the supplier of your boiler or Heatline stockist. Please note only use approved Heatline flue products with this boiler. (Flue type: C13 – C33 – C43 – C53)

8.4. A vertical 60/100mm flue kit is also available (*figures 6*), which can be extended up to a maximum of 5.0m, excluding the initial boiler connection, using additional components available from the supplier of your boiler or Heatline stockist. Please note the terminal is suitable for a flat or pitched roof and only approved Heatline flue products can be used with this boiler. The connection of the vertical flue system is similar to the Horizontal flue connection. The system is connected with screws to the boiler and the vertical extension pipes and roof terminal are connected by clips.

8.5. The 80/80mm twin flue pipe system may be extended up to a maximum of 20m in any combination of horizontal or vertical configuration using additional spare components available from your boiler supplier or Heatline stockist. **NOTE: When such a system is used it is necessary to have all joints accessible for inspection.**

8.6. The anti-plume kit comprises of a 710mm horizontal section with elbow to connect the 1m vertical condensing tube, which has a horizontal or vertical terminal dependant on your requirements. The maximum length of horizontal flue including the terminal but excluding the initial elbow from the boiler and 1m vertical condensing tube is 4m.

NOTE. For each additional 90° elbow used the maximum flue length must be reduced by 1.5 m, whilst the use of 2 x 45° bends warrants a reduction of 2m.

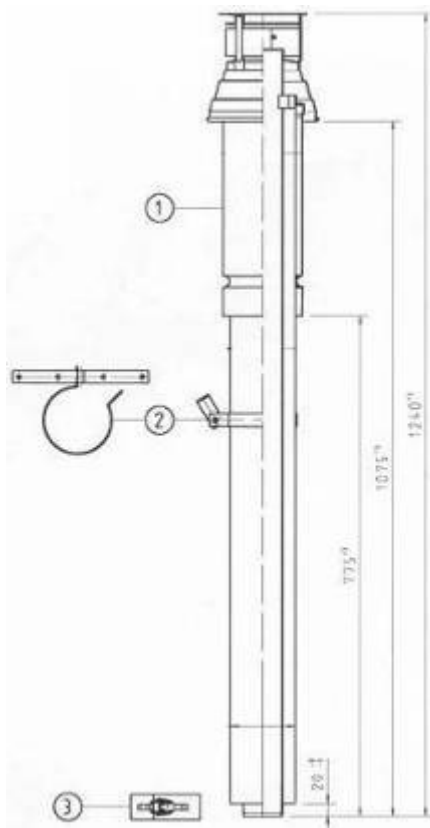

Figure 6

WARNING !

ONLY A HEATLINE APPROVED FLUE IS TO BE USED WITH THIS PRODUCT. FAILURE TO COMPLY WITH THIS REQUIREMENT WILL INVALIDATE YOUR GUARANTEE AND MAY LEAD TO A DANGEROUS SITUATION.

9. Electrical Connections

9.1 The boiler is supplied factory wired complete with 1.5 m of mains fly lead. All electrical connections to the mains supply must be made in full accordance with the current I.E.E. or other local regulations.

9.2 The boiler must be connected to an effective earth system. Using the cable supplied the boiler may be connected via a 3 amp fused three pin plug to an unswitched shuttered socket outlet. However if the boiler is installed in a room containing a bath or shower regulations dictate that disconnection must be incorporated in the fixed wiring with a switch provided for disconnection from the mains supply having a contact separation of at least 3 mm on all poles and fused at 3 amp.

9.3 The point of connection must be readily accessible, at a distance no further than 1.5m adjacent to the appliance and provide complete electrical isolation for the boiler and control system.

9.4 The low voltage room thermostat terminal block is located behind the plastic cover on the left hand side (*figure 7*). On connection of a voltage free room thermostat to the boiler, the factory fitted bridge across the room thermostat terminal connectors must be removed. If a mains voltage thermostat is to be used then please refer to 9.5 below and the electric wiring diagram in *figure 8*.

9.5 Mains powered thermostats must be connected directly to the mains circuit board as indicated in *Figure 8* where connection of the thermostat is to the terminal block within the control box. If using this connection the link wire across the terminal block shown in figure 7 **must be removed**.

9.6 Ensure that the polarity of the mains connection is correct as reversed polarity may cause the appliance to malfunction.

9.7 While the boiler's main pcb, pump, three-way valve and gas valve are supplied at 230V a.c., all other components and associated circuits are supplied at low voltage.

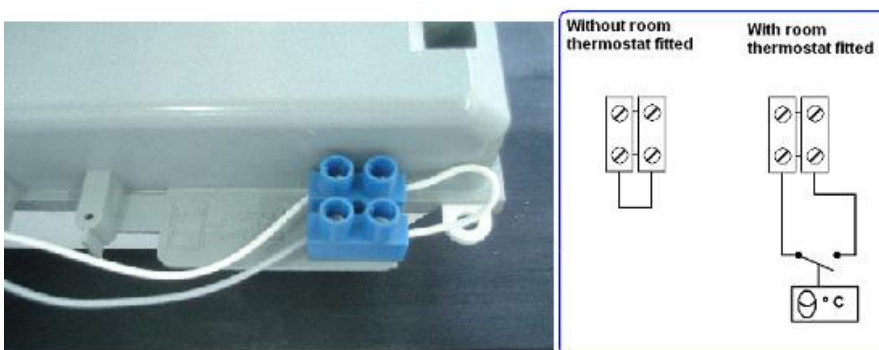

Figure 7

Warning: On no account must any mains voltage be applied to any of the terminals on the heating control connection plug.

9.8 On connecting the mains electrical supply to the boiler, it is essential to ensure that electrical safety checks for earth continuity, earth resistance, polarity and short circuit are carried out prior to making the final connection. A diagram of the boiler's electrical circuit is given as *figure 8*.

Fuse ratings: 2AT

Figure 8

Open Therm / On Off
Low Voltage Room
Thermostat

Mains powered
thermostat connection

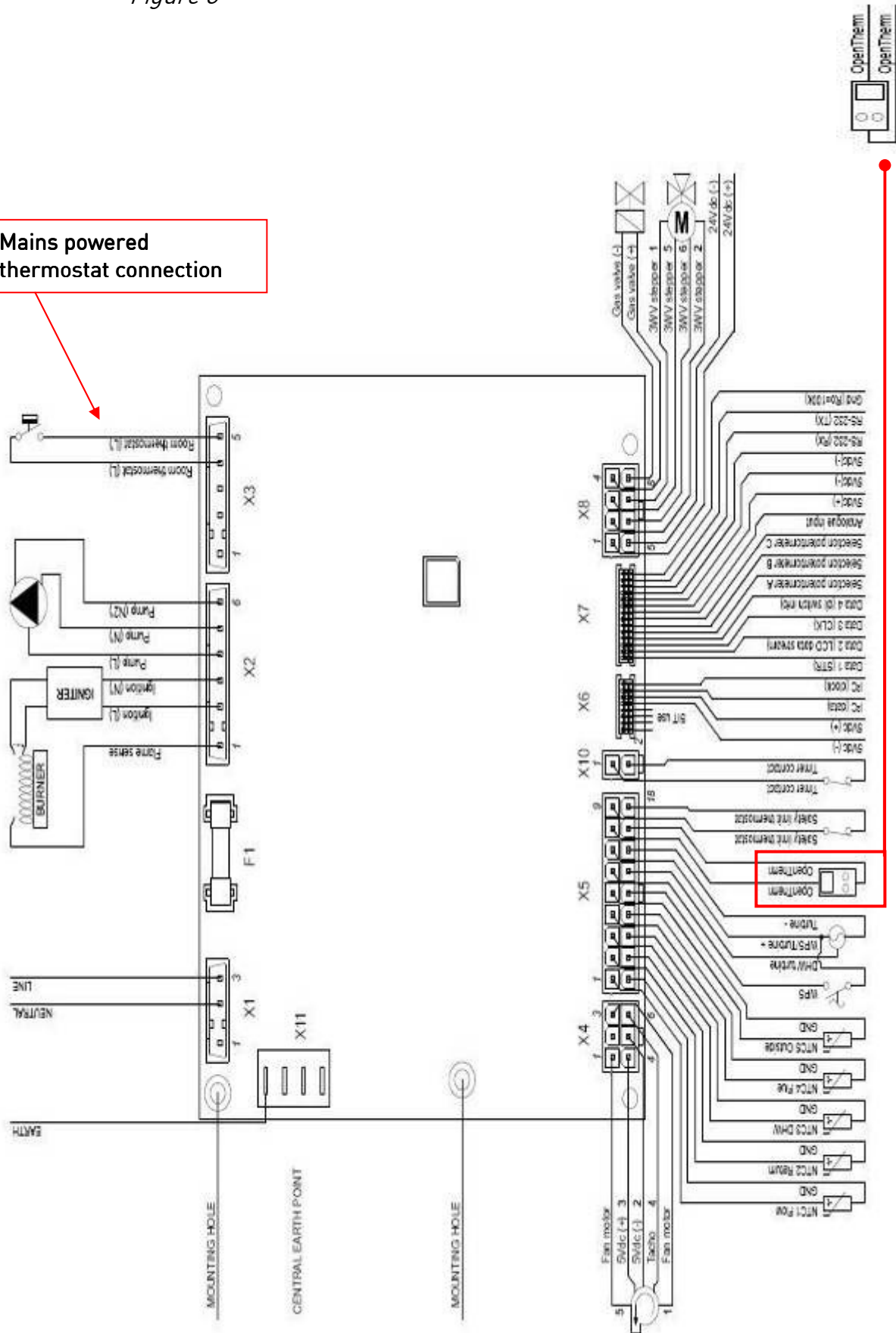

10. Boiler Installation

10.1 Prior to installing the boiler check the contents of the carton: Appliance, Valves, Wall Hanging Bracket, Mounting Template Service, Installation and User Manual, which includes the Benchmark Log Book and Guarantee Card. The boiler dimensions are given in *figure 10*.

10.2 Ensure that the boiler is suitable for the gas supply by checking the data plate, which is situated on the inside of the control panel door, and that the system and chosen boiler position is in accordance to Sections 5, 6 and 7 of these instructions.

10.3 Position the supplied template on the wall, ensuring it is level both vertically and horizontally (*figure 10*). Mark the boiler wall bracket fixing positions and flue outlet position (rear flue only). For flue side exit from the boiler - Mark the horizontal flue centre line on the rear wall. Extend the horizontal line to the side wall allowing a 3° decline back (if required, see note below) towards the boiler, to enable condensate to drain back through the boiler. Mark the flue centre vertical line. (*figure 11*)

NOTE : Some flues may have the 3° built in and as such these flues may be installed in a horizontal position.

Figure 9

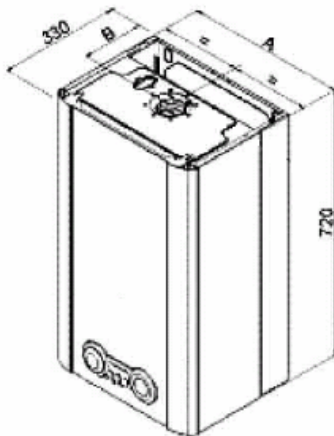
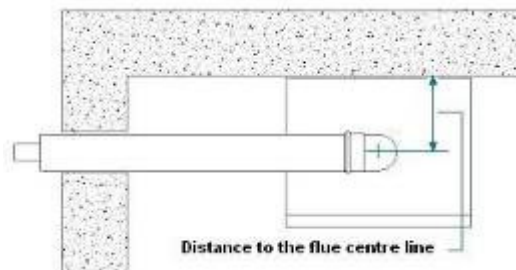

A: 430 mm
B: 166 mm

Figure 10

Figure 11

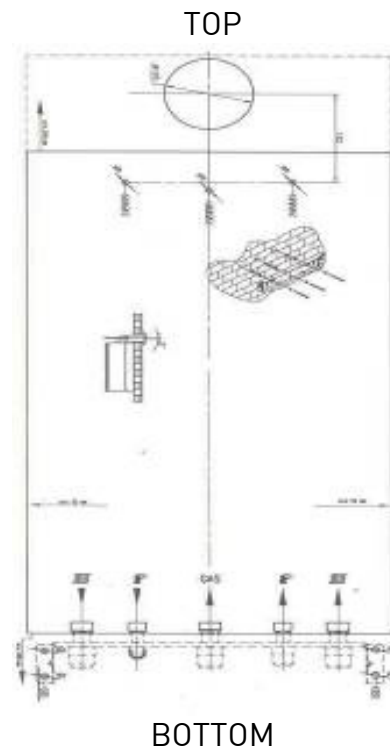

BOTTOM

10.4 When cutting the flue hole it is recommended that a 105mm diameter core drill is used where both internal and external access for the flue installation is available. Where only internal access is available a 125mm diameter core drill should be used. (Note: Please take adequate precautions to prevent debris entering the boiler via the flue outlet).

10.5 Using a 8.5mm drill bit, drill the holes for fixing jig (optional) and hanging bracket. Locate and secure the supplied wall mounting bracket and fixing jig in position (*figure 12*).

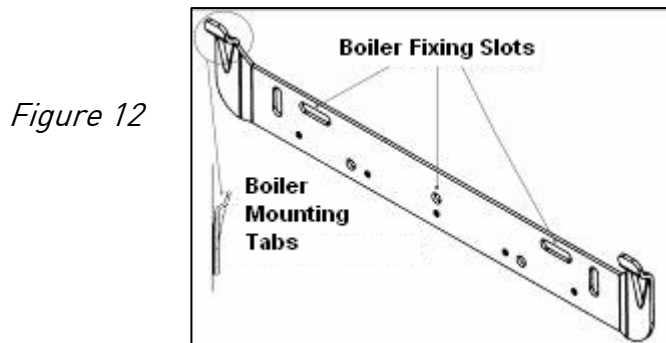

10.6 Mount the boiler onto the fixing bracket via the boiler mounting slots, (*figure 12*).

10.7 Connect isolation valves to the boiler ensuring the washers are fitted correctly.

NOTE: Refer to Figure 1 which shows the correct location of each valve.

10.8 Condensing type boilers must be connected to an appropriate drainage system either:

- a. A corrosion resistant or plastic drain must be fitted to allow discharge of condensate to a drain, see figure 16a.
- b. Discharged into the internal household draining system. If this is not practical, discharge can be made externally into the household drainage system or a purpose designed soak away.

10.9 Using 50cc of water prime the condensate by either removing the bottom of the trap using an appropriate allen key or via the inner flue duct at the top of the boiler.

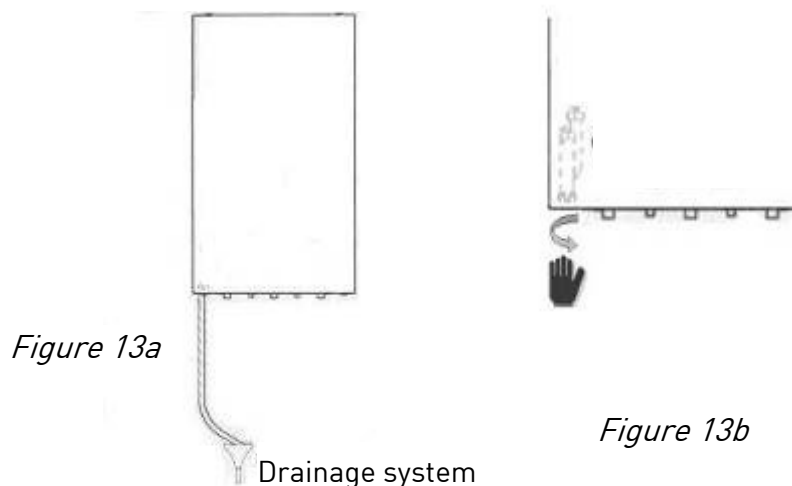

10.10 On installing the horizontal flue, determine the required length of the **outer air duct** by measuring the distance 'L' (*figure 14*) from the face of the external wall to the bottom of the larger socket of the boiler's elbow connecting collar.

NOTE: The measurement for the inner flue duct will be 'L' + 10mm and the maximum length of horizontal flue is 9.0m excluding the elbow connected to the boiler.

10.11 When fitting the terminal measuring from the back of the terminal connection, mark the distance 'L' onto the outer air duct. (*figure 14*)

10.12 Cut the **outer air duct only** to the required length ensuring that the cut is square and free from burrs.

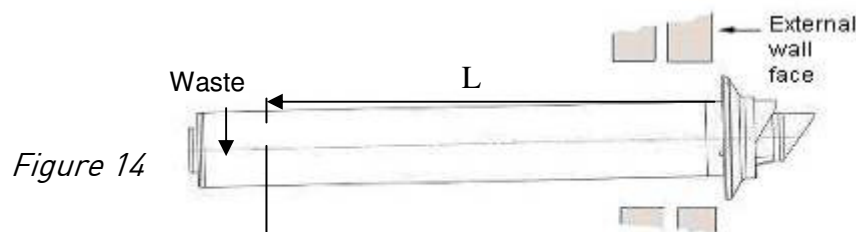

10.13 Measuring from the back of the terminal connection, mark distance 'L' + 10mm (*figure 15*) onto the inner flue duct and cut the duct to size, ensuring that the cut is square and free from burrs.

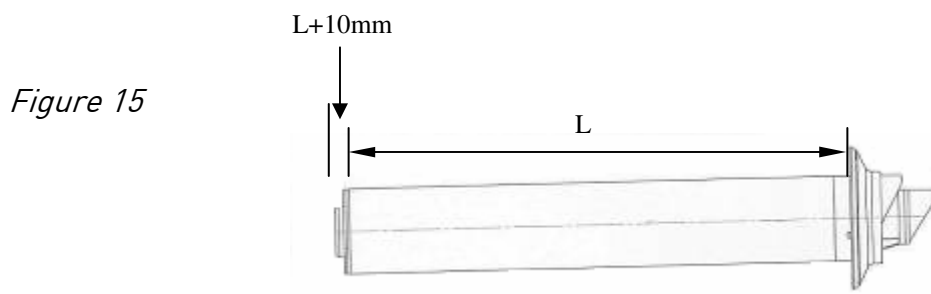

10.14 Pass the flue assembly through the wall and connect the assembly to the boiler, ensuring that both the air and flue duct joints are fully pushed home into the connecting elbow's collar.

10.15 With the flue and joints secured fit the flue trim to the external wall surface using a suitable mastic.

NOTE : Where there is no external access to the flue terminal the flue trim must be attached to the flue assembly prior to passing the assembly through the wall.

10.16 The vertical system diagram is shown in *figure 16*.

Note: Maximum vertical flue length is 9.0m.

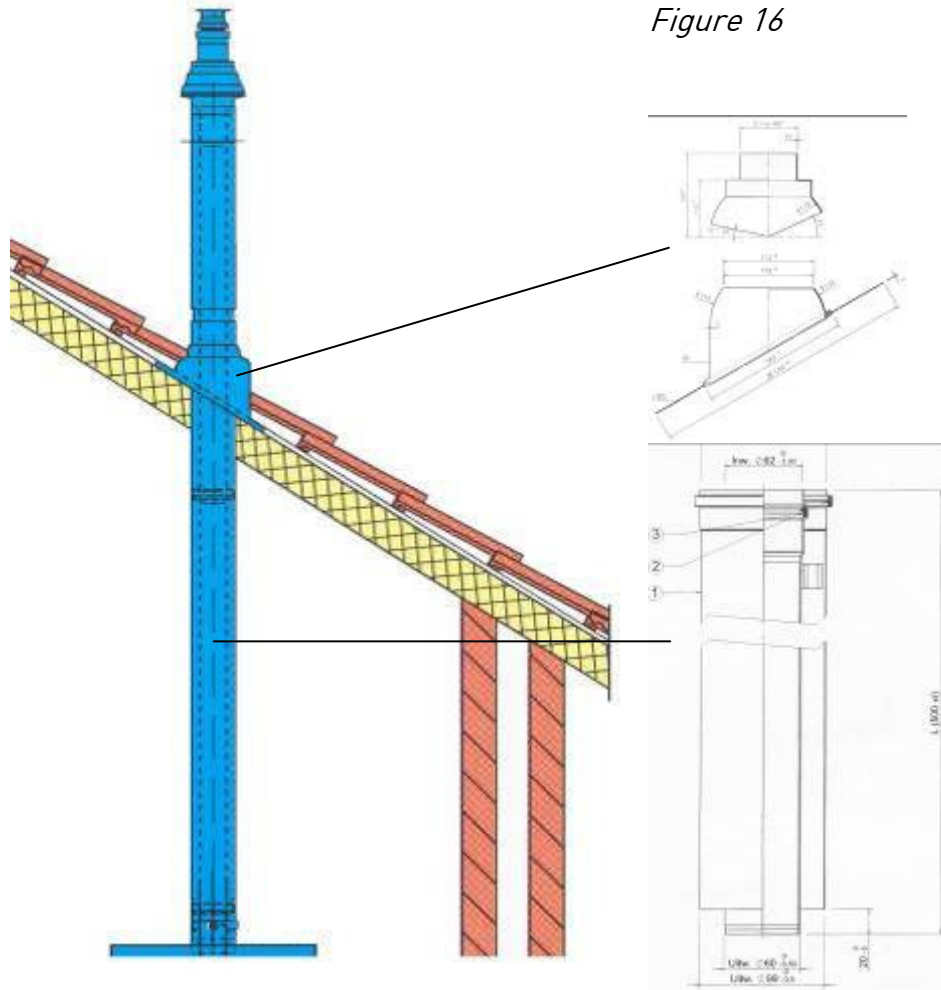

10.17 Provisions to fill the boiler and system must be made by the Installer, using an approved filling loop. The filling loop used must be approved to current water byelaws and fitted as close to the boiler as practicable. If it is not practicable to install the filling loop in an obvious position please add a label on the boiler to state where the filling loop can be found for future reference.

NOTE: Please instruct the user how to top up the pressure if required.

10.18 Connect the domestic hot water, cold water inlet, heating system flow & return and pressure relief valve pipework to the supplied boiler fittings, ensuring that the pipework has been correctly flushed before final connection.

10.19 The electrical connections to the boiler must be in accordance with Section 9 of these instructions.

10.20 The boiler should be filled using a filling loop with a double check valve, which should be disconnected when central heating system is pressurised at 1.5bar.

12.7 When the system is bled of any air it must be filled until the pressure gauge indicates a system pressure of 1.5bar.

12.8 If the pressure exceeds 1.5bar discharge the excess pressure from the system via a radiator valve or pipe connection. Do not use the safety discharge valve as the valve seat may become contaminated with debris and fail to re-seal.

Important Note.

In order to maintain the appliance's warranty; after initial filling the heating system must be thoroughly flushed using a propriety cleanser to remove foreign material and contaminants. Ensure the boiler is isolated before flushing the system.

13. Control Panel Functions

13.1 Central Heating and D.H.W. Temperature Controls: The boiler's integral control unit monitors and adjusts both the boiler's hydraulic circuit and D.H.W. water outlet temperatures by means of sensors located on the C/heating and D.H.W. flow outlets. The sensors convert the water temperature into an electrical resistance that is relayed back to the control potentiometers (2 & 3 figure 18) located on the control panel. The respective potentiometer control dial allows manual setting of the maximum required temperature (reference value) between 30° and 85°C for C/heating and 35° and 60°C for D.H.W. When the boiler functions in heating or D.H.W. mode, the resistance measured is compared to the manually set reference value. The differential determines the modulation of the gas valve adjusting the useful heat output generated and stabilising the temperature to within 1°C.

13.2 Re-set Function: Should the boiler lock out at any time, please check the water pressure, which should be between 0.8 and 2.0bar, the gas supply and ionisation probe position, the boiler may be re-started by switching to standby "0" position (Switch 4 figure 18) waiting 30 seconds and switching back to its previous position once the fault has been eliminated. If the problem re-occurs please seek advice.

13.3 Function Switch: The three position switch allows the boilers operation to be set to Stand-by (centre position -0) 'C.Heating + D.H.W.' (counterclockwise) or 'D.H.W. only' (clockwise), (Switch 4 figure 18).

12.7 When the system is bled of any air it must be filled until the pressure gauge indicates a system pressure of 1.5bar.

12.8 If the pressure exceeds 1.5bar discharge the excess pressure from the system via a radiator valve or pipe connection. Do not use the safety discharge valve as the valve seat may become contaminated with debris and fail to re-seal.

Important Note.

In order to maintain the appliance's warranty; after initial filling the heating system must be thoroughly flushed using a propriety cleanser to remove foreign material and contaminants. Ensure the boiler is isolated before flushing the system.

13. Control Panel Functions

13.1 Central Heating and D.H.W. Temperature Controls: The boiler's integral control unit monitors and adjusts both the boiler's hydraulic circuit and D.H.W. water outlet temperatures by means of sensors located on the C/heating and D.H.W. flow outlets. The sensors convert the water temperature into an electrical resistance that is relayed back to the control potentiometers (2 & 3 figure 18) located on the control panel. The respective potentiometer control dial allows manual setting of the maximum required temperature (reference value) between 30° and 85°C for C/heating and 35° and 60°C for D.H.W. When the boiler functions in heating or D.H.W. mode, the resistance measured is compared to the manually set reference value. The differential determines the modulation of the gas valve adjusting the useful heat output generated and stabilising the temperature to within 1°C.

13.2 Re-set Function: Should the boiler lock out at any time, please check the water pressure, which should be between 0.8 and 2.0bar, the gas supply and ionisation probe position, the boiler may be re-started by switching to standby "0" position (Switch 4 figure 18) waiting 30 seconds and switching back to its previous position once the fault has been eliminated. If the problem re-occurs please seek advice.

13.3 Function Switch: The three position switch allows the boilers operation to be set to Stand-by (centre position -0) 'C.Heating + D.H.W.' (counterclockwise) or 'D.H.W. only' (clockwise), (Switch 4 figure 18).

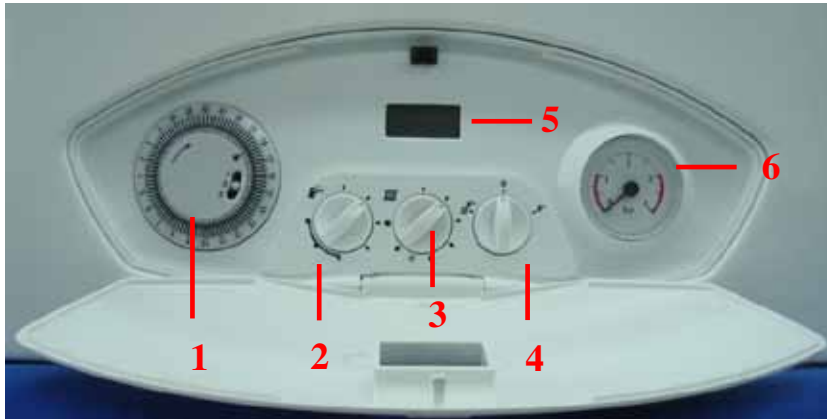

Figure 18

- | | |
|-------------------------------|------------------------|
| 1- Analogue Timer | 4- Function Switch |
| 2- D.H.W. Temperature Control | 5- LCD Display |
| 3- C.H. Temperature Control | 6- C.H. Pressure Gauge |

13.4 LCD Display: While giving the operational status of the boiler and water temperature, to aid in fault diagnostics the control unit has a built in facility that automatically indicates a fault status. If more than one fault simultaneously occurs, then only the highest priority fault is displayed. (Figure 19)

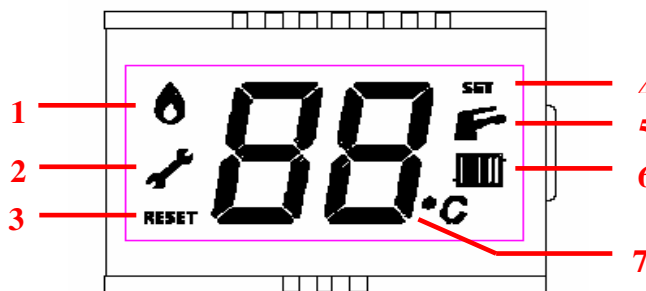

Figure 19

- | | |
|---------------------------|--------------------------------|
| 1- Flame Indicator | 5- D.H.W. Indicator |
| 2- Service Mode Indicator | 6- C.H. Indicator |
| 3- Reset Indicator | 7- Water Temperature Indicator |
| 4- Set Indicator | |

Failure Codes:

F0 - The Water Pressure is TOO LOW or TOO HIGH

F1 - Lockout due to overheating. This may be the overheat thermostat or thermal fuse.

NOTE: If the Thermal Fuse has blown the boiler will not re-set until the fuse has been replaced. See section 18.3

F2 - D.H.W. temperature probe damage

F3 - Primary temperature probe damage

F4 - Lockout due to ignition problem or Condensate Trap Blockage

F5 - Combustion product (flue) temperature probe damage

F6 - External temperature probe damage

F8 - Fan speed out of set range

F9 - Fan is moving when it should be stationary

OC - External sensor is connected and OTC enabled

CC - External sensor is disconnected and OTC disabled

13.5 Pressure Gauge The pointer on the gauge indicates the pressure within the boiler and central heating system and should, when the water is cold, read 1.5bar but may be between 1 and 2bar.

If the pressure gauge falls below 1bar the system and boiler must be re-pressurised. If there is a significant loss in pressure the boiler will lock out. The system may be re-charged by opening the filling loop to charge the system back up to 1.5bar (when cold) as indicated on the pressure gauge **DO NOT OVERCHARGE THE BOILER PRESSURE BEYOND 2BAR AS THE BOILER WILL NOT OPERATE.** The filling loop, a flexible hose with two valves, should be located below the boiler connecting the second pipe on the right to either one of the outer pipes, see *figure 2*. **DO NOT CLOSE ANY OF THE FOUR SERVICE VALVES CONNECTED DIRECTLY TO THE BOILER.** If the boiler frequently loses pressure then your installer should be consulted. Failure to have leakage repaired may cause corrosion within your heating system.

DIRECTLY CONNECTING TO THE BOILER. If the boiler frequently loses pressure then your installer should be consulted. Failure to have leakage repaired may cause corrosion within your heating system.

Figure 20



(9) A time clock allowing the automatic switching 'On' and 'Off' of the central heating is fitted as standard.

The operational time periods may be set as follows:

- ❑ Rotate the clock actuator mechanism clockwise, by hand, until the arrow indicates the current time, see figure 21. The example shows the current time is set at 21:05.
- ❑ The time is set in 24 hour format, e.g. the time for 1pm would be 13.
- ❑ Select the boiler "On" times by pushing the black tappets to the outside.
- ❑ Select the 'Off' times by pushing the black tappets towards the centre of the clock.

Figure 21

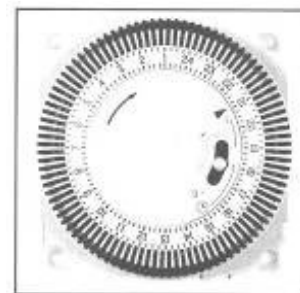

The clock operation can be set by the selection switch, which has three positions:

1. (Up) position: The boiler is controlled by the function switch (4, *Figure 18*) and operation is independent of the clock tappets.
2.  (Mid) position: The boiler is controlled by both function switch and clock tappets.
3. 0 (Down) position: The boiler is off independent of the function switch.

13.6 Service Mode Function: Turn the thermostat control knobs 2 & 3 *Figure 18* to minimum. Turn selector control knob (4 *figure 18*) from OFF to On (Heating Mode) three times each within a two second interval. A wrench symbol will be displayed in the LCD window and the boiler will ignite at minimum rate. The boiler is now in service mode and will stay there for 15mins, to obtain maximum rate simply turn the C/H control knob to max.

14. Commissioning

14.1 The boilers have been tested and pre-set at the factory and is dispatched with its on board controls set to provide maximum D.H.W output and a mid range heating output, see section 15.1 if adjustment is required. Consequently, once all the connections have been made and the boiler has been filled with water to the designed system operating pressure of 1.5bar, the boiler may be fired prior to adjustment of its pre-set parameters to match the heating system requirements.

14.2 Prior to firing, **the condensate trap must be filled with water and plastic discharge pipe connected to drain before operating the boiler, see section 10.9 for details**, check that the electrical supply to the boiler is 'On' (Indication is shown on the LCD display) and the gas service cock is in the open position.

- Set the boiler's central heating and domestic hot water temperature controls to maximum by turning them fully clockwise.
- Set the external room thermostat (if fitted) to maximum and set thermostatic radiator valves to maximum.

14.3 Switch the boilers function switch to the central heating and domestic hot water position. The boiler's control unit will now automatically carry out pre-ignition safety checks before igniting the burner.

14.4 On burner ignition check the integrity of the boiler's flue for tightness and correct operation.

14.5 Check the boiler for correct domestic hot water operation by opening and closing the household domestic hot water draw-off taps.

14.6 Restart the boiler and again allow the central heating system to reach maximum operating temperature. Check that all the water connections throughout the system are sound and bleed each of the heating systems radiators and purpose made air release points in turn.

14.7 Check the manual air vents, and bleed the heat exchanger by means of the screw on the manual air vent. Check the system pressure and top up if necessary.

14.8 Reset the central heating & domestic hot water temperature controls and room thermostat to the desired temperature settings.

14.9 IMPORTANT: Failure to thoroughly flush the heating system with proprietary cleanser (with the boiler disconnected), or to add an anti corrosion inhibitor to the system water may invalidate the boiler's warranty.

15. Onboard Adjustments

15.1 The boiler incorporates 4 potentiometers and a bank of 8 dip switches to allow adjustment to its pre-set parameters. These are situated on the rear of the control panel. (*figure 22*) and accessed by removal of the front panel and dropping the front of the control box, by releasing the two grey catches in the top corners. *Figure 23* shows default dipswitch settings.

Potentiometers on the back of the board:

No		Function	SARGON 24	SARGON 30	SARGON 35
			Factory Settings	Factory Settings	Factory Settings
1	R31	Maximum fan speed	2 o'clock	2 o'clock	2 o'clock
2	R29	Maximum CH power	6 o'clock	6 o'clock	6 o'clock
3	R30	Ignition power	6 o'clock	6 o'clock	6 o'clock
4	R28	Anti cycling time	9 o'clock	9 o'clock	9 o'clock

Dipswitches 1-8 on the back of the board:

No	Function	ON	OFF
S1	Gas Type S1	-	NG - LPG
S2	CH pump	45 sec post pump	OFF
S3	45 sec waiting time from DHW to CH	Yes	No (direct change over)
S4	DHW mode	Tank	Combi
S5	CAM timer	No	Yes
S6	CH 30°/85° - 30°/50°	30°/85°	30°/50°
S7*	Gas Type S7	No	Yes
S8*	Gas Type S8	Yes	No

NOTE*: Dip Switches S7 and S8 relate to the type of European gas used. These are factory set and must not be adjusted.

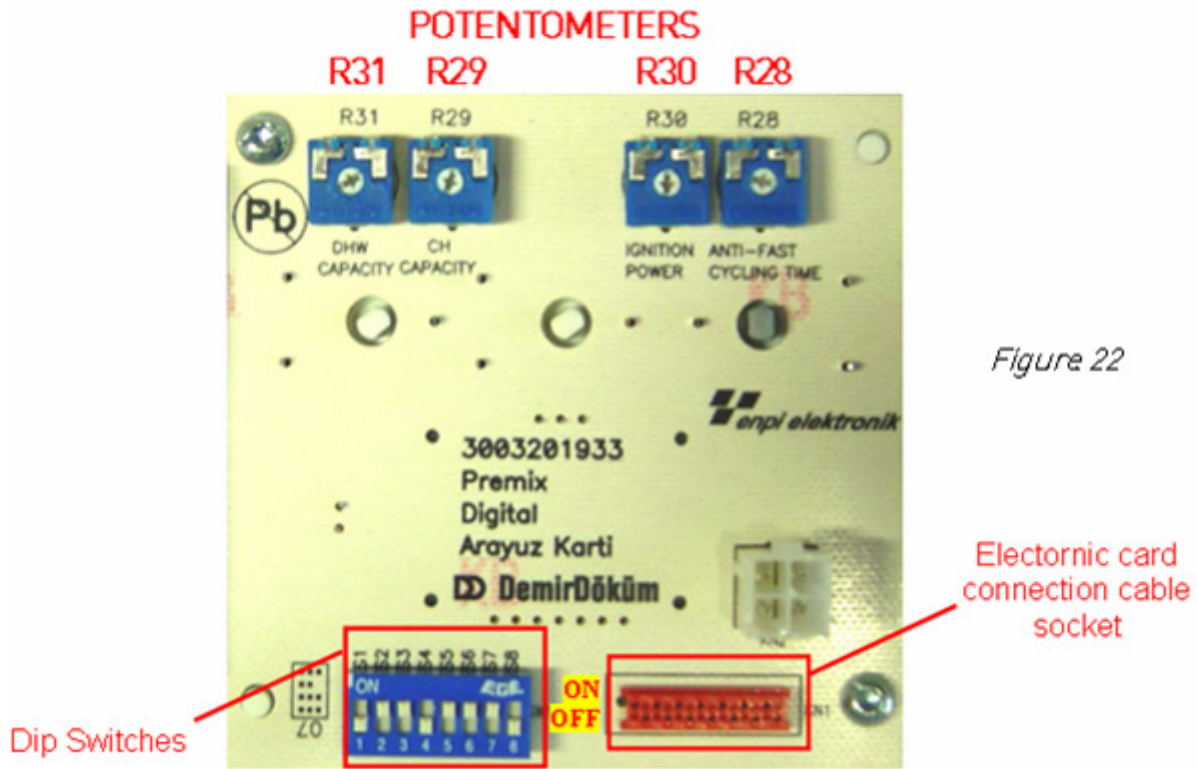

Figure 22

15.2 Setting the Maximum Central Heating Flow Temperature: The boiler is dispatched with the CH flow temperature set at 85°C. When a lower maximum temperature is required, such as in the case of under-floor heating, the factory setting can be adjusted to a maximum of 50°C giving a return temperature of 30°C, by setting dip switch 'S6' into ON position.

15.3 Setting the 45 second delay: The boiler is factory set to exclude the delay of 45 seconds before re-ignition after the closing of a hot water tap and CH start-up. This delay can be set to 45 seconds by setting dip switch 'S3' into the OFF position.

15.4 255 seconds delay setting: The boiler is capable of up to 255 seconds ignition delay (anti cycling time) before re-ignition following burner shut down on the primary hydraulic water reaching its set temperature. This delay can be increased up to a maximum of 255 seconds by turning potentiometer R28 (Figure 22) clockwise.

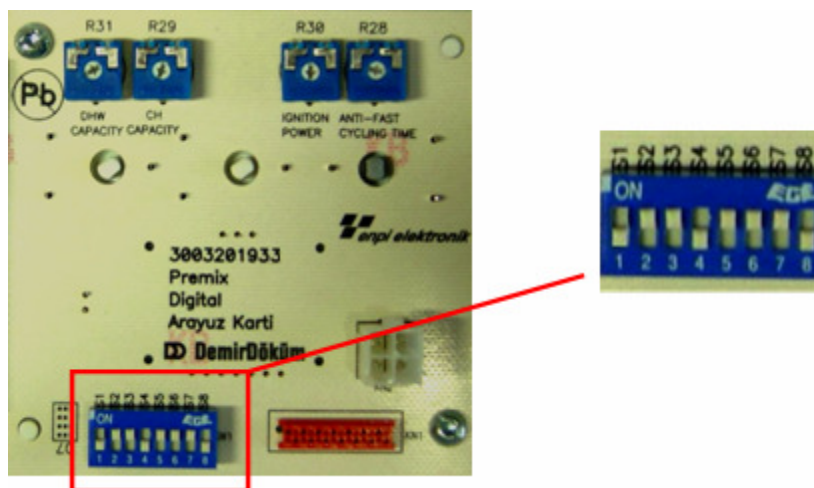

Figure 23

15.5 Pump working mode setting: The boiler has a factory set to operate the pump for pre-purge and post-purge times (45 sec.). This delay can be excluded by fitting dipswitch 'S2' (*figure 23*) into ON position. However, this may then cause the boiler over-heat thermostat to trip out.

15.6 The maximum and minimum heat output for heating and domestic hot water: Hot water output is dictated by demand whilst the heating is pre-set on potentiometer 29 at 4 o'clock (*figure 22*). The C/H may be adjusted to match your heating requirement if required.

15.7 Gas valve ignition capacity. The graduated opening of the gas valve for ignition rate is governed by the potentiometer R30 control, which is factory set at 6 o'clock.

15.8 The boiler's integral pump is factory set to its maximum speed setting to give a 1000 l/hr flow on a nominal 4m head. The pump may be adjusted to a lower speed to match the designed c/heating system requirements. (*See Figure 24 for flow rates*)

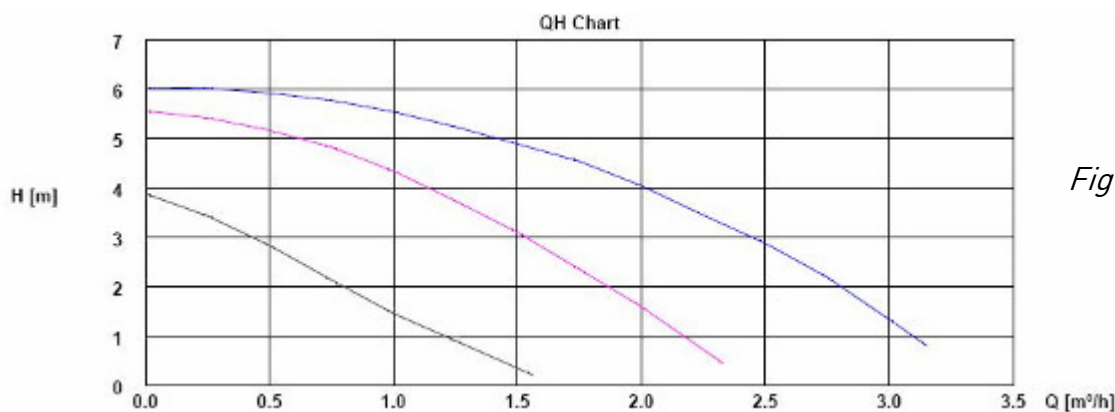

Figure 24

16. Safety Devices

16.1 An hydraulically operated primary pressure switch monitors water pressure or water shortage in the primary hydraulic circuit and will switch the boiler off if the pressure is below 0.8bar. The boiler will not operate until the circuit has been re-pressurised. The recommended pressure of the system is 1.5bar when cold.

16.2 The temperature of the water flowing from the primary heat exchanger is monitored by an overheat thermostat located on the outlet pipe. If the water temperature gets too hot the switch opens, cutting off the electrical supply to the gas valve and causing the boiler to 'Lock-out', fault code F1. Once activated the boiler has to be cooled and manually re-set by switching the control knob off for a minimum of 30sec and on again. If the boiler fails to re-set then the Thermal Fuse described in Section 18.3 must be checked and replaced if necessary.

16.3 The boiler's control unit has an in-built frost protection device that fires the boiler's burner when the temperature of the primary hydraulic water falls below 6°C. The device works irrespective of any room thermostat setting and will protect the boiler. Once the water temperature reaches 16°C the boiler reverts back to

normal operation. If there is a risk of pipes freezing in exposed places these should be well lagged and the system drained and power switched off if the property is left empty for long periods during cold weather.

16.4 If there is a fault on the DHW sensor, the boiler will continue to operate by using the CH temperature sensor to control the water temperature. Note that this will limit the domestic hot water temperature to 65°C. If such a failure occurs a fault code, F2, will be displayed on the LCD display, please contact your service agent if the boiler fails to re-set see section 13.2.

17. Routine Servicing

17.1 To ensure the continued efficient and safe operation of the boiler it is recommended that it is checked and serviced regularly. The servicing must be carried out by a competent person in accordance with the Gas (Safety and Use) Regulations. The frequency of servicing will depend upon the particular installation conditions and usage, but in all cases the boiler must be serviced at least once a year following the procedures set out below..

17.2 Prior to servicing a check of the flue operation and terminal guard (if fitted) along with a preliminary check of the boilers operation must be undertaken.

17.3 Ensure that both the electrical and gas supplies to the boiler are isolated before commencing any work on the boiler.

17.5 Remove the boiler casing as follows:

- Open the front panel by removing two screws at the bottom corners of the boiler. See (*figure 25*).



Figure 25

17.6 Remove the combustion chamber cover by removing two screws at the sides. See (*figure 26*)

Figure 26

- Release the side panels by removing the screws on the upper and lower sides (*figure 27*). Remove the panels by swinging them out and lifting them up.

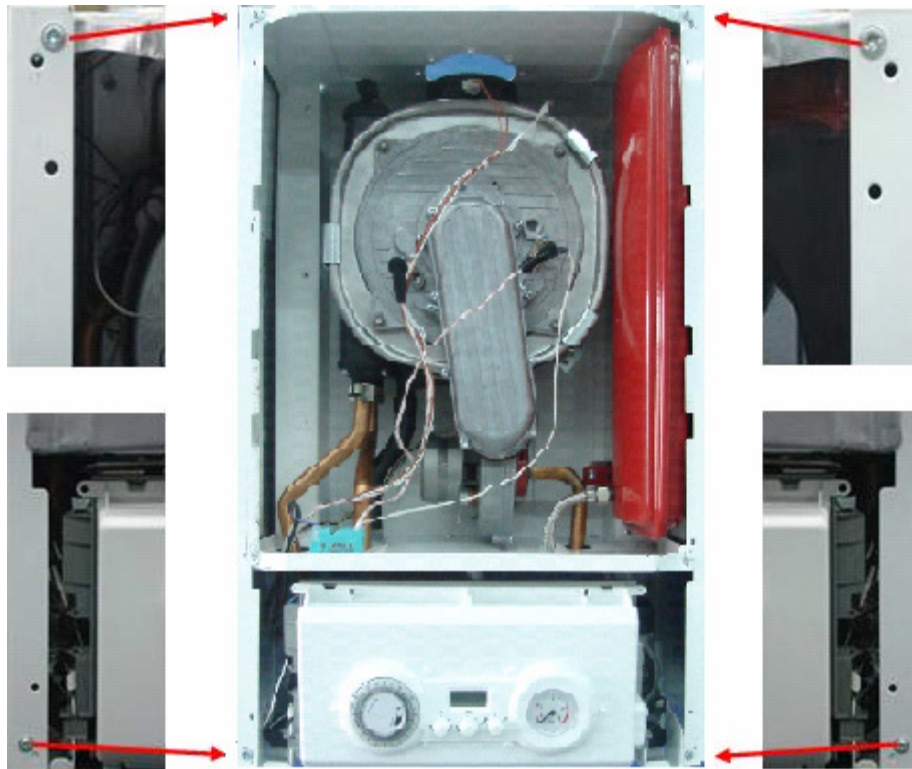

Figure 27

17.7 Swing the control panel down towards you exposing the gas valve and hydraulic circuits. Undo the nut on top of the gas valve, *figure 28*, and release the pipe from the fan assembly. (Be careful not to damage or dislodge the restrictor located in the gas valve outlet) Remove the nuts from around the heat exchanger and after disconnecting the electrodes, *figure 29*, pull the fan and burner assembly forward giving access to the fan connections. Release the electrical leads and remove the burner/fan assembly. (*Figure 30*)



Figure 28

Ionisation
electrodeIgnition
electrode

Figure 30

17.8 Visually check for debris/damage and clean or replace as necessary the following items as shown in the previous pictures:

- ⇒ Heat exchanger
- ⇒ Burner
- ⇒ Fan
- ⇒ Electrodes
- ⇒ Insulation/gaskets

IMPORTANT

- ❖ Clean the heat exchanger using a soft brush or vacuum cleaner. **Do not** use any tool likely to damage the surface of the heat exchanger.
- ❖ Clean the burner by washing in soapy water. Allow to dry thoroughly before re-fitting.
- ❖ **Do not** use wire or a sharp instrument to clean the burner ports.

17.9 The boiler is fitted with a domestic cold water inlet filter, which may become blocked during the use of the boiler causing the water flow rate to become reduced. To gain access to the filter:

- ❑ Close the isolating valve on boiler's cold water inlet by turning the valve head fully clockwise.
- ❑ Open one or more hot water taps to drain the hot water circuit.
- ❑ Disconnect the cold water inlet connection to the boiler.
- ❑ Remove the filter housing from below the boiler using a 14mm spanner. Clean and inspect the filter, replace if necessary as described in section 18.16.
- ❑ Re-fit the filter and reinstate the cold water inlet connection to the boiler.
- ❑ Fully open the isolating valve on the boiler's cold water inlet and check for leaks when the hot water taps are closed and the circuit is pressurised .

17.10 On completing the service reassemble the boiler components in reverse order. Take care not to damage or dislodge the gas restrictor and ensure that all component joints, gaskets are sound. Any damaged gaskets must be replaced.

17.11 Reinststate the boiler's electrical and gas supplies and check for gas tightness and correct boiler operation.

17.12 Due to the construction of the heat exchanger the condensate trap should not become contaminated. However, it may be flushed if required by pouring hot water through the heat exchanger discharge pipe, which can be seen in figure 31a. If this is not successful the bowl of the trap can be removed using a large allen key in the socket of the outlet tube of the bowl after the flexible pipe has been removed from underneath, see figure 31b.

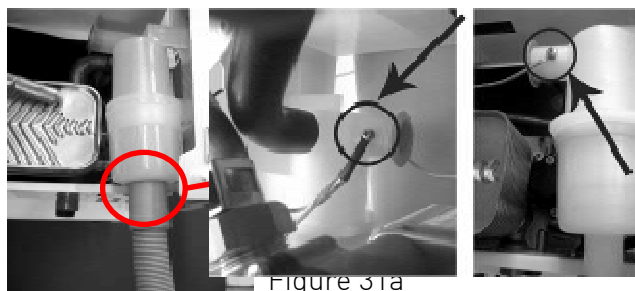

Figure 31a

Figure 31b

17.13 Following servicing of the boiler the

relevant sections of the 'Benchmark' Installation, Commissioning and Servicing Log Book, found at the back of these instructions, must be completed and the combustion ratio checked via the access port on the flue elbow. For natural Gas the CO₂ should be 8.5% at Min and 9.1% at Max, for LPG 10.6% at Min and 10.7%.at Max. The CO/CO₂ ratios should be less than 0.004.

18. Component Replacement

CAUTION!

While there are no substances harmful to health contained within this appliance, some component parts of the boiler (insulation pads, gaskets and rope seals) are manufactured from man made fibres. When damaged or broken these fibres may cause a temporary irritation. High dust levels may irritate eyes and upper respiratory system. It is important therefore, that sensible precautions are applied when exchanging components.

NOTE:

1. Ensure that both the electrical and gas supplies to the boiler are isolated before replacing any component part.
2. To prevent the need to drain the entire heating system when replacing the boiler's integral pump, expansion vessel, safety relief valve and pressure sensor, the boiler's hydraulic circuit may be isolated from the central heating circuit by closing the boilers isolation valves below the boiler. Opening the plastic drain cock, which is located below the boiler and behind the pump, will then drain the boiler's hydraulic circuit. If the water does not drain freely open the manual vent on top of the boiler.
3. For replacement of the following components it will be necessary to remove the boiler casing panels as described in Section 17.

18.1 Domestic Hot Water Sensor

- ❑ Read the notes at the head of this section before commencing any work on the appliance.
- ❑ The domestic hot water temperature sensor (Immersion type) is located on the right hand side of the hydraulic block as shown in *figure 32*.
- ❑ Carefully disconnect the leads from the sensor.
- ❑ Remove the sensor using a 13mm spanner.
- ❑ Fit the replacement sensor ensuring the washer is correctly fitted.
- ❑ Re-fit the leads to the replacement sensor

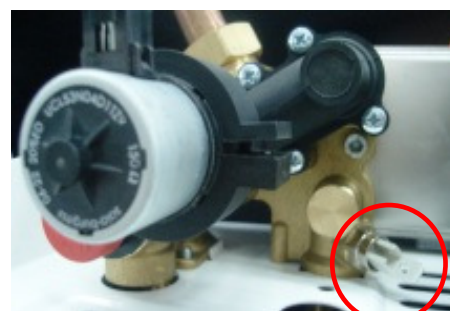

Figure 32

Flue Sensor



Figure 33

18.2 Central Heating and Flue Sensor

- ❑ Read the notes at the head of this section before commencing any work on the appliance.
- ❑ The Flue sensor is located on the plastic flue socket. (*Figure 33*)
- ❑ The Central heating ntc sensor is located on the pipe. (*Figure 34*)
- ❑ Disconnect the leads from the sensors.
- ❑ Remove the sensors from the pipe/plastic flue.
- ❑ Fit replacement sensors.
- ❑ Fit the leads to replacement sensors.



Figure 34

18.3 Thermal Fuse

- ❑ Read the notes at the head of this section before commencing any work on the appliance.
- ❑ The thermal fuse is located at the top right of the heat exchanger.
- ❑ Squeeze the plug to disconnect catch and pull off the electrical connector. Then using a spanner remove the thermal fuse. Note this is a dry pocket and does not require the boiler to be drained.
- ❑ Read the notes at the head of this section before commencing any work on the appliance.

18.4 Fan

- ❑ Read the notes at the head of this section before commencing any work on the appliance.
- ❑ Swing the control panel down towards you exposing the gas valve and hydraulic circuits. Undo the nut on top of the gas valve, figure 28, and release the pipe from the fan assembly. (Be careful not to damage or dislodge the restrictor located in the gas valve outlet)
- ❑ Remove the nuts securing the fan assembly to the front of the heat exchanger and , pull the fan assembly forward giving access to the fan connections.
- ❑ Release the electrical leads and remove the burner/fan assembly
- ❑ Fit the replacement fan unit in reverse order and reconnect all electrical leads.

18.5 Spark Generator

- ❑ Read the notes at the head of this section before commencing any work on the appliance.
- ❑ **NOTE** the orientation of the spark generator and locations, 1-4, of the cables attached before removing them. *See Figure 35.*

Terminal 1	Live
Terminal 2	Neutral
Terminal 3	Rectification
Terminal 4	Spark Ignition



Figure 35

- ❑ Remove the two screws securing the generator.
- ❑ Fit the new generator in the same orientation and reattach the leads to terminals 1-4 as removed. *See Figure 35.*

18.6 Printed Circuit Board (PCB)

- ❑ Read the notes at the head of this section before commencing any work on the appliance.
- ❑ Remove interface cover by lifting the two latches. *(figure 36)*
- ❑ Access the main PCB by opening the PCB cover.
- ❑ **NOTE the location** of each plug before removing the electrical connections from the PCB by releasing the clips and carefully pulling off the connectors.

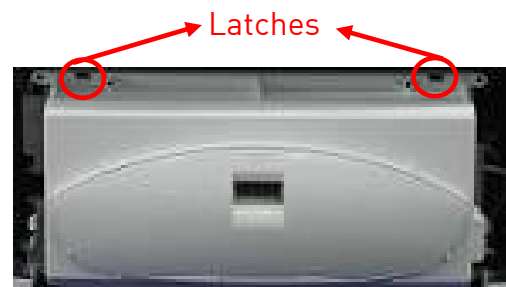

Figure 36

- ❑ Release the 4 screws securing the PCB to the control panel and lift out the PCB
- ❑ Fit the replacement PCB in reverse order of removal, ensuring that the PCB electrical connections are correctly located and fully pushed home.

18.7 Pump

- ❑ Read the notes at the head of this section before commencing any work on the appliance.
- ❑ The order of removal is dependant on whether it is the motor or body that has failed.

In case of motor failure:

- ❑ Disconnect the screws connecting the pump head to the body, *figure 37*.
- ❑ Pull off the pump head and disconnect the electrical connection from the cable connection box of the pump, *figure 38*.



Figure 37



Figure 38

- ❑ Fit the replacement motor in reverse order ensuring the correct polarity of the electrical connections
- ❑ Open the isolating valves on the flow and return connections, refill, vent and re-pressurise the water system **to 1.5bar** ensuring the pump union joints are sound.

In case of pump body damage:

- ❑ Remove the motor as described above.
- ❑ Remove the plate heat exchanger as detailed in (18.7).
- ❑ Remove the expansion vessel pipe connection by releasing the clip on the pump body.
- ❑ Remove the pressure switch connection as detailed in (18.13).
- ❑ Disconnect the pumps outlet fitting. (*figure 39*)
- ❑ Remove the fixing screws on the pump and hydraulic block, located at the bottom right of the boiler. (*figure 40*)
- ❑ Remove the pump body assembly.
- ❑ Detach the pump body from the hydraulic block by removing the clip.



Figure 39



Figure 40

- ❑ Fit the replacement body in reverse order ensuring that the pump washers are fitted and the correct polarity of the electrical connections is maintained.
- ❑ Open the isolating valves on the flow and return connections, refill, vent and re-pressurise the system ensuring the pump union joints are sound.

18.8 Plate Heat Exchanger

- ❑ Read the notes at the head of this section before commencing any work on the appliance.
- ❑ Remove the two screws, which connect the heat exchanger to the hydraulic block. *(figures 41)*

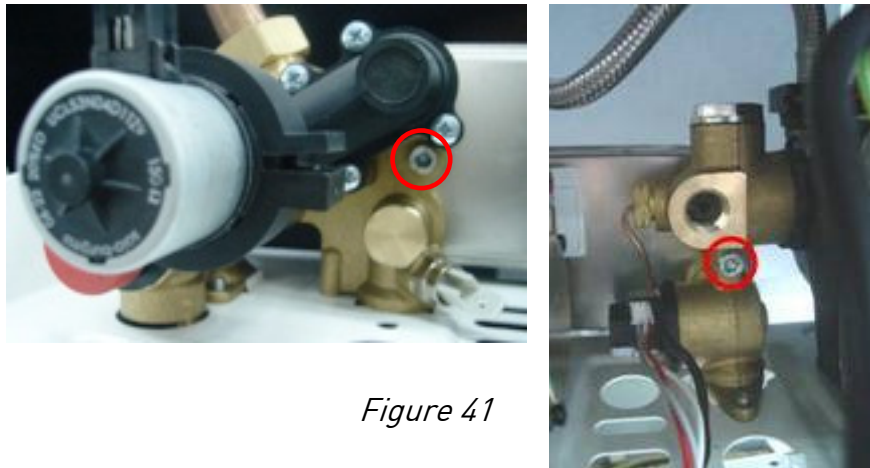

Figure 41

- ❑ Remove the heat-exchanger via the gap at the left hand side.
- ❑ Fit the new heat exchanger and reassemble the boiler in reverse order ensuring all washers are fitted correctly. (Replace and damaged washers as required)
- ❑ Open the isolating valves on the flow and return connections, refill, vent and re-pressurise the system to 1.5bar ensuring all joints are sound.

18.9 Primary Heat Exchanger and Burner

- ❑ Read the notes at the head of this section before commencing any work on the appliance.
- ❑ Disconnect the pipes from the heat exchanger.
- ❑ Release the union connections on the pump and hydraulic block, retaining the washers for re-assembly.
- ❑ Remove the pump, heat-exchanger and heat-exchanger three-way valve connecting pipes.
- ❑ Remove the burner as detailed in **(17.8)**
- ❑ Remove the screws from the brackets retaining the exchanger.

- ❑ Remove the heat exchanger by pulling forward.
- ❑ Fit the new heat exchanger and reassemble the boiler in reverse order ensuring all the washers and seals are fitted correctly. (Replace any damaged washers or seals)
- ❑ Open the isolating valves on the flow and return connections, refill, vent and re-pressurise the system ensuring that all joints are sound.
- ❑ Check the manual air-vent, and vent the air from the heat exchanger by means of the screw cap on top of the manual air-vent.

18.10 Gas Valve

- ❑ Read the notes at the head of this section before commencing any work on the appliance.
- ❑ Disconnect the silicone tube and electrical connections from the gas valve.
- ❑ Undo the nut on top of the gas valve, *figure 42*, and release the pipe from the fan assembly. (Be careful not to damage or dislodge the restrictor located in the gas valve outlet)



Figure 42

- ❑ Release the main gas connection below the gas valve.
- ❑ Remove the gas valve's two securing screws and washers from the bottom side of boiler. (*Figure 43*)
- ❑ Rotate the gas pipe and withdraw gas valve assembly.



Figure 43

- ❑ Carefully remove the restrictor from the top of the gas valve and insert it into the top of the new valve.
- ❑ Refit in reverse order to removal replacing any seals and gaskets as required.
- ❑ Check for gas tightness and correct boiler operation.

- Where necessary the gas valve settings may be re-calibrated by the following method in 18.10.

18.11 Gas Conversion Setting

- Read the notes at the head of this section before commencing any work on the appliance.
- Insert a combustion analyser into the socket on the flue adapter.
- Check the Potentiometer setting R31.

R 31 potentiometer adjustment (clockwise)	
G20	
SARGON 24 / 30	SARGON 35
2 o'clock	10 o'clock

- In order to set the appliance in service Mode turn the two control knobs 2 & 3 *Figure 18* to minimum and switch the control knob 4 from OFF to On (Heating Mode) three times each within a two second interval. A wrench symbol will be displayed in the LCD window and the boiler will ignite at minimum rate.
- In this mode of operation the gas rate will be controlled by the CH control for 15min, after which time normal operation will take over and the wrench symbol will disappear.
- With the CH control knob at minimum gas rate using a 6mm allen key **adjust the gas valve to give a CO₂ of 8.5% (Natural Gas) or 10.6% for LPG, adjusting clockwise: to increase the CO₂ setting or anticlockwise: to decrease the CO₂.**
- With the CH control knob at maximum gas rate, check that the CO₂ is 8.5 % (Natural Gas) or 10.7% (LPG).
- NOTE ALL GAS RATIOS MUST BE LESS THAN 0.004.



Figure 44

18.12 Expansion Vessel

- ❑ Read the notes at the head of this section before commencing any work on the appliance.
- ❑ Disconnect the pipe coupling on the expansion vessel (*figure 45*).
- ❑ Lift the pressure vessel out of boiler from the gap over the chassis and fit the replacement vessel to the boiler in reverse order of removal ensuring the sealing washer is fitted to the pipe connection before tightening. (Replace the washer if required)



Figure 45



Figure 46

- ❑ Using a pressure sensor, check that the expansion vessel charge pressure is 0.5bar (7.5psi)
- ❑ Open the isolating valves on the flow and return connections, refill, vent and pressurise the boiler ensuring all joints are sound.

18.13 Overheat Safety Thermostat

- ❑ Read the notes at the head of this section before commencing any work on the appliance.
- ❑ Locate the overheat safety thermostat upstream of the three way valve (*figure 47*).

Over heat thermostat



Figure 47

- ❑ Disconnect the electrical connections from the thermostat.
- ❑ Remove the thermostat from the pipe being careful not to damage the retaining clip.
- ❑ Fit the replacement thermostat in reverse order to removal.

18.14 Pressure Sensor

- ❑ Read the notes at the head of this section before commencing any work on the appliance.
- ❑ Disconnect and remove the sensor cable and sensor from the hydroblock. *(figure 48)*
- ❑ Fit the replacement pressure sensor in reverse order ensuring the gasket is correctly fitted. (Replace the gasket if damaged)



Figure 48

18.15 Hydroblock

- ❑ Read the notes at the head of this section before commencing any work on the appliance.
- ❑ Remove the secondary heat exchanger as detailed in **18.7**.
- ❑ Remove the pump with the hydroblock section as detailed in **18.6**.
- ❑ Remove the section of the hydroblock from the pump by releasing the clip.
- ❑ Release the heat-exchanger outlet pipe nut and rotate the pipe for ease of removal from the remaining section of the hydroblock as described in **18.2**.
- ❑ Disconnect the three way valve stepper motor electrical connection and remove the stepper motor by releasing the clip as described in **18.17**
- ❑ Release the nut connecting the CH outlet connection to the hydroblock *(figure 49)*.
- ❑ Disconnect the DHW sensor as described in **18.1**.
- ❑ Remove the screw securing the remaining section of the hydroblock to the combination boiler *(figure 50)*.
- ❑ Fit the replacement hydroblock sections (figure 51) in reverse order of removal ensuring all components are assembled correctly. Replace any seals or gaskets as required



Figure 49



Figure 50

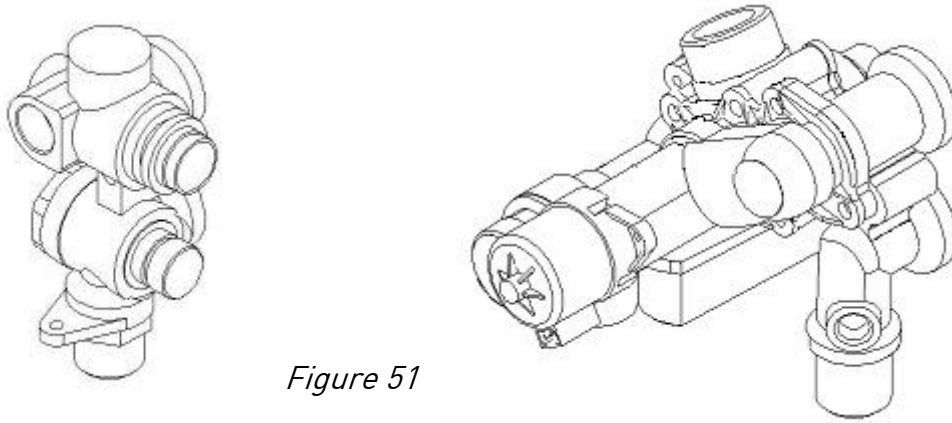

Figure 51

- ❑ Open the isolating valves on the flow and return connections, refill, vent and pressurise boiler ensuring all joints are sound.

18.16 DHW Filter.

- ❑ Close the Domestic Hot Water inlet valve to the boiler.
- ❑ Drain the domestic hot water circuit by opening the hot taps.
- ❑ Disconnect the cold water feed to the boiler.
- ❑ Remove the filter from underneath the inlet of the hydroblock using a 14mm spanner.
- ❑ Clean or fit replacement filter.
- ❑ Assemble components in reverse order of removal ensuring all the components are assembled correctly.
- ❑ Open the isolating valves on the flow and return connections, refill, vent and pressurise the boiler ensuring all joints are sound.

18.17 Flow Switch

- ❑ Remove the flow switch by using a pair of snipe nose pliers (*figure 48*).
- ❑ Remove the cable attachment.
- ❑ Fit the replacement sensor in reverse order of removal.



Figure 52

18.18 Stepper Motor

- ❑ Read the notes at the head of this section before commencing any work on the appliance.
- ❑ Disconnect the electrical connections from the stepper motor by depressing the clip at the front and lifting the connector out of its socket.
- ❑ Squeeze the retaining clip, on the ring securing the motor, to release the retaining ring. After removing the retaining ring pull out the Motor from its socket.

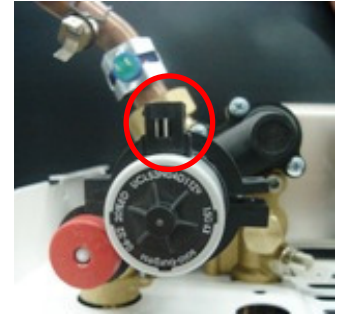

Figure 53

18.19 Pressure relief valve.

- ❑ Read the notes at the head of this section before commencing any work on the appliance.
- ❑ Disconnect the discharge pipe on the outlet of the safety valve.
- ❑ Disconnect the safety valve from the diverter valve.
(Figure 54)
- ❑ Fit the replacement safety valve in reverse order from removal and refill, vent and pressurise the boiler ensuring all joints are sound and service valves open.



Figure 54

19. Gas Conversion

Warning

Gas conversion must be carried out by a competent person as defined in the Gas Safety (Installation and Use) Regulations.

19.1. If gas conversion is required (from NG to LPG etc.), follow the instructions below using only approved components from your agent:

- ❑ A flue gas analyser must be used when making any adjustments that can affect the combustion characteristics of the boiler. (this includes converting to a different gas type)
- ❑ Change the diaphragm, which is located in the outlet of the gas valve. (NG - 7 mm , LPG - 5.0 mm)
- ❑ Once re-assembled check for gas tightness.
- ❑ Set the CO₂ as described in section **18.11 Gas Conversion Setting** noting the correct CO₂ value for the type of gas that will be used.
- ❑ Check for correct boiler operation.

Important.

Gas type conversion must be completed by attaching the labels included in the gas conversion kit to the boiler.

- Type of gas label – in a visible position inside the boiler.
- Grey label – to cover the existing gas type on the data plate.
- Instruction label – Inside drop down cover on the front of the boiler.

NOTE:

When installing, commissioning or servicing a gas appliance that incorporates a pre-mix burner and zero-set governor, because it is not possible to measure an operating pressure the engineer should first check that the gas supply is metered and ascertain whether it is possible to measure the gas rate. If the gas input rate can be measured then the requirements of GSIUR 26(9) can be met, including any specific requirements in manufacturers' instructions. If gas input rate cannot be measured then, to satisfy the intent of GSIUR 26(9), the engineer shall measure the combustion quality of the appliance in accordance with BS 7967 or the technical data of this manual.

If the engineer does not have the required equipment and no alternative test is specified by the manufacturer then the appliance shall be turned off and disconnected as an un-commissioned appliance until such time that equipment is available to undertake such tests.

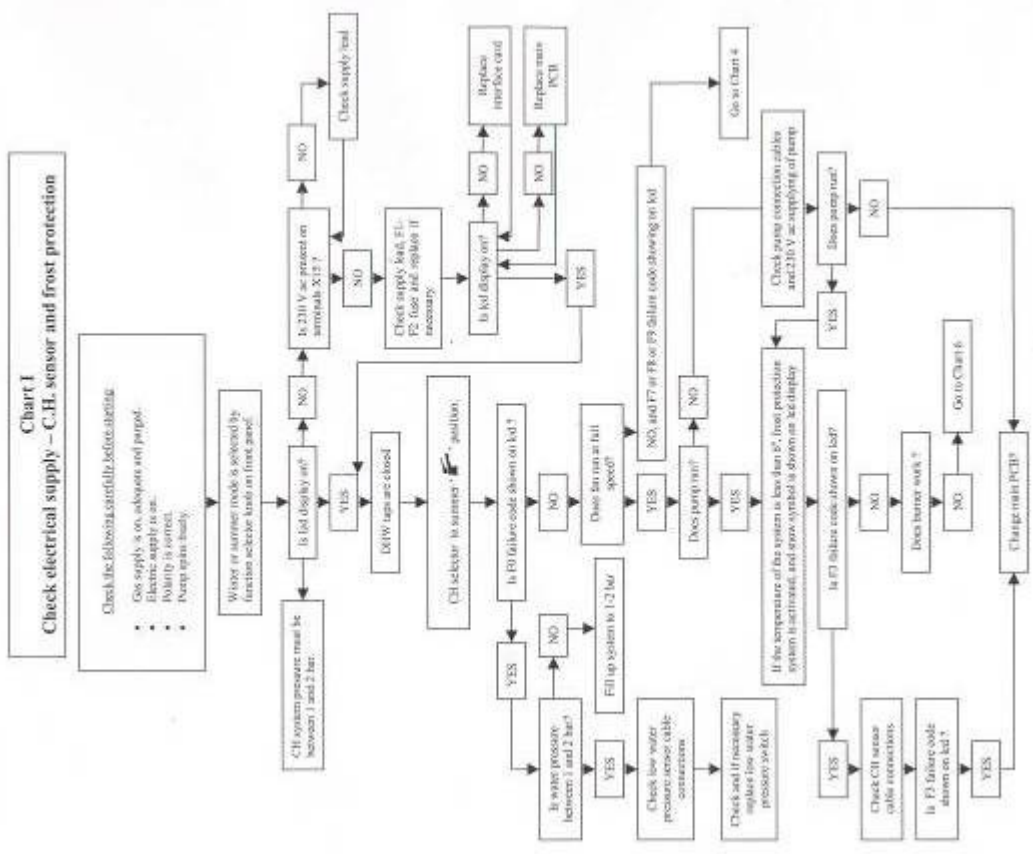
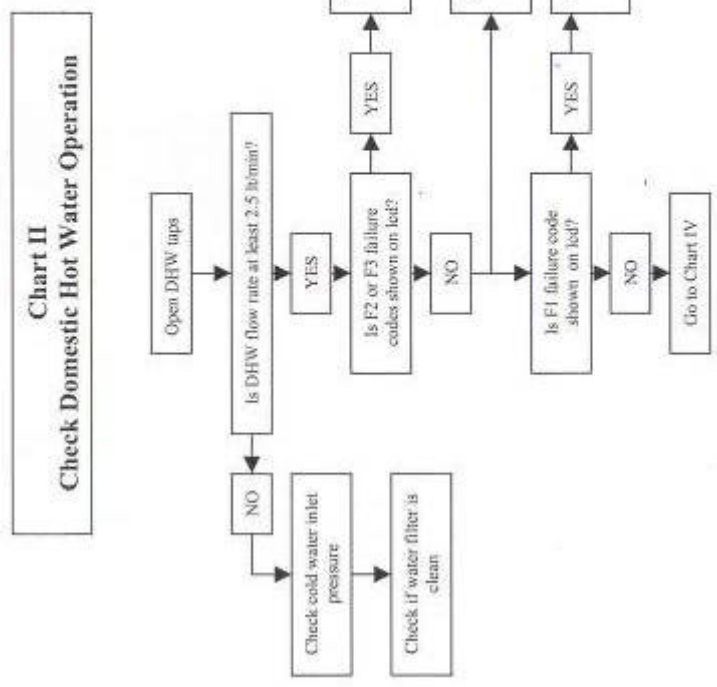

Chart III Check Central Heating Operation

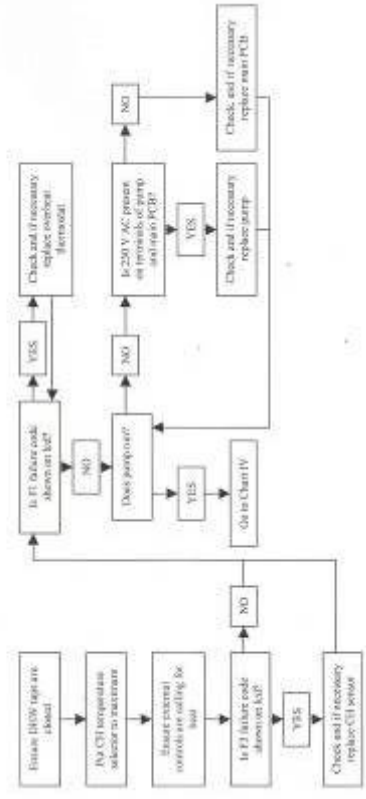

Chart IV Fan Operation

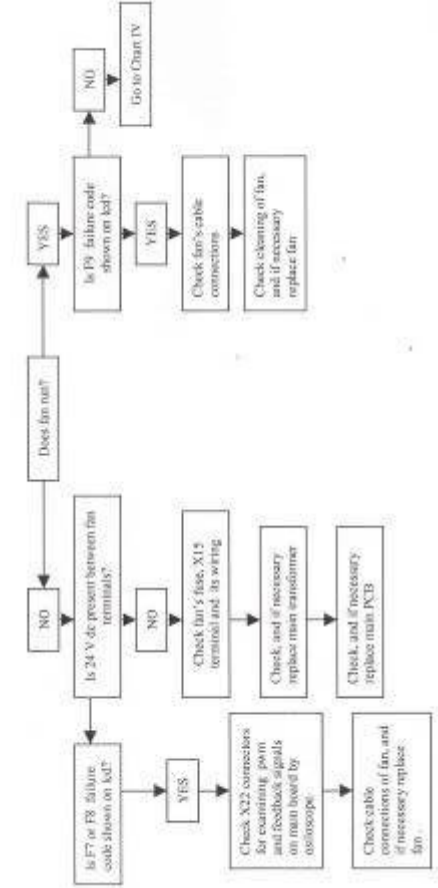

Chart VI
Check Ignition System

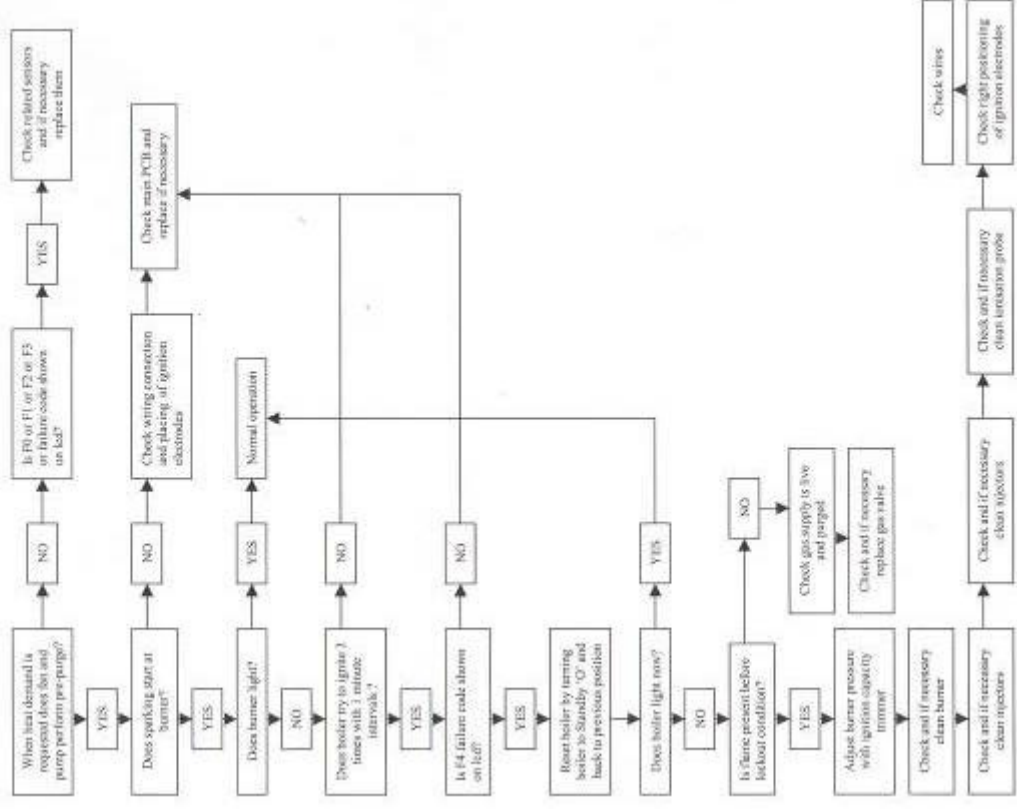
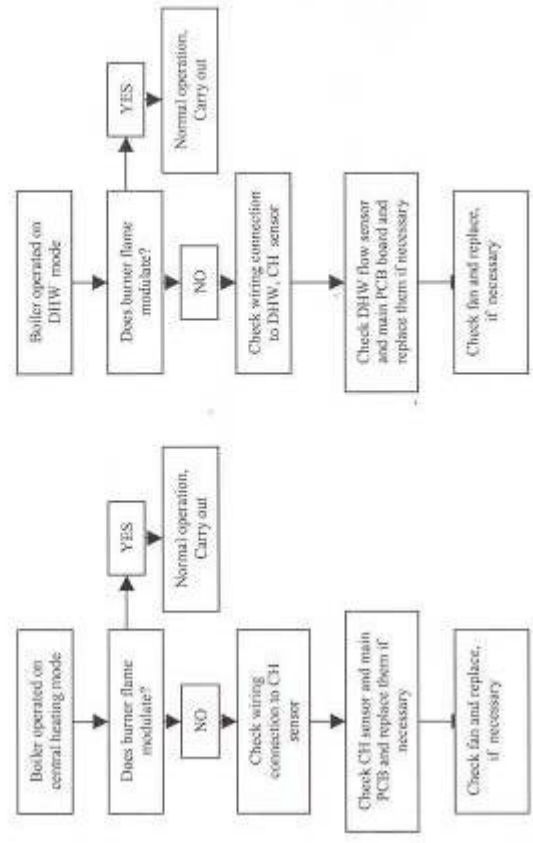

Chart V
Check DHW and CH modulation



APPENDICES

Appendix 1 Spare Parts

PART No.	DESCRIPTION	ORDER CODE
1	PRESSURE RELIEF VALVE	3003200038
2	PUMP	3003201336
3	EXPANSION VESSEL	3003201948
4	GAS VALVE	3003201365
5	AIR/GAS MIXER	3003201366
6	AIR/GAS MIXER RING (RED)	3003200659
7	CONTROL PANEL	3003201247
8	PCB COVER	3003200084
9	CIRCUIT BOARD	3003201368
10	INTERFACE BOARD	3003201932
11	WIRING HARNESS WITH TIMER	3003201954
12	SECONDARY HEAT EXCHANGER (24 kW)	3003200896
13	IGNITION ELECTRODE CABLE	3003201985
14	IONASITON ELECTRODE CABLE	3003201986
15	FLUE SENSOR	3003201949
16	CH SENSOR (NTC)	3003200152
17	FAN	3003201367
18	LIMIT THERMOSTAT	3003200397
19	FRONT PANEL	3003201988
20	SPARK GENERATOR	3003201369
21	DIVERTER VALVE MOTOR (ONLY)	3003200039
22	RETURN GROUP	3003200018
23	DIVERTER VALVE	3003200017
24	CONDENSATE TRAP	3003201775
25	RETURN HYDROBLOCK	3003201509
26	THERMAL FUSE	3003201961



**SARGON 24 / 30 / 35
PRE-MIX
CONDENSING
COMBINATION BOILER**

User Instructions



Natural Gas

Heat Line™ Sargon Pre-mix Condensing Combination Boiler

British Gas Service Listing:

SARGON 24	G.C.No. 47-157-15
SARGON 30	G.C.No. 47-157-16
SARGON 35	G.C.No. 47-157-17

Notified Body

IMQ 51BP2750	Directive 90/396/EEC
51BP2751DR	Directive 92/42/EEC



The Heat Line™ range of central heating boilers are manufactured from high quality materials and designed for reliability and optimum performance.

Heat Line™ are committed to the continual development of their appliances and reserve the right to make changes without notification to ensure their customers benefit from the latest advances in combustion technology and energy conservation.

'Benchmark' Log Book

As part of the industry-wide initiative the boiler comes complete with an Installation, Commissioning and Service Record Log Book. Please read the Log book carefully, pages 57&58, and complete all sections, as required by law, relevant to the appliance and installation. The details within the Log Book will be required in the event of any warranty work.

On completion the Log Book must be left with the end user and the relevant sections completed on each subsequent Service visit.

NOTE: The installation of this boiler must be registered with C.O.R.G.I. Should you wish to check the SEDBUK website for the rating of this boiler search under DD HEATING or the boiler name and designation, e.g. SARGON 24.

The manufacturer, in the drive for continuous improvement of his products, reserves the right to modify the data expressed in the present documentation at any time and without prior notice.

The present documentation is an informative support and it cannot be considered as a contract towards third parties.

IMPORTANT INFORMATION

The Heat Line™ boiler is a high efficiency gas fired boiler and represents the highest level of technology found in today's gas boiler market.

In order to maintain peak efficiency along with optimum performance and reliability it is essential that the boiler be serviced at least once per year by a competent person such as a CORGI Registered Engineer.

All C.O.R.G.I. Registered Installers carry a C.O.R.G.I. ID card and have a registration number, which should be recorded and entered on your benchmark log book. You can check your Installer registration by contacting C.O.R.G.I. on 01256 372300

The boiler's '**Log Book**', which is found at the back of these instructions must be completed at each Service visit.

GAS SAFETY (INSTALLATION AND USE) REGULATIONS

It is a legal requirement that all gas appliances must be installed and serviced by a competent or C.O.R.G.I. registered person in accordance with the above regulations. Failure to install or service gas appliances correctly may invalidate your guarantee and could lead to a dangerous situation. It is in your interest and that of safety to ensure compliance with the law.

For electrical safety the boiler must be earthed and protected by a **3 -amp fuse**.

Note. In the event of a fault the appliance should not be used until a competent person has corrected the fault.

VENTILATION

For maintenance and safety purposes, the boiler has been installed with a minimum space of 200mm above, 300mm below, 600mm to the front and 50mm to either side of the boiler case. (*figure 1*) It is essential that this space is not restricted by the addition of shelves etc. fitted above or below the boiler, or to the boiler sides. See section 6 for detail

GENERAL DESCRIPTION OF THE BOILER

The boiler is a combined domestic hot water and central heating appliance. Its internal control unit electronically provides direct burner ignition and combustion supervision along with continuous modulation of the burner's gas supply. By means of a manual switch the boiler



Figure 1

can be set to operate in one of two operating modes, domestic hot water only or domestic hot water and central heating.

DOMESTIC HOT WATER MODE:

When hot water demand is requested the boiler will fire automatically. An integral pump is then energised and hot water from the boiler's primary circuit is circulated through the secondary heat exchanger, allowing the instantaneous transferral of heat to the incoming cold water. The secondary heat exchanger is protected against an internal build up of lime scale by limiting the hot water temperature at the tap to a maximum of 60°C. Hot water will continue to flow through the tap until no longer required. When the demand for hot water ceases the integral pump may continue to run for a short while to dissipate any excess heat within the boiler.

DOMESTIC HOT WATER AND CENTRAL HEATING MODE:

When heating demand is requested by the time clock (and thermostat) the boiler will fire automatically. An integral pump is then energised and hot water from the boiler's primary circuit is circulated around the heating system's pipe-work and radiators. The heat output from the boiler is automatically adjusted by the boiler's internal control unit to match the heating demand. As the water temperature of the heating system increases the gas input to the burner decreases, conserving energy and increasing efficiency. When the demand for heating no longer exists, either the room thermostat is satisfied or the heating period has ended, the burner will shut down and the boiler will revert to stand-by, waiting to respond to the next heating demand. The integral pump may continue to run after shut down for a short while to dissipate any excess heat within the boiler.

Please Note. When domestic hot water is called for during the heating mode, the boiler will automatically revert to domestic hot water mode until the demand for hot water ceases.

NOTE: Depending on the boiler set up there may be a delay of 45secs before the boiler re-fires.

ACCESS TO THE BOILER CONTROLS.

The boiler controls are sited at the bottom of the boiler's front case. *(See figure 2)*



Figure 2

BOILER CONTROLS

The function and operation of the main controls located on the control panel fascia (figure 3) is as follows:

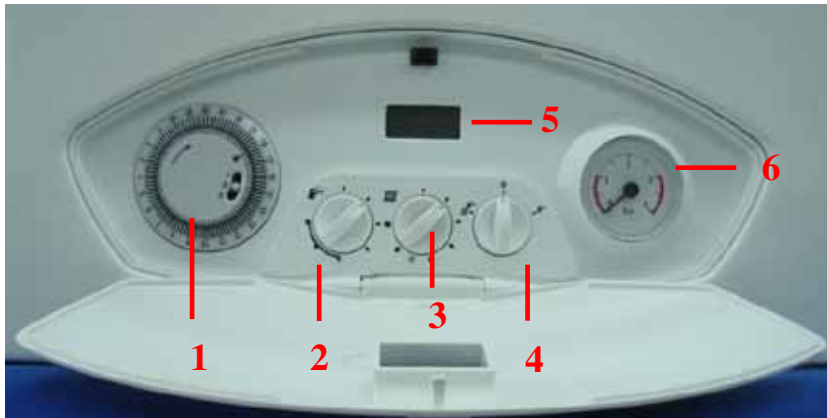







Figure 3

- | | |
|-------------------------------|------------------------|
| 1- Analogue Timer | 4- Function Switch |
| 2- D.H.W. Temperature Control | 5- LCD Display |
| 3- C.H. Temperature Control | 6- C.H. Pressure Gauge |

- 1. Pressure Gauge :** Shows water pressure in the system. Scale from 0 - 4bar. Recommended water pressure in system 1.5bar.
- 2. Domestic Hot Water Temperature Control :** The position of this control dial will determine the temperature of the domestic hot water delivered to the taps or shower unit. The water temperature can be set from a minimum of 35°C (anticlockwise stop position) to a maximum of 60°C (clockwise stop position.)
- 3. Central Heating Temperature Control :** The position of this control dial will determine the temperature of the water delivered to the radiators. The water temperature can be set from a minimum of 30°C (anticlockwise stop position) to a maximum of 85°C (clockwise stop position), unless the boiler is adjusted for under floor heating operation when the maximum setting is 60°C.
- 4. Function Switch :** This is the boilers main operating switch. In the  position the boiler is in stand-by mode and power supply is ON. For the boiler to operate the switch must be in the  or  position. When switched to the  position the boiler will operate only to supply domestic hot water. (Summer use) For the boiler to operate to give both central heating and domestic hot water the switch must be in the  position.(Winter use)

5. **LCD Display Screen:** While giving the operational status of the boiler and water temperature, to aid in fault diagnostics the control unit has a built in facility that automatically indicates a fault status. If more than one fault simultaneously occurs, then only the highest priority fault is displayed.

(Figure 4)

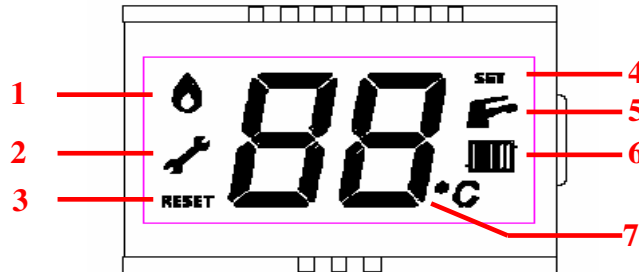



Figure 4

5.1. Flame indication: When ignition occurs, flame symbol (1) is shown.

5.2. Re-set symbol : When reset symbol (3) is showed with fault code, the boiler will need to be re-set. To re-set the boiler, the function switch must be switched to  position and after 30seconds turn back to its previous (summer or winter) position. If the fault continues to occur seek advice as to curing the problem.

5.3. Domestic Hot Water Mode : When opening tap, system works at DHW mode and shows tap symbol.

5.4. Central Heating Mode : When selecting winter mode and working at CH mode, system shows radiator symbol.

5.5. Digits : Digits shows CH,DHW temperature, fault codes etc.

6. Timer : The operational time periods may be set as follows:

- ❑ Rotate the clock actuator mechanism clockwise, by hand, until the arrow indicates the current time, see figure 5. The example shows the current time is set at 21:05.
- ❑ The time is set in 24 hour format, e.g. the time for 1pm would be 13.
- ❑ Select the boiler "On" times by pushing the black tappets to the outside.
- ❑ Select the 'Off' times by pushing the black tappets towards the centre of the clock.

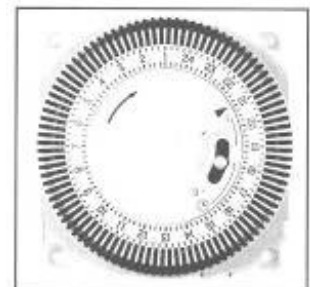



Figure 5

The clock operation can be set by the selection switch, which has three positions:

4. I (Up) position: The boiler is controlled by the function switch (4, *Figure 18*) and operation is independent of the clock tappets.
5.  (Mid) position: The boiler is controlled by both function switch and clock tappets.
6. 0 (Down) position: The boiler is off independent of the function switch.

FROST PROTECTION

The boiler has a built in frost protection device that protects the boiler from freezing. If the boiler is to be left and there is a risk of frost, ensure that the gas and electrical supplies are left connected. The frost protection device will light the boiler when the temperature of the boiler water falls below 6°C. When the temperature reaches 15°C, the boiler will shut down.

Note: This device works irrespective of any room thermostat setting and will protect the boiler, but not necessarily the full system. Ensure that vulnerable sections of the circuit are adequately lagged.

SYSTEM PRESSURE

On installation your installer will have filled the boiler and system to its effective working pressure. The boiler's pressure gauge should be regularly checked to ensure that this pressure is maintained between 1 and 2 bar. If there is a significant loss in pressure the boiler will lock out. The system may be re-charged by opening the filling loop to charge the system back up to 1.5bar as indicated on the LCD panel. **DO NOT OVERCHARGE THE BOILER PRESSURE BEYOND 2BAR AS THE BOILER WILL NOT OPERATE.** The filling loop, a flexible hose with two valves, should be located below the boiler connecting the second pipe on the right to either one of the outer pipes, see *figure 11 on page 15*. **DO NOT CLOSE ANY OF THE FOUR SERVICE VALVES.**

DIRECTLY CONNECTING TO THE BOILER. If the boiler frequently loses pressure then your installer should be consulted. Failure to have leakage repaired may cause corrosion within your heating system.

OPERATING THE BOILER

Prior to operating the boiler, check that the pressure reading, on the LCD panel, lies between 1 and 2bar.

Set the boiler's 'Central Heating' and 'Domestic Hot Water' temperature controls to maximum by turning fully clockwise and set the external 'Room Thermostat' (if fitted) to maximum. (To set the room thermostat refer to its manufacturer's instructions.)

Switch the boiler's functional switch to the  position. The boiler's integral control unit will now automatically carry out pre-ignition safety checks before finally igniting the burner.

The 'Central Heating' and 'Domestic Hot Water' temperature controls and 'Room Thermostat' can now be set to the desired temperature settings.

When a demand for heat no longer exists, the burner will automatically shut down but the green 'Boiler Stand by' indicator will remain alight. The boiler will be ready for the next heating demand.

CLEANING

The boiler casing may be cleaned with a damp cloth followed by a dry cloth to polish. **Do not** use abrasive or solvent cleaners.

FURTHER ADVICE

For further advice or information contact Heat Line TM Service Enquiries by telephone

Service: 0870 777 8341

Spares: 0870 777 8402

Technical Help Line: 0870 777 8318

E-mail via our web site: www.heatline.co.uk



The code of practice for the installation, commissioning & servicing of gas central heating

Installation, Commissioning and Service Record Log Book

NAME

ADDRESS

TEL No.

1. Please keep the Log Book in a safe place future reference.
2. This Log Book is to be completed in full by the competent person(s) who commissioned the boiler and associated equipment and then handed to the customer. When this is done, the Log Book is a commissioning certificate that can be accepted as evidence of compliance with the appropriate Building Regulations.
3. Failure to install and commission this appliance to the manufacturer's instructions may invalidate the warranty.

The above does not affect your statutory rights.

The content of this Log Book has been produced in consultation with  Benchmark is supported by 

© CENTRAL HEATING INFORMATION COUNCIL

INSTALLER & COMMISSIONING ENGINEER DETAILS

COMPANY NAME _____ INSTALLATION DATE _____
 ADDRESS _____
 INSTALLER'S NAME _____ TEL No. _____
 CORGI REGISTRATION DETAILS _____
 REG No. _____ CORGI ID SERIAL No. _____

NAME _____ COMMISSIONING DATE _____
 ADDRESS _____
 TEL No. _____
 CORGI REGISTRATION DETAILS _____
 REG No. _____ CORGI ID SERIAL No. _____

APPLIANCE & CONTROL DETAILS

BOILER
 MAKE AND MODEL _____ SEDBUK No. _____
 APPLIANCE SERIAL No. _____
 LOCATION _____
 NEW SYSTEM or REPLACEMENT BOILER

CONTROLS

To comply with the Building Regulations, each section must have a tick in one or other of the boxes.

REQUIREMENT	MEASURES PROVIDED	
1. TIME AND TEMPERATURE CONTROL TO HEATING	ROOM STAT & PROGRAMMER/TIMER <input type="checkbox"/>	PROGRAMMABLE ROOMSTAT <input type="checkbox"/>
2. TIME AND TEMPERATURE CONTROL TO HOT WATER	CYLINDER STAT & PROGRAMMER/TIMER <input type="checkbox"/>	COMBI BOILER <input type="checkbox"/>
3. HEATING ZONE VALVES	FITTED <input type="checkbox"/>	NOT REQUIRED <input type="checkbox"/>
4. THERMOSTATIC RADIATOR VALVES	FITTED <input type="checkbox"/>	NOT REQUIRED <input type="checkbox"/>
5. AUTOMATIC BYPASS TO SYSTEM	FITTED <input type="checkbox"/>	NOT REQUIRED <input type="checkbox"/>
6. BOILER INTERLOCK	PROVIDED <input type="checkbox"/>	NOT REQUIRED <input type="checkbox"/>

PLEASE FOLLOW THE INSTALLATION AND COMMISSIONING INSTRUCTIONS IN THE INSTALLATION MANUAL SUPPLIED WITH THE EQUIPMENT

COMMISSIONING PROCEDURE INFORMATION

FOR ALL BOILERS

HAS THE SYSTEM BEEN FLUSHED IN ACCORDANCE WITH THE BOILER MANUFACTURER'S INSTRUCTIONS? YES NO
 WHAT WAS THE CLEANER USED? _____ YES NO
 HAS AN INHIBITOR BEEN USED? _____
 WHICH INHIBITOR WAS USED? _____

FOR THE CENTRAL HEATING MODE, MEASURE AND RECORD

HEAT INPUT _____ kW
 BURNER OPERATING PRESSURE _____ mbar
 CENTRAL HEATING FLOW TEMPERATURE _____ °C
 CENTRAL HEATING RETURN TEMPERATURE _____ °C

FOR COMBINATION BOILERS ONLY

HAS A WATER SCALE REDUCER BEEN FITTED? YES NO
 WHAT TYPE OF SCALE REDUCER HAS BEEN FITTED? _____

FOR THE DOMESTIC HOT WATER MODE, MEASURE AND RECORD

MAXIMUM OPERATING WATER PRESSURE _____ bar
 COLD WATER INLET TEMPERATURE _____ °C
 HOT WATER OUTLET TEMPERATURE _____ °C
 WATER FLOW RATE AT MAXIMUM SETTING _____ l/min

FOR CONDENSING BOILERS ONLY

HAS THE CONDENSATE DRAIN HAD BEEN INSTALLED IN ACCORDANCE WITH THE MANUFACTURER'S INSTRUCTIONS? YES NO

FOR ALL INSTALLATIONS

DOES THE HEATING AND HOT WATER SYSTEM COMPLY WITH THE APPROPRIATE BUILDING REGULATIONS? YES
 HAS APPLIANCE AND ASSOCIATED EQUIPMENT BEEN INSTALLED AND COMMISSIONED IN ACCORDANCE WITH THE MANUFACTURER'S INSTRUCTIONS? YES
 HAVE YOU DEMONSTRATED THE OPERATION OF THE APPLIANCE AND SYSTEM CONTROLS TO THE CUSTOMER? YES
 HAVE YOU LEFT ALL THE MANUFACTURER'S LITERATURE WITH THE CUSTOMER? YES
 COMPETENT PERSON'S SIGNATURE _____ CUSTOMER'S SIGNATURE _____

(To confirm demonstrations of equipment and receipt of appliance instructions)

SERVICE INTERVAL RECORD

It is recommended that your heating system is serviced regularly and that your service engineer completes the appropriate Service Interval Record below.

SERVICE PROVIDER

Before completing the appropriate Service Interval Record below, please ensure you have carried out the service as described in the boiler manufacturer's instructions and in compliance with The Gas Safety Regulations. Always use the appropriate manufacturer's specified spare part when replacing gas controls.

SERVICE 1 DATE _____

ENGINEER NAME _____
 COMPANY NAME _____
 TEL. No. _____
 CORGI ID SERIAL No. _____
 COMMENTS _____
 SIGNATURE _____

SERVICE 3 DATE _____

ENGINEER NAME _____
 COMPANY NAME _____
 TEL. No. _____
 CORGI ID SERIAL No. _____
 COMMENTS _____
 SIGNATURE _____

SERVICE 5 DATE _____

ENGINEER NAME _____
 COMPANY NAME _____
 TEL. No. _____
 CORGI ID SERIAL No. _____
 COMMENTS _____
 SIGNATURE _____

SERVICE 7 DATE _____

ENGINEER NAME _____
 COMPANY NAME _____
 TEL. No. _____
 CORGI ID SERIAL No. _____
 COMMENTS _____
 SIGNATURE _____

SERVICE 9 DATE _____

ENGINEER NAME _____
 COMPANY NAME _____
 TEL. No. _____
 CORGI ID SERIAL No. _____
 COMMENTS _____
 SIGNATURE _____

SERVICE 2 DATE _____

ENGINEER NAME _____
 COMPANY NAME _____
 TEL. No. _____
 CORGI ID SERIAL No. _____
 COMMENTS _____
 SIGNATURE _____

SERVICE 4 DATE _____

ENGINEER NAME _____
 COMPANY NAME _____
 TEL. No. _____
 CORGI ID SERIAL No. _____
 COMMENTS _____
 SIGNATURE _____

SERVICE 6 DATE _____

ENGINEER NAME _____
 COMPANY NAME _____
 TEL. No. _____
 CORGI ID SERIAL No. _____
 COMMENTS _____
 SIGNATURE _____

SERVICE 8 DATE _____

ENGINEER NAME _____
 COMPANY NAME _____
 TEL. No. _____
 CORGI ID SERIAL No. _____
 COMMENTS _____
 SIGNATURE _____

SERVICE 10 DATE _____

ENGINEER NAME _____
 COMPANY NAME _____
 TEL. No. _____
 CORGI ID SERIAL No. _____
 COMMENTS _____
 SIGNATURE _____

When all of the above services have been completed, please contact your Service Engineer for an additional service interval record sheet.

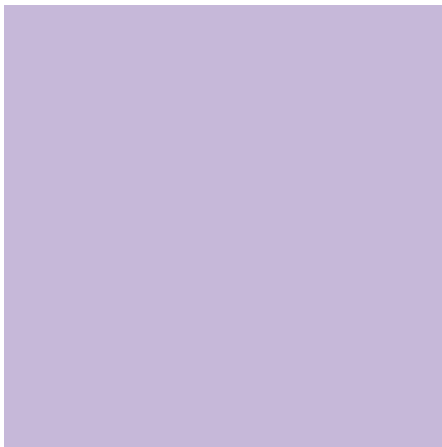

Heatline
Nottingham Road,
Belper,
Derbyshire,
DE56 1JT

Tel: 01773 596 099
Fax: 01773 828 123
Email: sales@heatline.co.uk