



# Rocco

Model No. FCFL\*\*RN3

## LOG EFFECT CONVENTIONAL FLUE ROOM HEATER

### User Instructions

**These instructions should be read by the user before operating the appliance and retained for future reference**

**Model No. FCFL\*\*RN3 is for use on Natural Gas (G20) at a supply pressure of 20 mbar in G.B. / I.E.**

**\*\* Denotes trim & colour variant**

## **INSTALLATION INFORMATION**

### **CONDITIONS OF INSTALLATION**

It is the law that all gas appliances are installed only by a competent (e.g. GAS SAFE Registered) Installer, in accordance with the installation instructions and the Gas Safety (Installation and Use) Regulations 1998 as amended. Failure to install appliances correctly could lead to prosecution. It is in your own interest and that of safety to comply with the law.

The fire may be fitted below a combustible shelf provided that the shelf is at least 300mm above the top of the appliance and the depth of the shelf does not exceed 150mm.

The fire may be installed below combustible shelves, which exceed 150mm deep providing that the clearance above the fire is increased by 15mm for each 25mm of additional overhang in excess of 150mm.

If this appliance is fitted directly on to a wall without the use of a fireplace or surround, soft wall coverings such as wallpaper, blown vinyl etc. could be affected by the heat and may discolour or scorch. This should be considered when installing or decorating.

The Model number of this appliance is FCFL\*\*RN3 and it is manufactured by :-

\*\* denotes trim and colour variant

BFM Europe Ltd.  
Trentham Lakes  
Stoke-on-Trent  
Staffordshire  
ST4 4TJ

## ABOUT YOUR NEW ROCCO ROOM HEATER

The Flavel Rocco decorative fuel effect room heater incorporates a unique and highly developed fuel bed which gives the realism of a loose log layout combined with realistic flames and glow. The use of durable hard ceramic material in the construction of the fuelbed components ensures long and trouble free operation. When first using the new fire a slight smell may be noticed. This is due to small deposits of oil on the firebox, but will soon disappear. Please take the time to fully read these instructions as you will then be able to obtain the most effective and safe operation of your fire.

**DO NOT UNDER ANY CIRCUMSTANCES ATTEMPT TO USE THIS APPLIANCE IF THE GLASS PANEL IS BROKEN OR HAS BEEN REMOVED.**

### IMPORTANT SAFETY INFORMATION

**WARNING : This appliance has a hot surface and as with all heating appliances a fireguard should be used for the protection of children, the elderly and infirm. Fireguards should conform to B.S. 8423 : 2002 (Fireguards for use with gas heating appliances). Servicing should be carried out annually by a competent person such as a GAS SAFE registered engineer. It is a condition of BFM Europe Ltd. lifetime guarantees schemes that this is carried out by a competent person i.e a GAS SAFE registered Engineer.**

The service should include visually checking the appliance, flue terminal and fireplace for accumulation of debris around the firebox, and inspection of the ceramic logs, replacing as necessary. Should debris be found upon the fuel-bed, please contact a GAS SAFE registered installer. The condition of the ceramic log set should be carefully checked and **if necessary the whole unit should be replaced with a genuine replacement set.**

**After any servicing work a gas tightness check must always be carried out.** Any debris or deposits should be removed from the log set from time to time. This may be carried out by referring to the cleaning section as described later in this book. Only the fuelbed components as supplied must be used and complete and genuine replacements must be used. Always keep furniture and combustible materials well clear of the fire and never dry clothing or items either on or near to the fire. Never use aerosols or flammable cleaning products near to the fire when it is in use.

### SPILLAGE MONITORING SYSTEM

This appliance is fitted with a spillage monitoring system which shuts down the fire if the evacuation of combustion products from the fire is affected by a partially or fully blocked flue pipe. If this system operates the fire will go out. If this occurs, leave the fire for at least three minutes then follow the lighting procedure as described in the previous section.

**In the event of repeated operation a GAS SAFE registered gas installer must be called to investigate and rectify the cause.**

**The fuel bed remains hot for a considerable period after use and sufficient time should be allowed for the fire to cool before cleaning etc.**

**The fire must only be operated with the trim as supplied, in position.**

## **OPERATING THE FIRE**

This appliance is designed so the pilot burner runs constantly, and the remote control handset is used to operate the main burner only. The remote control can not be used to light the pilot burner. The pilot burner control and main gas valve are located behind the trim, to remove the trim, see page 13 for details.

The control valve features two control knobs, the left hand one to light the pilot, and the right hand one to adjust the heat input to the appliance from high (6.9kW) to low (3.5kW). Fig. 1 below shows the control valve.

**Fig. 1**

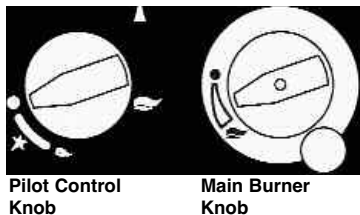

### **Lighting the Pilot**

To light the pilot, press the knob in and turn it anticlockwise. (It may be necessary to hold the control knob in for a few seconds to purge air from the pipe). Once gas is available at the pilot, by turning the control knob further anticlockwise the piezo igniter will cause a spark at the pilot to light the pilot burner. Once the pilot burner is lit, hold the control knob depressed for approximately 10 seconds to hold the flame supervision device in. Let the control knob go and the pilot should remain lit, if the pilot goes out repeat the lighting sequence. Turn the control knob to the large flame position, this will allow gas to the main burner section of the control valve.

### **Extinguishing the Pilot**

The pilot flame can be extinguished by turning the left hand control knob clockwise to the position marked ●. This product is designed to have the pilot burner running continuously, therefore giving full operational control via the remote handset when the pilot burner is running continuously.

### **Lighting the Main Burner (Manually)**

The right hand control knob will be in the off position, denoted by ●. No gas can enter the main burner until this control knob is turned anticlockwise. When this knob is turned anti-clockwise, the main burner will light. The heat input can then be adjusted to any level between maximum heat input (6.9kW) and minimum heat input (3.5kW).

## **Lighting the Main Burner (via the Remote Handset)**

With the pilot burner established it is possible to light the main burner and adjust the gas rate between high and low with the remote control handset.

Press the “up” button to light the main burner and adjust the heat input to the maximum setting. (6.9kW heat input). Press the “down” button to reduce the heat input to the minimum setting (3.5kW heat input). See Fig. 2 below. If you press and hold the “down” button it will reduce the heat input to the minimum (3.5kW heat input) setting, if you keep the button depressed it will turn the main burner off at this point a clicking noise will be heard from the motor.

**Fig. 2**



If the remote does not work, first check the LED in the top left hand corner is illuminating when the button is pressed. If it does not illuminate, change the battery in the handset.

**NOTE :** The remote control does not light the pilot, it only lights the main burner when the pilot flame is established and regulates the heat input between high and low. If the remote is lost or broken, the fire can still be operated manually, see previous page for details.

**IMPORTANT :** IF THE BURNER IS EXTINGUISHED FOR ANY REASON YOU MUST ENSURE THAT YOU WAIT A FULL FIVE MINUTES BEFORE ATTEMPTING TO RE-LIGHT THE FIRE.

**NOTE : THIS APPLIANCE IS DESIGNED TO WORK SAFELY AND EFFECTIVELY DURING ADVERSE WEATHER CONDITIONS. HOWEVER, DURING SUCH TIMES FLAME DISTURBANCE MAY BE NOTICED. THIS IS NORMAL AND DOES NOT EFFECT OR IMPAIR THE SAFETY OF THE APPLIANCE.**

## **CLEANING**

**WARNING :** Before attempting any cleaning operation ensure that the fire has been allowed to fully cool.

### **CLEANING THE TRIM AND PAINTED METAL PARTS**

The extruded aluminium trim that is supplied for use with this product must be gently cleaned with a damp cloth only. **Abrasive cleaners, chemical cleaning agents or any type of polish must never be used as damage to the paint may result.**

### **CLEANING THE FUEL BED**

We do not recommend cleaning the fuelbed other than at annual service intervals. If carbon or soot accumulates on the logs, this should be removed by carefully brushing the fuelbed using a soft brush. For instructions on how to remove the glass panel please see page 7. **The log set is made from a form of refractory ceramic fibre and should be handled carefully to avoid generating dust, as this may be harmful if inhaled. As with some fibrous materials, handling fibrous materials without gloves could cause skin irritation.**

**The fuelbed should never be washed or exposed to any cleaning agents or water.**

Any damaged parts must be replaced by contacting your dealer, whose details may be found on the BFM Europe website, address on the rear page. The log set must only be replaced with a genuine replacement and the fire must never be run with a different log set fitted.

The log set must be carefully reassembled as stated in pages 8-12.

## CLEANING THE GLASS PANEL

To clean the glass panel, first ensure that the fire is cool, **please note that the glass panel will remain hot for a considerable period when the fire has been switched off.**

To remove the glass panel, follow the instructions below for removal and re-fitting. The glass panel should be cleaned gently with a soft damp cloth and glass cleaner.

**DO NOT UNDER ANY CIRCUMSTANCES ATTEMPT TO CLEAN THE GLASS PANEL WHEN THE APPLIANCE IS RUNNING.**

Fig. 3

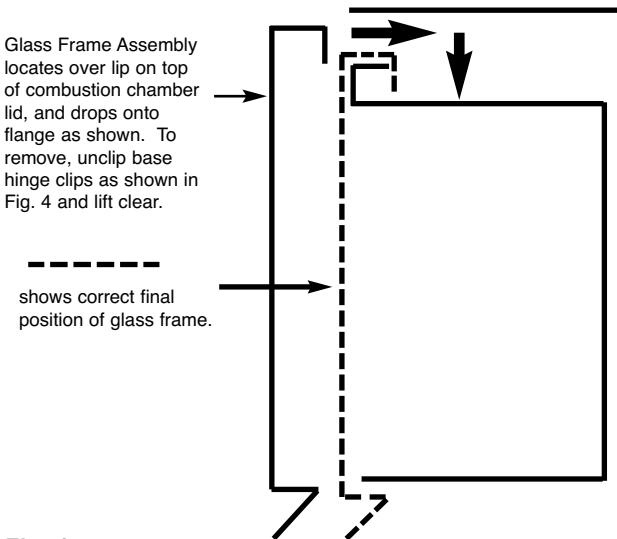
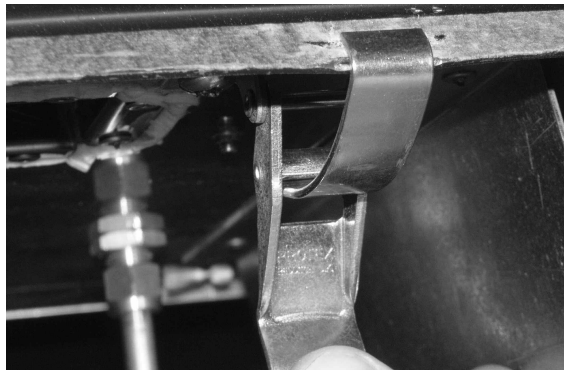

Fig. 4



## REMOVAL & RE-FITTING OF THE FUEL-BED LOGSET

- a) The gravel material should then be first layed around the base of the combustion chamber as shown below in Fig. 5, leaving the rear section as shown to allow the fitting of Log “A”

**Fig. 5**



- b) Place the largest Log “A” centrally onto the fuel-bed support behind the burner flame strip. Ensure that the fuel-bed Log “A” is located centrally in the firebox, and that the front edge is parallel with the rear face of the burner flame strip as shown below in Fig. 6

**Fig. 6**

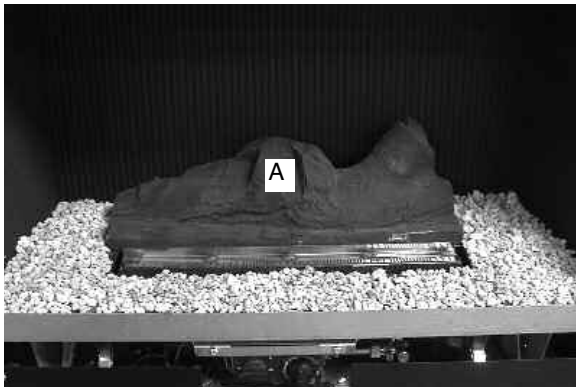



- c) Fit Log “B” into position on left hand side of the fuel-bed base log “A” as shown below in Fig. 7 using the groove in Log “A” as a guide for placement.

**Fig. 7**



- d) Fit Log “C” into position on left hand side of the fuel-bed base log “A” as shown below in Fig. 8, using the groove in Log “A” as a guide for placement.

**Fig. 8**



- d) Fit Log “D” into position on left hand side of the fuel-bed base log “A” as shown below in Fig. 9, using the groove in Log “A” as a guide for placement.

**Fig. 9**

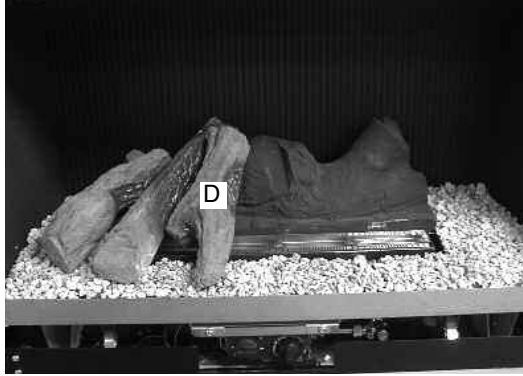

- e) Fit Log “E” into position at centre of the fuel-bed base log “A” as shown below in Fig. 10, using the groove in the centre of Log “A” as a guide for placement.

**Fig. 10**

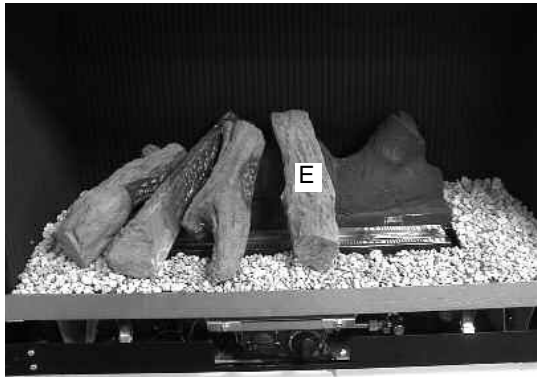

- f) Fit Log “F” into position at right hand side of centre of the fuel-bed base log “A” as shown below in Fig. 11, using the groove in Log “A” as a guide for placement.

**Fig. 11**

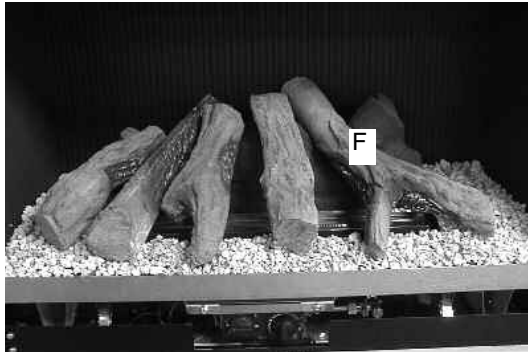

- g) Fit Log “G” into position at right hand side of the fuel-bed base log “A” as shown below in Fig. 12, using the raised section in the base log as a guide for position.

**Fig. 12**



### **IMPORTANT NOTE**

**HAVING FITTED THE GRAVEL MATERIAL IN THE BASE OF THE COMBUSTION CHAMBER, ENSURE THAT NONE OF IT IS ON THE BURNER FLAME STRIP OR IN THE PILOT ASSEMBLY. IF MATERIAL IS OBSERVED VISUALLY ON THESE COMPONENTS, REMOVE THE FUEL-BED LOGSET, REMOVE THE GRAVEL MATERIAL FROM THE BURNER AND OR PILOT AND RE-FIT THE LOGS AS DETAILED IN ABOVE.**

**Warning : Use only the logs supplied with the fire. When replacing the logs remove the old logs and discard them. Fit a complete set of logs of the correct type. Do not fit additional logs or any logs other than a genuine replacement set.**

This appliance uses fuel effect pieces containing Refractory Ceramic Fibres (R.C.F.), which are man-made vitreous silicate fibres. Excessive exposure to these materials may cause temporary irritation to eyes, skin and respiratory tract. Consequently, it makes sense to take care when handling these articles to ensure that the release of dust is kept to a minimum. To ensure that the release of fibres from these R.C.F. articles is kept to a minimum, during installation & servicing we recommend that you use a HEPA filtered vacuum to remove any dust and soot accumulated in and around the fire, before and after working on the fire. When replacing these articles we recommend that the replaced items are not broken up, but are sealed within a heavy duty polythene bag, clearly labelled as "RCF waste". This is not classified as "hazardous waste" and may be disposed of at a tipping site licensed for the disposal of industrial waste. Protective clothing is not required when handling these articles, but we do recommend you follow the normal hygiene rules of not smoking, eating or drinking in the work area, and always wash your hands before eating or drinking.

**This appliance does not contain any component manufactured from asbestos or asbestos related products.**

## REMOVAL & RE-FITTING OF THE TRIM ASSEMBLY

**IMPORTANT NOTE : The trim assembly of this product is a working surface and as such will become hot in use. Allow the product and trim to fully cool prior to attempting to remove it.**

- a) The aluminium trim is attached to the lid of the combustion chamber by hooking the retaining lip on the rear face of the trim assembly over the top of the combustion chamber lid as shown below in Fig. 13 & 14.

Fig. 13

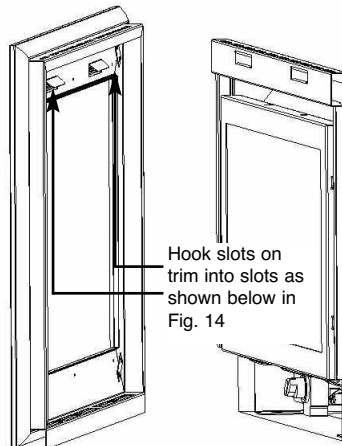
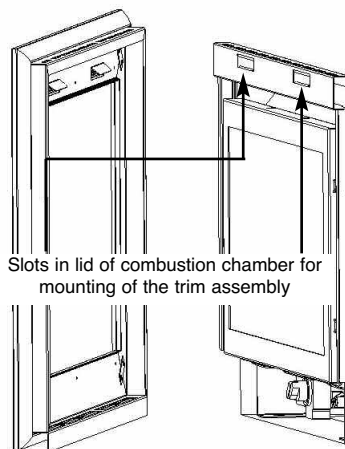

Fig. 14



## **USER REPLACEABLE PARTS**

The only user replaceable parts on this fire are the fuelbed / log form, and the handset / ultrasonic receiver batteries, which may be replaced as described in the section overpage. Replacement of any other parts must be carried out by a competent person such as a GAS SAFE registered gas installer.

The part numbers of the user replaceable parts are as follows, these are available from specialist spares stockists whose details can be found on our web site, [www.bfm-europe.com](http://www.bfm-europe.com), in the 'stockist' section.

Log Set B-109780

## **REPLACING THE BATTERIES IN THE HANDSET**

- a) Remove the old 9V battery by removing the cover on the back of the handset.
- b) Refit new battery and replace cover.

**Due to our policy of continual improvement and development the exact accuracy of descriptions and illustrations cannot be guaranteed**

**Part No. B-129320  
Issue 1**



BFM Europe Ltd.  
Trentham Lakes  
Stoke-on-Trent  
Staffordshire  
ST4 4TJ

[www.bfm-europe.com](http://www.bfm-europe.com)

**Telephone - General Enquiries :**  
**Telephone - Service :**

**(01782) 339000**  
**(0844) 7700169**