

WARNING BFM Europe Limited is a Gas Safe Register company. We recommend that all of our fires are installed by Gas Safe Register engineers in accordance with our instructions.

DISCLAIMER Our policy is one of constant development and improvement. We therefore reserve the right to revise designs and specifications of our products without formal notice, patents pending.

Whilst we have taken every care in the preparation of this brochure it is not intended to replace the installation manual which provides more detailed information. Photography is for illustration purposes only and although every effort has been made to ensure accurate reproduction of typical installations and flame pictures they may vary according to fire model and flue types.

We accept no liability for any loss or damage arising directly or indirectly from the use of this brochure.

We recommend that all our fires are used in conjunction with central heating and not as a primary source of heat.

In the interests of personal safety a suitable fireguard is recommended when children, the elderly and the infirm are present.

(This brochure is copyright 2010 and must not be reproduced in whole or in any part without prior written permission.)

Issue No. 24

We would like to thank Kedleston Heating (01332 200303), Olde England Reproductions (01782 319350) and Stanningley Firesides (0113 257 1512) for contributing fire surrounds to this brochure.



**MADE
IN BRITAIN**



Makes anywhere feel like home

BFM Europe Limited, Trentham Lakes, Stoke-on-Trent, Staffordshire ST4 4TJ.
Tel: 01782 339000. Fax: 01782 339009. www.bfm-europe.com e-mail: info@bfm-europe.com



Makes anywhere feel like home

GAS FIRES 2010/11





Makes anywhere feel like home

Welcome to Flavel

At Flavel we know how important it is to create a stylish and relaxing living environment. That's why we've developed this collection of affordable gas fires to complement all tastes and lifestyles. I believe our success stems from a combination of innovative design, investment in technology and the highest quality manufacturing standards. As a result all Flavel gas fires carry a 3 year guarantee to reflect my belief in their quality and durability.

This brochure has been designed to make the purchase of your new Flavel gas fire as simple as possible. I hope you will find it both informative and inspiring.



Every model carries the peace of mind of a 3 year guarantee, and the reassurance of the Flavel Airwatch System on all living flame effect fires. This device immediately cuts off the gas supply in the unlikely event of the flame being extinguished through blockage.

Our 3 Year Guarantee is subject to terms & conditions including annual services carried out by a Gas Safe Register engineer and annual replacement of the oxy-pilot assembly.



Today BFM Europe is the fastest growing domestic fire producer in the country with an unequalled reputation for quality and service. Every Flavel branded gas fire is developed and manufactured in Britain at our purpose built, state-of-the-art facility in Stoke-on-Trent.

What's your style?

high efficiency

Warm your home efficiently & beautifully. Our high efficiency fires use less energy, so you can save on those fuel bills!

Pages 6 - 14



The Caress HE - Page 7

Hole-in-the-wall

Distinctive, modern & different. Completely change your living space with a fire set within the wall.

Pages 15 - 20



The Rocco - Page 18

Slimline

Make a contemporary twist on the traditional fireplace. The versatile slimline range will fit almost any chimney or flue.

Pages 21-28



The Windsor Contemporary - Page 23

Full Depth

Our full depth fire range combines brilliant flame effects with outstanding heat output for maximum effect.

Pages 29 - 35



The Richmond - Page 29

Outset

Highly efficient radiant fire range, designed to suit your needs & stylish design tastes.

Pages 36 - 44



The Strata - Page 42

Contents

Choosing the right type of fire	2
Guide to symbols	4
HE fires	5
The Diamond HE	6
The Caress HE	7
The Kenilworth HE	8
The Linear HE	9
The Windsor Traditional HE	10
The Windsor Contemporary HE	11
The Raglan	12
The Orchestra	13
The Calibre	14
The Vesta	15
The Finesse	16
The Curve	17
The Rocco	18
The Jazz	19
The Pure	20
The Windsor Classic	21
The Windsor Traditional	22
The Windsor Contemporary	23
The Stirling	24
The Warwick	25
The Caress Slimline	26
The Melody	27
The Atlanta	28
The Richmond	29
The Waverley	30
The Caress	31
The Calypso	32
The Rhapsody	33
The Linear	34
The Kenilworth	35
The Renoir	36
The Emberglow	37
The Regent	38
The Regent LFE	39
The Firenze	40
The Welcome	41
The Strata	42
The Misermatic	43
The Renaissance	44
The Thurcroft Portable Stove	45
Sizes and Dimensions	46
Builders' Opening Sizes	47

Before you begin

Type of Chimney or Flue

The type of chimney or flue you have dictates the type of fire you can have. But if you're not sure, then take a look at your roof and compare it with the simple guide below. It's worth remembering that a full depth fire often requires a traditional chimney or rebate on the fire surround, whilst a slimline fire will fit virtually any chimney or flue.



Brick Chimney

Apart from products designed for "no chimney" applications, all Flavel products will fit brick chimneys. They are easily recognisable by a chimney stack with accompanying terracotta pot or gas terminal.



Pre-Fabricated Flue

Pre-fabricated flues are easily identifiable by a metal flue and terminal on the roof and a metal flue box behind the fire.



Pre-Cast Flue

Pre-cast flues can be identified by a ridge vent or metal flue tube and terminal on the roof. Constructed from concrete or clay blocks they form a rectangular section flue. All Flavel fires featuring this icon are only suitable for Pre-Cast flues conforming to BS EN 1858.

Controls



Manual Control

A simple and discreet control system located behind the fire's trim or fret on inset fires and the bottom right side on outlets.



Slide Control

Convenient control that eliminates the necessity of bending down.



Top Control

A push down and twist ignition and control located on the top of outset fires means you don't have to bend down to light the fire.



Semi Remote Control

Light the fire using the manual control system then use the remote control handset to adjust the flame height and heat output.



Fully Remote Control

The remote control handset is used to light the fire as well as adjust the flame height and heat output.



New Electronic Top or Side Control System

Both ignition and heat are controlled by a single rotary motion to light the fire. These easy to use controls are now available on our best selling radiant outlets. Requires AA batteries.

Can't see a Chimney or Flue?

If you can't see a chimney or flue like the ones described above, then you will require either a Balanced Flue, a Powerflue or an electric fire.



Powerflue

Powerflue fires use an electronically driven fan unit mounted on the external wall to expel the flue gases directly outside the building.



Balanced Flue

Balanced Flue fires use a horizontal pipe to vent directly outside. An electricity supply is not required for Balanced Flue products.

Power Supply

Your gas supply will either be natural gas or LPG, depending on the area in which you live.



Natural Gas

If you have a gas meter then you will have natural gas



LPG

LPG is the most popular alternative to natural gas

high efficiency

Get up to 94% net efficiency from your gas fire...

Flavel has always had a reputation as a manufacturer of some of the most efficient fires on the market. Now we have set new industry standards with the introduction of the Flavel HE high efficiency range: exceptional heat output combined with lower running costs compared to standard gas fires.

Flavel's R&D team has invested in developing the technology to meet the key objective of producing gas fires that save energy and as a result, help to keep costs down.



Hole-in-the-wall Fires



The Diamond HE - Page 6
78% net efficiency



Inset Fires



Conventional flue

The Caress HE

- Page 7

The Windsor HE

- Page 10 & 11

89% net efficiency

The Kenilworth HE

- Page 8

The Linear HE

- Page 9

78% net efficiency

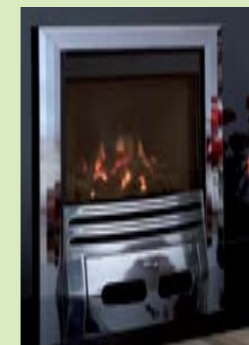

Balanced flue

The Calibre

- Page 14

94% net efficiency

The Raglan

- Page 12

The Orchestra

- Page 13

80% net efficiency



Outset Fires



LFE Convector

The Renoir

- Page 36

The Emberglow

- Page 37

78% net efficiency



Radiant

The Strata

- Page 42

The Misermatic

- Page 43

The Renaissance

- Page 44

84% net efficiency



high efficiency

As Flavel's debut high efficiency hole-in-the-wall fire, the Diamond HE is a contemporary and economical heating solution with a net efficiency of 78%. This fully glass fronted model features the stunning 'Diamond' fascia design and is available with a choice of coal or pebble fuel bed.



The Diamond HE with pebble fuel bed



The Diamond HE with coal fuel bed



The Caress HE Traditional in solid brass



high efficiency

The Caress HE is the first model in the Flavel 'high efficiency' range and has an incredible 89% net efficiency combined with a 4kW heat output. This glass fronted product comes with a high quality trim and fret, and is available with a choice of Traditional or Contemporary look. Both versions are available in either brass or polished cast iron with the option to choose manual, slide or remote control.



The Caress HE Contemporary in polished cast iron



Natural Gas



Brick Chimney



Pre-Fabricated



Plain Back



Fully Remote Control

The Diamond HE

Living Flame Effect - Hole-in-the-wall

Safety
Flame Supervision Device

Type of heat
Radiant & Convected

Heat input - high	4.5kW
Heat input - low	3.5kW
Heat output - high	3.2kW
Heat output - low	2.4kW

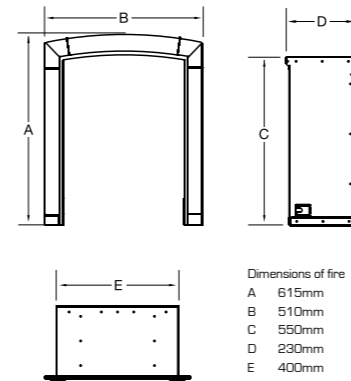
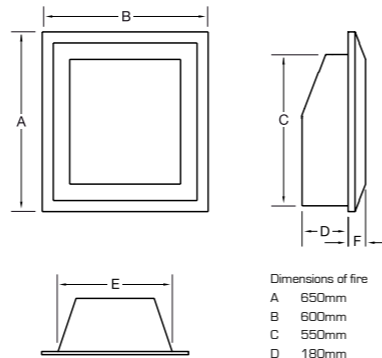

The Caress HE

Living Flame Effect
- Full Depth Inset Convector

Safety
Flame Supervision Device & Airwatch System

Type of heat
Radiant & Convected

Heat input - high	5kW
Heat input - low	3.5kW
Heat output - high	4kW
Heat output - low	1.8kW



Natural Gas



Brick Chimney



Pre-Fabricated



Plain Back



Manual Control



Slide Control



Fully Remote Control



high efficiency

The Kenilworth HE offers an impressive 78% net efficiency and is designed to fit most chimney and flue types.



The Kenilworth with black trim and Balmoral fret



The Kenilworth with brass trim and Grace fret



The Kenilworth with silver trim and Grace fret



The Kenilworth with brass trim and Balmoral fret



The Linear HE with coal fuel bed



high efficiency

The Linear HE has a net efficiency of up to 78% and is styled on our popular Linear design combining a modern, minimalist Stainless Steel fascia with ribbed back panel detail. This model is available with a choice of coal or pebble fuel bed.



Linear HE with pebble fuel bed

The Kenilworth HE

Living Flame Effect
- Full Depth Inset Convector

Safety
Flame Supervision Device

Type of heat
Radiant & Convected

Heat input - high	4.5kW
Heat input - low	3.5kW
Heat output - high	3.2kW
Heat output - low	2.4kW

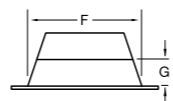
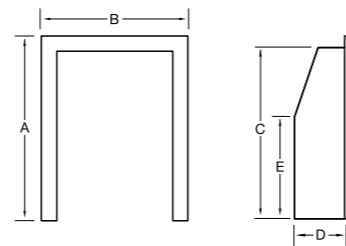

Dimensions of fire
 A 595mm
 B 500mm
 C 550mm
 D 180mm
 E 327mm
 F 365mm
 G 110mm

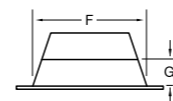
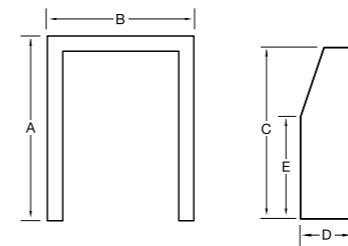

Dimensions of fire
 A 594mm
 B 485mm
 C 550mm
 D 180mm
 E 327mm
 F 365mm
 G 110mm

The Linear HE

Living Flame Effect
- Full Depth Inset Convector

Safety
Flame Supervision Device

Type of heat
Radiant & Convected

Heat input - high	4.5kW
Heat input - low	3.5kW
Heat output - high	3.2kW
Heat output - low	2.4kW

- Natural Gas
- Brick Chimney
- Pre-Fabricated (BS EN 1858)
- Pre-Cast (BS EN 1858)
- Plain Back
- Manual Control
- Fully Remote Control

- Natural Gas
- Brick Chimney
- Pre-Fabricated (BS EN 1858)
- Pre-Cast (BS EN 1858)
- Ribbed Back
- Manual Control



high efficiency

This slimline high efficiency fire boasts an incredible 89% net efficiency and will fit almost any chimney or flue, including Pre-Cast (BS EN 1858).

It also features a large viewing window and maximum heat output of up to 3.2kW.



The Windsor Traditional HE in silver



The Windsor Traditional HE in brass



The Windsor Contemporary HE



high efficiency

This slimline high efficiency fire boasts an incredible 89% net efficiency and will fit almost any chimney or flue, including Pre-Cast (BS EN 1858).

It also features a large viewing window and maximum heat output of up to 3.2kW.



Windsor HE Contemporary with pebble fuel bed

The Windsor Traditional HE Living Flame Effect - Slimline Inset Convector

Safety
Flame Supervision Device & Airwatch System

Type of heat
Radiant & Convected

Heat input - high	4.0kW
Heat input - low	2.0kW
Heat output - high	3.2kW
Heat output - low	1.4kW

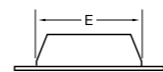
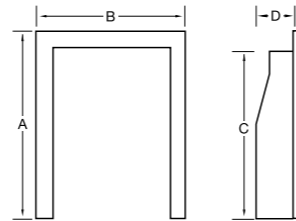

Dimensions of fire

A	592mm
B	475mm
C	550mm
D	125mm
E	327mm

The Windsor Contemporary HE Living Flame Effect - Slimline Inset Convector

Safety
Airwatch System

Type of heat
Radiant & Convected

Heat input - high	4.0kW
Heat input - low	2.0kW
Heat output - high	3.2kW
Heat output - low	1.4kW

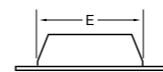
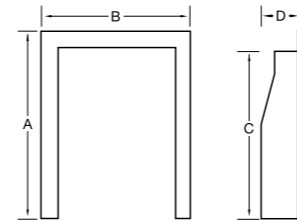

Dimensions of fire

A	592mm
B	475mm
C	550mm
D	125mm
E	327mm

- Natural Gas
- Brick Chimney
- Pre-Fabricated (BS EN 1858)
- Pre-Cast (BS EN 1858)
- Plain Back
- Manual Control
- Slide Control

- Natural Gas
- Brick Chimney
- Pre-Fabricated (BS EN 1858)
- Pre-Cast (BS EN 1858)
- Plain Back
- Manual Control



high efficiency

With a net efficiency of 80% the stylish Raglan Balanced Flue is designed to fit into houses without a chimney or flue and its glass front does more than simply look great... it increases efficiency too.



The Raglan in silver



The Raglan with brass trim and Blenheim brass fret



The Orchestra with silver trim and Royale silver and black fret



high efficiency

If you want the warmth and mood created by a living flame fire yet don't have a chimney or flue, then the Orchestra is the perfect solution. This neat, glass fronted inset fire with a net efficiency of 80% is framed by a chamfered trim and sleek fret.



The Orchestra with brass trim and Royale antique fret



Natural Gas



Balanced Flue



Plain Back



Manual Control

The Raglan BF

Living Flame Effect
- Slimline Inset Balanced Flue

Safety
Flame Supervision Device

Type of heat
Radiant & Convected

Heat input - high	3.8kW
Heat input - low	2.5kW
Heat output - high	2.8kW
Heat output - low	1.7kW

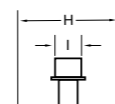
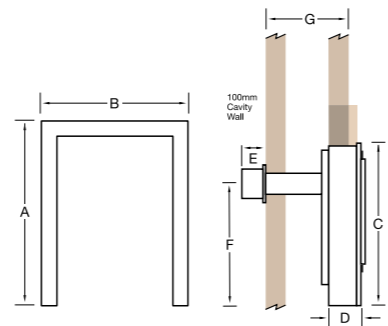

Dimensions of fire

A	620mm max
B	470mm min
C	580mm
D	125mm
E	95mm
F	435mm
G	675mm max - 130mm min
H	400mm
I	145mm

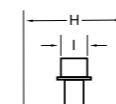
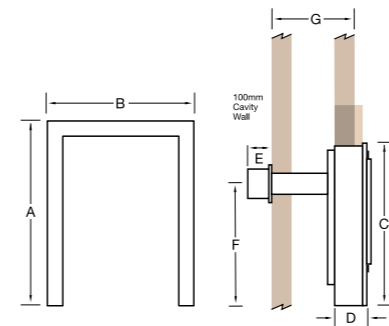

Dimensions of fire

A	620mm max
B	470mm min
C	580mm
D	125mm
E	95mm
F	435mm
G	675mm max - 130mm min
H	400mm
I	145mm

The Orchestra BF

Living Flame Effect
- Slimline Inset Balanced Flue

Safety
Flame Supervision Device

Type of heat
Radiant & Convected

Heat input - high	3.8kW
Heat input - low	2.5kW
Heat output - high	2.8kW
Heat output - low	1.7kW



Natural Gas



LPG



Balanced Flue



Plain Back



Manual Control



high efficiency

The Calibre Balanced Flue gas fire boasts efficiency of up to 94% and features a full depth coal fuel bed. This glass fronted fire has an exceptionally large viewing area and is available in a choice of brass or silver.



The Calibre BF in brass



The Calibre BF in silver



The Vesta with coal fuel bed

Specifically designed to fit a standard Pre-Cast flue this slimline hole-in-the-wall fire is highly contemporary with its reflective black and stainless steel fascia and a choice of manual or remote control operation. It offers a further choice of coal or pebble fuel bed.



The Vesta with pebble fuel bed



The Calibre BF

Living Flame Effect
- Full Depth Inset Balanced Flue

Safety
Flame Supervision Device

Type of heat
Radiant & Convected

Heat input - high 4.6kW
Heat input - low 3.0kW
Heat output - high 4.3kW

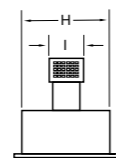
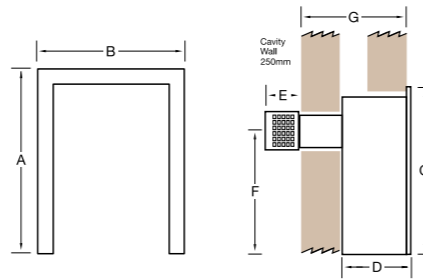

Dimensions of fire
A 595mm
B 500mm
C 551mm
D 185mm
E 200mm
F 423mm
G 615mm max - 285mm min
H 406mm min
I 150mm min

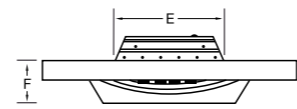
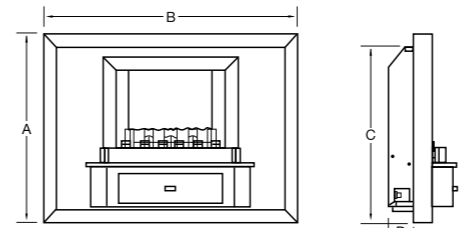

Dimensions of fire
A 559mm
B 753mm
C 487mm
D 75mm
E 320mm
F 128mm

The Vesta

Living Flame Effect
- Slimline Hole-in-the-wall

Safety
Flame Supervision Device & Airwatch System

Type of heat
Radiant

Heat input - high 6.5kW
Heat input - low 4.2kW
Heat output - high 3.6kW
Heat output - low 1.5kW

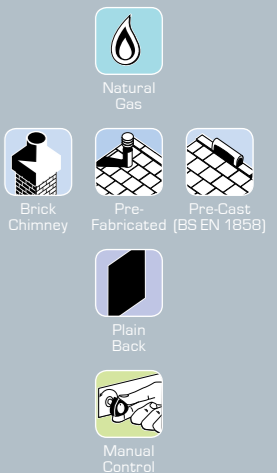

The most versatile hole-in-the-wall gas fire from Flavel. The Finesse will fit virtually any flue and is available in three different variations – a brass trim option to suit a classical setting and two chrome trim options for a more contemporary feel.



The Finesse with coal fuel bed and chrome trim



The Finesse with pebble fuel bed and chrome trim



The Finesse with coal fuel bed and brass trim



The Curve in Graphite



high efficiency

The Curve “hang-on-the-wall” fire with its sleek lines, textured fascia and glass front, complements the unique and complex flame pattern created by an undulating back panel. This stunning fire is easy to install as it literally hangs on the wall, rather than slotting into the structure.

The Curve is perfectly suited to contemporary homes requiring state-of-the-art appearance, 71% net efficiency and the performance to match.

The Finesse

Living Flame Effect
- Slimline Hole-in-the-wall

Safety
Flame Supervision Device & Airwatch System

Type of heat
Radiant

Heat input - high	6.5kW
Heat input - low	2.2kW
Heat output - high	3.3kW
Heat output - low	1.0kW

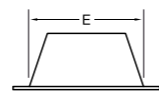
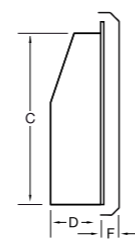
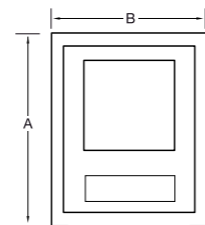

Dimensions of fire
A 690mm
B 558mm
C 550mm
D 120mm
E 329mm
F 50mm

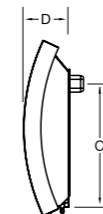
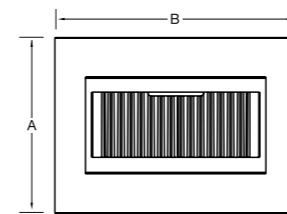

Dimensions of fire
A 635mm
B 870mm
C 445mm
D 166mm

The Curve

Living Flame Effect
- Hang-on-the-wall

Safety
Flame Supervision Device & Airwatch System

Type of heat
Radiant & Convected

Heat input - high	6.5kW
Heat input - low	4.2kW
Heat output - high	4.0kW
Heat output - low	1.5kW

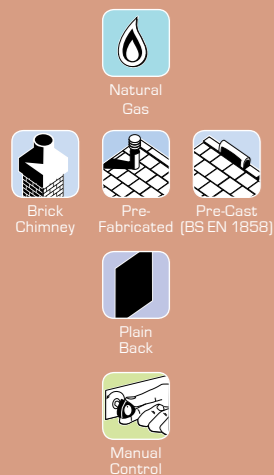

This stunning glass fronted hole-in-the-wall fire features a realistic log fuel bed and comes in a range of fascia and back panel colour combinations.



The Rocco black with black trim



The Rocco black with champagne trim



The Rocco cream with champagne trim

- Natural Gas
- Brick Chimney
- Pre-Fabricated
- Balanced Flue*
- Ribbed Back
- Semi Remote Control

*Only available on black back models with black or silver trim



The Rocco black with silver aluminium trim



The Jazz Black with black trim

This stunning glass fronted hole-in-the-wall fire has petite dimensions and a highly realistic log fuel bed. Jazz Black models come complete with high quality trims in four finishes – Silver, Champagne, Black or Jazz Impact. Jazz Cream comes complete with Champagne trim.



The Jazz Cream with silver trim



The Jazz Cream with champagne trim



The Jazz Impact

- Natural Gas
- Brick Chimney
- Pre-Fabricated
- Balanced Flue*
- Ribbed Back
- Semi Remote Control

*Only available on black back models with black or silver trim

The Rocco

Living Flame Effect – Hole-in-the-wall

Safety	Conventional Flue Flame Supervision Device & Airwatch System	Balanced Flue Flame Supervision Device
Type of heat	Radiant	Radiant & Convected
Heat input – high	6.9kW	7.5kW
Heat input – low	3.5kW	3.5kW
Heat output – high	3.9kW	5.5kW
Heat output – low	1.5kW	1.5kW

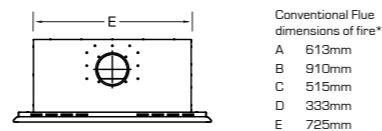
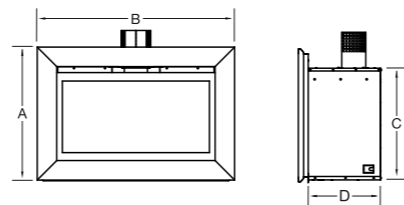

Conventional Flue dimensions of fire*
A 613mm
B 910mm
C 515mm
D 333mm
E 725mm

*Balanced flue dimensions may differ slightly from the conventional flue model. Always refer to the installation manual before completing any building work.

† Depth with spacer frame.

The Jazz

Living Flame Effect – Hole-in-the-wall

Safety	Conventional Flue Flame Supervision & Oxygen Depletion Sensor	Balanced Flue Flame Supervision Device
Type of heat	Radiant	Radiant & Convected
Heat input - high	5.5kW	5.5kW
Heat input - low	3.0kW	3.0kW
Heat output - high	3.0kW	4.2kW
Heat output - low	1.5kW	2.3kW

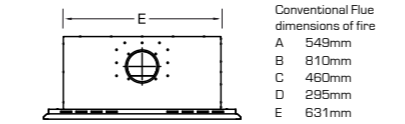
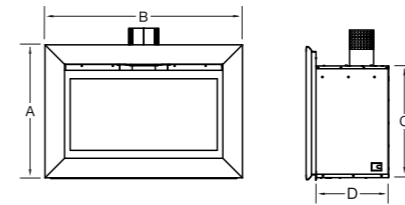

Conventional Flue dimensions of fire
A 549mm
B 810mm
C 460mm
D 295mm
E 631mm

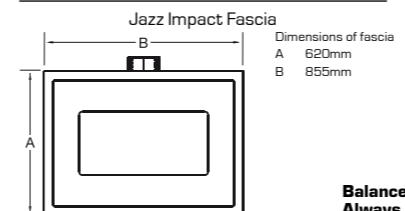

Jazz Impact Fascia
Dimensions of fascia
A 620mm
B 855mm

Balanced flue dimensions may differ slightly from the conventional flue model. Always refer to the installation manual before completing any building work.

These striking decorative flame effect fires come in a choice of Pure Black with silver fascia and reflective back panel or Pure Cream with champagne or rosé fascia and ribbed back panel. They are operated by a fully automatic remote control for ease of ignition.



The Pure Cream with rosé fascia



The Pure Black



The Pure Cream with champagne fascia



The Windsor Classic in brass



The popular and versatile Windsor range now includes a Classic model. Its clean lines ensure that it will fit beautifully into both traditional and contemporary homes. Featuring a coal fuel bed with a choice of brass or silver trim and fret. The Windsor Classic has a heat output of 3.3kW.



The Windsor Classic in silver



Natural Gas



Brick Chimney



Pre-Fabricated



Fully Remote Control

The Pure

Decorative Flame Effect - Hole-in-the-wall

Safety

Flame Supervision Device & Oxygen Depletion Sensor

Type of heat

Radiant

Heat input - high	6.9kW
Heat input - low	4.2kW
Heat output - high	Decorative flame effect only
Heat output - low	Decorative flame effect only

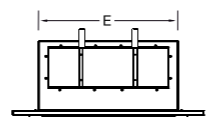
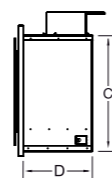
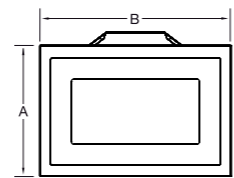

Dimensions of fire
 A 568mm
 B 828mm
 C 504mm
 D 300mm
 E 605mm

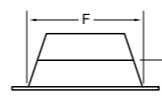
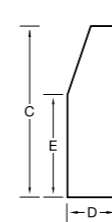
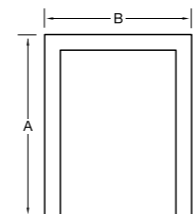

Dimensions of fire
 A 592mm
 B 475mm
 C 550mm
 D 120mm
 E 302mm
 F 329mm
 G 70mm

The Windsor Classic

Living Flame Effect - Slimline Inset Radiant

Safety

Flame Supervision Device & Airwatch Sensor

Type of heat

Radiant

Heat input - high	6.5kW
Heat input - low	2.2kW
Heat output - high	3.3kW
Heat output - low	1.0kW



Natural Gas



Brick Chimney



Pre-Fabricated



Pre-Cast [BS EN 1858]



Plain Back



Manual Control

If installing with a flue liner please consult the installation manual for dimensions.

With its authentic fuel bed and gently flickering flame, the Windsor is as warm and welcoming as any real coal fire. An optional brick-effect firebox adds to its cosy charm and it fits beautifully into all flue types including pre-cast, (BS EN 1858).



The Windsor Traditional with silver trim and fret



The Windsor Traditional with brass trim and fret



Windsor Contemporary Pebble and silver trim



Stunning styling makes the Windsor Contemporary the centrepiece of your room. It fits into any flue, including pre-cast (BS EN 1858), and features a range of fuel beds with a beautiful, natural flame.



Coal fuel bed with brass trim



Driftwood fuel bed with silver trim



Pebble fuel bed with brushed steel trim

The Windsor Traditional

Living Flame Effect - Slimline Inset Radiant

Safety
Flame Supervision Device & Airwatch System

Type of heat
Radiant

Heat input - high	6.5kW
Heat input - low	2.2kW
Heat output - high	3.3kW
Heat output - low	1.0kW

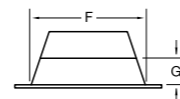
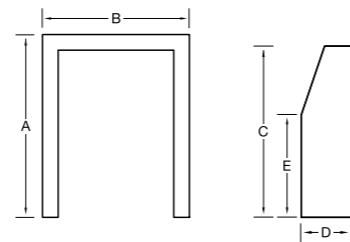

Dimensions of fire
A 592mm
B 475mm
C 550mm
D 120mm
E 302mm
F 329mm
G 70mm

The Windsor Contemporary

Living Flame Effect - Slimline Inset Radiant

Safety
Flame Supervision Device & Airwatch System

Type of heat
Radiant

Heat input - high	6.5kW
Heat input - low	2.2kW
Heat output - high	3.3kW
Heat output - low	1.0kW

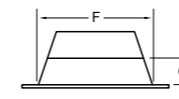
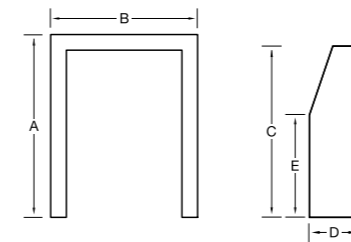

Dimensions of fire
A 592mm
B 475mm
C 550mm
D 120mm
E 302mm
F 329mm
G 70mm

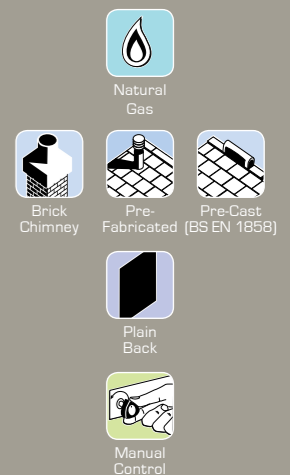

Slimline to fit into all flue types, with a very impressive heat output. And to ensure the Stirling suits all requirements, a slide control model is also available.



The Stirling with brass trim and Blenheim antique fret.



The Stirling with black trim and Blenheim black fret



The Warwick with brass trim and Balmoral brass fret

This ultra slim Warwick means it will fit almost any chimney or flue, and has an impressive 3.5kW heat output.



The Warwick with black trim and Balmoral black fret



The Warwick silver with Grace fret

The Stirling

Living Flame Effect - Slimline Inset Convector

Safety
Flame Supervision Device & Airwatch System

Type of heat
Radiant & Convected

Heat input - high	6.5kW
Heat input - low	4.2kW
Heat output - high	3.6kW
Heat output - low	1.5kW

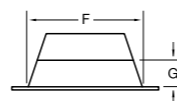
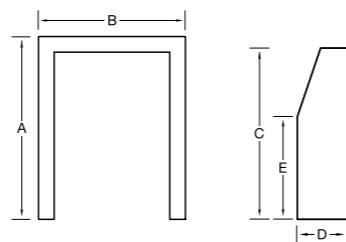

Dimensions of fire
A 595mm
B 500mm
C 550mm
D 125mm
E 350mm
F 322mm
G 90mm

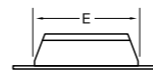
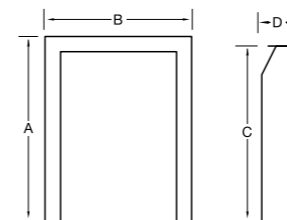

Dimensions of fire
A 595mm
B 500mm
C 550mm
D 100mm
E 325mm

The Warwick

Living Flame Effect - Slimline Inset Radiant

Safety
Flame Supervision Device & Airwatch System

Type of heat
Radiant

Heat input - high	6.5kW
Heat input - low	4.2kW
Heat output - high	3.3kW
Heat output - low	1.5kW

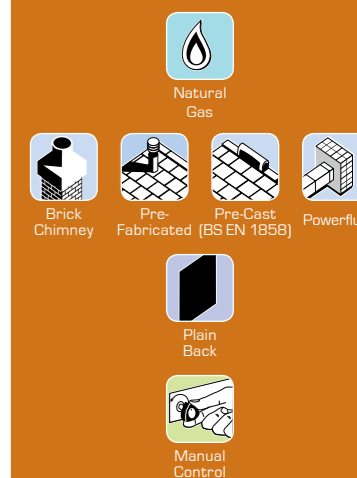

Featuring a high quality cast trim and fret, the Caress Traditional Slimline is a striking feature in homes where a full depth fire is not a suitable option. Manual control and slide control models are available.*

*Coal bed and flame picture differs between manual and slide control models



Caress Slimline slide control with polished cast iron trim and fret



Caress Slimline manual control with polished brass trim and fret



The Melody with silver trim and Royale silver and black fret

The Melody is an elegant slimline fire enabling installation in almost any flue including pre-cast. The discreet slide control ensures convenient operation with a heat output of up to 3.3kW.



The Melody with brass trim and Royale brass fret. Also available in black, and antique.

The Caress Slimline

Living Flame Effect - Slimline Inset Radiant

Safety
Flame Supervision Device & Airwatch System

Type of heat
Radiant

	Manual	Slide
Heat input - high	6.5kW	6.5kW
Heat input - low	2.2kW	4.2kW
Heat output - high	3.3kW	3.3kW
Heat output - low	1.0kW	1.6kW

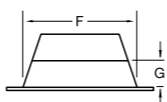
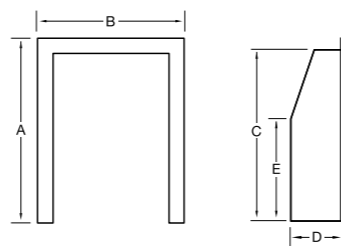

Dimensions of fire	
Manual Control	Slide Control
A 615mm	A 615mm
B 510mm	B 510mm
C 550mm	C 550mm
D 120mm	D 105mm
E 302mm	E 325mm
F 329mm	F 325mm
G 70mm	

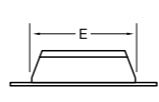
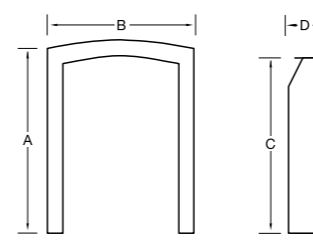

Dimensions of fire	
A	605mm
B	491mm
C	550mm
D	105mm
E	325mm

The Melody

Living Flame Effect - Slimline Inset Radiant

Safety
Flame Supervision Device

Type of heat
Radiant

Heat input - high	6.5kW
Heat input - low	4.2kW
Heat output - high	3.3kW
Heat output - low	1.6kW



Simplicity of form. Complexity of flame. The Atlanta's clean lines compliment its clean burning efficiency. The glass front amplifies a unique flame pattern through an undulating back panel and its sleek design ensures easier and cheaper installation. Offset against a brushed steel trim it conjures up an ethereal yet comforting minimalism.



This full depth convector fire combines a brilliant flame-effect with the efficiency and outstanding warmth of a 4kW heat output. Available in black, silver or brass, with manual, slide or remote control.



The Richmond with black trim and black fret



The Richmond with silver trim and silver fret

The Atlanta

Flame Pattern Effect - Slimline Inset Radiant

Safety
Flame Supervision Device

Type of heat
Radiant & Convected

	Conventional Flue	Balanced Flue high efficiency
Heat input - high	4.7kW	4kW
Heat input - low	2.5kW	2.5kW
Heat output - high	2.0kW	2.8kW
Heat output - low	1.5kW	1.7kW

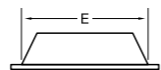
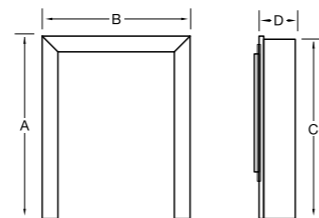

Dimensions of fire*
A 622mm
B 485mm
C 550mm
D 100mm
E 265mm

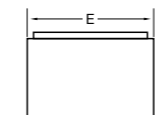
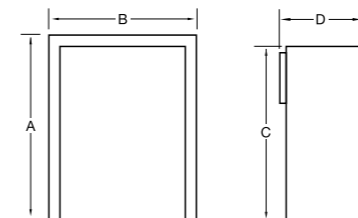

Dimensions of fire
A 595mm
B 500mm
C 550mm
D 250mm
E 400mm

The Richmond

Living Flame Effect - Full Depth Inset Convector

Safety
Flame Supervision Device & Airwatch System

Type of heat
Radiant & Convected

Heat input - high	6.9kW
Heat input - low	4.2kW
Heat output - high	4.0kW
Heat output - low	1.5kW

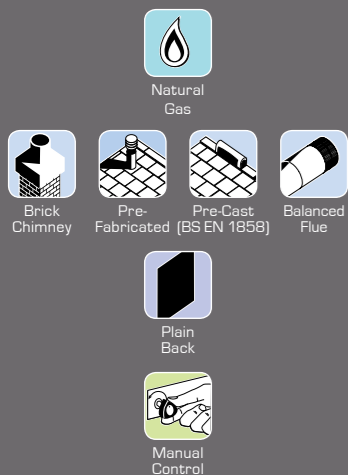
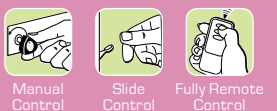

*See page 46 for Atlanta Balanced Flue model dimensions.

The Waverley, with its beautiful decorative flame effect, is a perfect replacement for a solid fuel grate. The 16" tapered inset tray is designed to fit a standard 16" fireback, providing a realistic coal effect for almost any style of fireplace.

Fret not included.



The Waverley inset tray shown with Bauhaus black fret



The Caress Contemporary in polished cast iron finish. Also available in brass.

The Caress is an open fronted full depth living flame effect convector fire which boasts an impressive 4kW heat output. The Contemporary model is available in a choice of brass or polished cast iron trim and fret, whilst the Traditional model comes in a choice of solid brass or polished cast iron. Both models offer manual, slide or remote control operation.



The Caress Traditional with solid brass trim and fret. Also available in polished cast iron.



Natural Gas



Brick Chimney



Pre-Fabricated



Manual Control

The Waverley

Decorative Flame Effect - Inset Tray

Safety

Flame Supervision Device & Airwatch System

Type of heat

Radiant

Heat input - high	6.9kW
Heat input - low	4.2kW
Heat output - high	2.0kW
Heat output - low	1.5kW

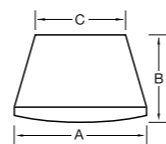

Dimensions of fire
A 350mm
B 205mm
C 230mm

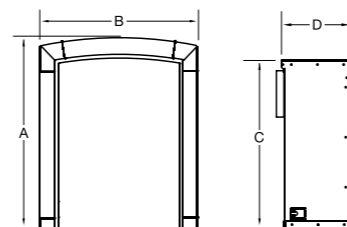

Dimensions of fire
A 615mm
B 510mm
C 550mm
D 250mm
E 400mm

The Caress Contemporary & Traditional

Living Flame Effect - Full Depth Inset Convector

Safety

Flame Supervision Device & Airwatch System

Type of heat

Radiant & Convected

Heat input - high	6.9kW
Heat input - low	4.2kW
Heat output - high	4.0kW
Heat output - low	1.5kW



Natural Gas



Brick Chimney



Pre-Fabricated



Plain Back



Manual Control



Slide Control



Fully Remote Control

Designed to fit standard 16" (400mm) chairbrick.

The Calypso successfully combines exceptional fire design with today's necessity for convenience in the form of a user friendly dual directional slide control. Add to this a full depth fuel bed for maximum effect and you have the perfect fire for modern living.



The Calypso with brass trim and Blenheim antique fret



The Rhapsody with brass trim and Royale brass fret

With its elegant arc trim and striking fret the Rhapsody is a classic. The full depth coal bed creates a beautiful flame picture and underglow, virtually indistinguishable from a real coal fire.



The Rhapsody with black trim and Royale black fret
Also available in silver or antique brass

The Calypso

Living Flame Effect
- Full Depth Inset Convector

Safety
Flame Supervision Device & Airwatch System

Type of heat
Radiant & Convected

Heat input - high	6.9kW
Heat input - low	4.2kW
Heat output - high	3.9kW
Heat output - low	1.7kW

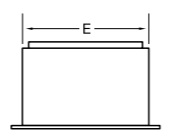
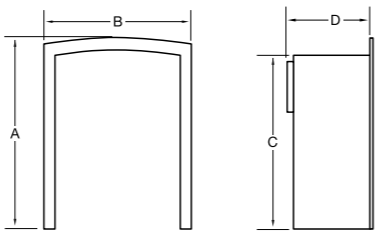

Dimensions of fire

A	605mm
B	491mm
C	549mm
D	254mm
E	400mm

The Rhapsody

Living Flame Effect
- Full Depth Inset Convector

Safety
Flame Supervision Device & Airwatch System



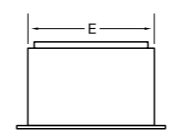
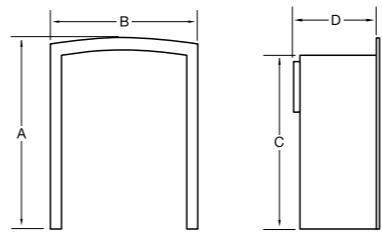

Type of heat
Radiant & Convected







Heat input - high	6.9kW
Heat input - low	4.2kW
Heat output - high	4.0kW
Heat output - low	1.7kW



Dimensions of fire

A	605mm
B	491mm
C	547mm
D	254mm
E	400mm

-  Natural Gas
-  Brick Chimney
-  Pre-Fabricated
-  Plain Back
-  Slide Control

-  Natural Gas
-  LPG
-  Brick Chimney
-  Pre-Fabricated
-  Plain Back
-  Slide Control

A stunning modern design with the combination of black ribbed back panels and stainless steel or brass fascia. Its full depth coal fuel bed offers a wonderful flickering glow and can fit into a pre-cast flue with a rebated surround.



The Linear coal with brass fascia



The Linear pebble with chrome fascia



The Linear coal with chrome fascia



The Kenilworth with black trim and Balmoral black fret

This full depth fire fits into a pre-cast flue with a 3" rebate on the fire surround. The 3.3kW heat output delivers generous warmth.



The Kenilworth with brass trim and Balmoral brass fret



The Kenilworth brass with Grace fret



The Kenilworth silver with Grace fret

The Linear

Living Flame Effect - Full Depth Inset Radiant

Safety
Flame Supervision Device & Airwatch System

Type of heat
Radiant

Heat input - high	6.9kW
Heat input - low	4.2kW
Heat output - high	3.3kW
Heat output - low	1.5kW

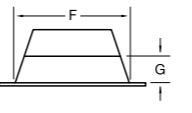
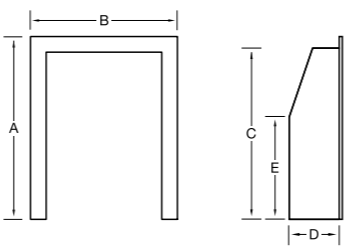

Dimensions of fire
A 594mm
B 485mm
C 550mm
D 170mm
E 327mm
F 365mm
G 110mm

The Kenilworth

Living Flame Effect - Full Depth Inset Radiant

Safety
Flame Supervision Device & Airwatch System

Type of heat
Radiant

Heat input - high	6.9kW
Heat input - low	4.2kW
Heat output - high	3.3kW
Heat output - low	1.5kW

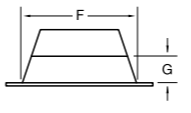
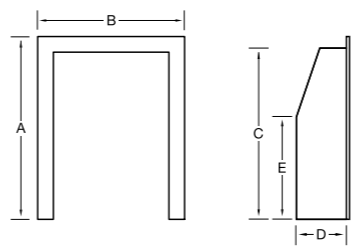

Dimensions of fire
A 595mm
B 500mm
C 550mm
D 170mm
E 327mm
F 365mm
G 110mm

Heat output figures stated above apply only to conventional flue models. For Balanced Flue dimensions see page 46.

Heat output figures stated above apply only to conventional flue. For Balanced Flue dimensions see page 46.

- Natural Gas
- Brick Chimney
- Pre-Fabricated (BS EN 1858)
- Pre-Cast (BS EN 1858)
- Powerflue
- Ribbed Back
- Manual Control

- Natural Gas
- Brick Chimney
- Pre-Fabricated (BS EN 1858)
- Pre-Cast (BS EN 1858)
- Powerflue†
- Plain Back
- Manual Control
- Fully Remote Control

†not available with remote control



high efficiency

The Renoir has a highly reliable burner, which means beautiful flickering flames and glowing coals. This traditional fire is 78% (net) efficient and is complemented by decorative brass effects.



The Renoir in bronze

COMING SOON



Electronic Side Control
Please ask your retailer for more details



The Renoir in black



The Renoir

Living Flame Effect - Outset Convector

Safety
Flame Supervision Device & Airwatch System

Type of heat
Radiant & Convected

Heat input - high	6.0kW
Heat input - low	1.8kW
Heat output - high	4.3kW
Heat output - low	1.0kW

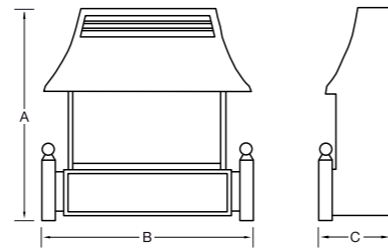

Dimensions of fire
A 703mm
B 684mm
C 324mm

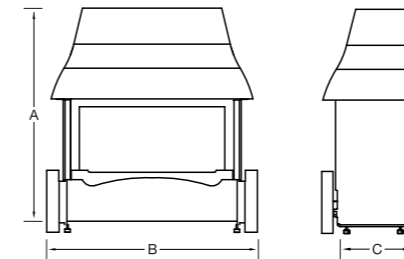

Dimensions of fire
A 706mm
B 673mm
C 324mm

The Emberglow

Living Flame Effect - Outset Convector

Safety
Flame Supervision Device & Airwatch System

Type of heat
Radiant & Convected

	Conventional Flue	Balanced Flue
Heat input - high	6.0kW	5.5kW
Heat input - low	1.8kW	2.1kW
Heat output - high	4.3kW	4.3kW
Heat output - low	1.0kW	1.2kW



high efficiency

This glass fronted convector fire has a 78% net efficiency and because it also offers a Balanced Flue* option, even those without a chimney can enjoy its charm. Incorporating the classical elegance of cast iron and side windows so flames can be seen from all angles.



Balanced flue model

COMING SOON



Electronic Side Control
Please ask your retailer for more details



Natural Gas



Brick Chimney



Pre-Fabricated



Pre-Cast



Plain Back



Manual Control



Fully Remote Control

*not available on Balanced Flue or Remote Control models

For Balanced Flue dimensions see page 46.



Natural Gas



LPG*



Brick Chimney



Pre-Fabricated



Pre-Cast



Balanced Flue



Plain Back



Manual Control



Fully Remote Control

One of the most popular radiant fires in the UK, The Regent LFE is slim for a neat fit and is highly efficient for lower running costs. It gives out radiated and convected heat and is an elegant interpretation of the Regency period.



The Regent LFE in bronze



The Regent LFE in black



The Regent in black

One of the most popular radiant fires in the UK, The Regent is slim for a neat fit and is highly efficient for lower running costs. It gives out radiated and convected heat and is an elegant interpretation of the Regency period.



The Regent in bronze

- Natural Gas
- Brick Chimney
- Pre-Fabricated (BS EN 1858)
- Pre-Cast (BS EN 1858)
- Plain Back
- Manual Control
- Fully Remote Control

The Regent LFE

Living Flame Effect - Outset Convectator

Safety
Flame Supervision Device & Airwatch System

Type of heat
Radiant & Convected

Heat input - high	6.0kW
Heat input - low	1.4kW
Heat output - high	3.2kW
Heat output - low	0.8kW

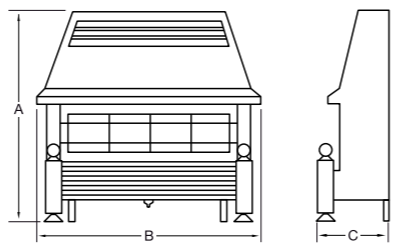

Dimensions of fire
A 680mm
B 710mm
C 255mm

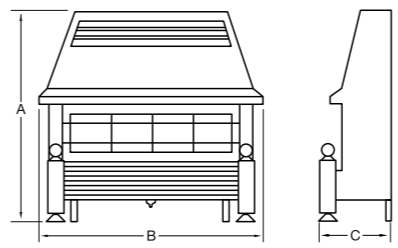

Dimensions of fire
A 680mm
B 710mm
C 255mm

The Regent

Radiant - Outset Convectator

Safety
Flame Supervision Device & Airwatch System

Type of heat
Radiant & Convected

Heat input - high	6.6kW
Heat input - low	1.2kW
Heat output - high	4.4kW
Heat output - low	0.6kW

- Natural Gas
- Brick Chimney
- Pre-Fabricated (BS EN 1858)
- Pre-Cast (BS EN 1858)
- Manual Control

The compact and economical Firenza can be wall or hearth mounted and has a control located on the top panel for ease of use.



The Firenza in black



The Firenza in bronze



The Welcome in bronze

The Welcome's beautiful electrically illuminated coal effect brings life to the room even when it is turned off, providing a charming focal point to any room. It is also highly efficient resulting in lower running costs.



The Welcome in black

The Firenza

Radiant - Outset Convector

Safety
Flame Supervision Device & Airwatch System

Type of heat
Radiant & Convected

Heat input - high	5.2kW
Heat input - low	1.2kW
Heat output - high	3.4kW
Heat output - low	0.6kW

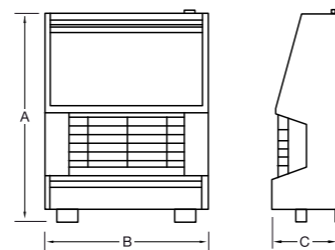

Dimensions of fire
A 659mm
B 506mm
C 222mm

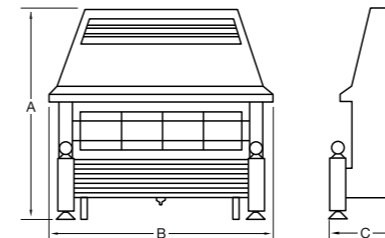

Dimensions of fire
A 680mm
B 718mm
C 310mm

The Welcome

Radiant - Outset Convector

Safety
Flame Supervision Device & Airwatch System

Type of heat
Radiant & Convected

Heat input - high	6.6kW
Heat input - low	1.2kW
Heat output - high	4.4kW
Heat output - low	0.8kW

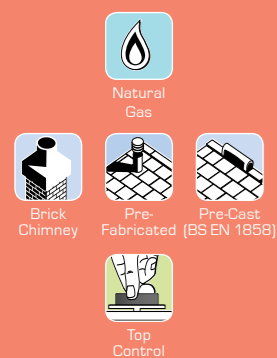

Top Control



Manual Control



high efficiency

The Strata offers an incredible net efficiency of 84% and 5.2kW heat output, and has a stylish contemporary look. Its soft, curved design offers a real alternative to most radiants and is available in black or brown finishes.



The Strata in black finish

New & Improved Electronic Top Control System

See page 4 for further details.



Natural Gas



Brick Chimney



Pre-Fabricated (BS EN 1858)



Pre-Cast (BS EN 1858)



Electronic Top Control

The Strata

Radiant - Outset Convector

Safety

Flame Supervision Device & Airwatch System

Type of heat

Radiant & Convected

Heat input - high	6.9kW
Heat input - low	2.5kW
Heat output - high	5.2kW
Heat output - low	1.0kW

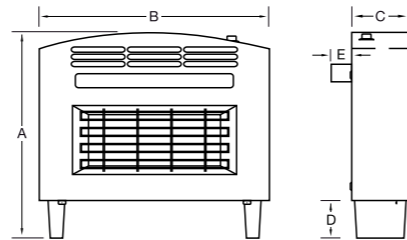

Dimensions of fire
 A 530mm
 B 715mm
 C 210mm
 D 100mm
 E 60mm

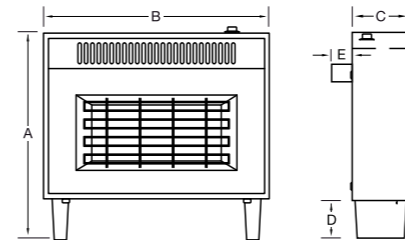

Dimensions of fire
 A 515mm
 B 800mm
 C 200mm
 D 100mm
 E 60mm

The Misermatic

Radiant - Outset Convector

Safety

Flame Supervision Device & Airwatch System

Type of heat

Radiant & Convected

Heat input - high	6.9kW
Heat input - low	2.5kW
Heat output - high	5.2kW
Heat output - low	1.0kW



high efficiency

Incredible 84% net efficiency and adaptability; the real wood-cased Misermatic has them both. Available in either teak or mahogany finish, this fire can be wall or hearth mounted and with easily accessible top-mounted controls, it represents the ideal choice for any number of interiors.



The Misermatic with mahogany finish

New & Improved Electronic Top Control System

See page 4 for further details.



Natural Gas



Brick Chimney



Pre-Fabricated (BS EN 1858)



Pre-Cast (BS EN 1858)



Electronic Top Control



high efficiency

The Renaissance provides a natural talking point the moment you enter the room. Its stylish retro design is matched by its forward thinking efficiency, simplicity of installation and impressive 5.2kW heat output.



Also available in black



The Renaissance in silver

New & Improved Electronic Top Control System

See page 4 for further details.



Natural Gas



Brick Chimney



Pre-Fabricated



Pre-Cast (BS EN 1858)



Electronic Top Control*

The Renaissance

Radiant - Outset Convector

Safety
Flame Supervision Device & Airwatch System

Type of heat
Radiant & Convected

Heat input - high	6.9kW
Heat input - low	2.5kW
Heat output - high	5.2kW
Heat output - low	1.0kW

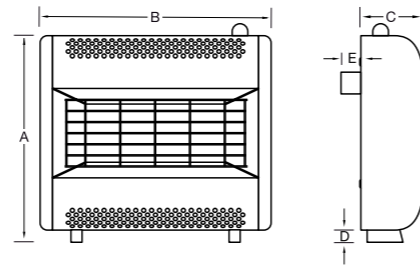

Dimensions of fire
A 652mm
B 730mm
C 200mm
D 37mm
E 60mm



The Thurcroft

Portable Stove

Safety
Flame Supervision Device & Airwatch System

Type of heat
Radiant & Convected

Heat input - high	2.6kW
Heat input - low	2.0kW
Heat output - high	2.6kW

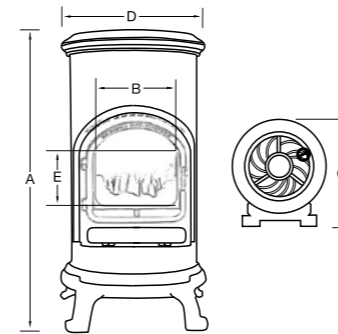

Dimensions of fire
A 712mm
B 370mm
C 445mm
D 200mm
E 145mm



high efficiency

The Thurcroft is a 100% efficient portable stove and the ideal mobile gas appliance with a living flame effect that provides the warmth, appearance and atmosphere of a traditional stove. A self contained 7kg Butane gas cylinder* housed within the body of the stove provides up to 60 hours burning time.

* Not included with the appliance.

For details on how to obtain a Butane gas cylinder please call 0870 241 1603 or visit www.calorgas.co.uk



Butane LPG*



Manual Control

Sizes and Dimensions

Every fire in this brochure has a diagram illustrating approximate dimensions, so you know whether it will fit into your home. Individual model dimensions are detailed on each product

page, whilst dimensions of those models with a Powerflue or Balanced Flue option are shown below.

The Warwick Powerflue

page 25

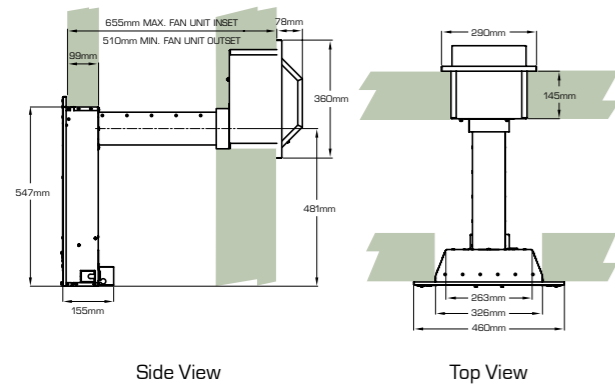

The Linear & Kenilworth Powerflue

pages 34 & 35

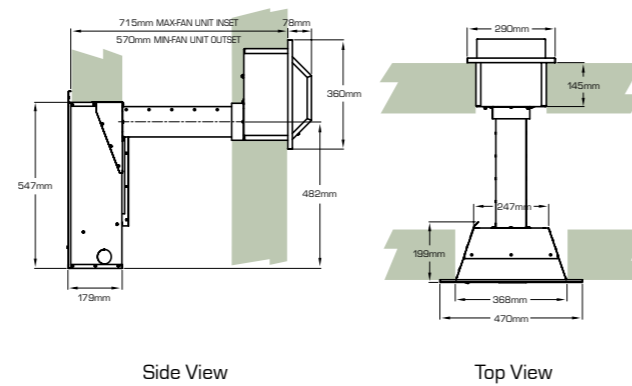

The Emberglow Balanced Flue

page 37

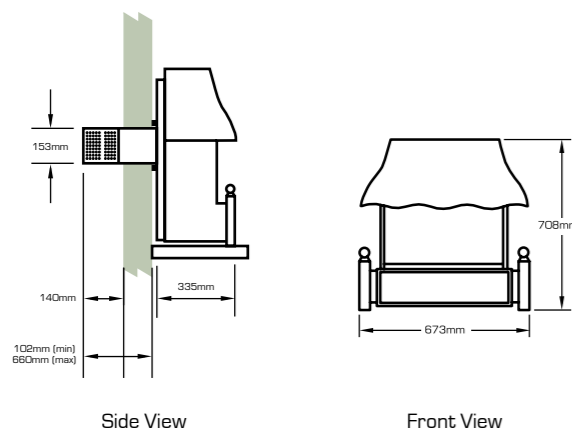

The Atlanta Balanced Flue

page 28

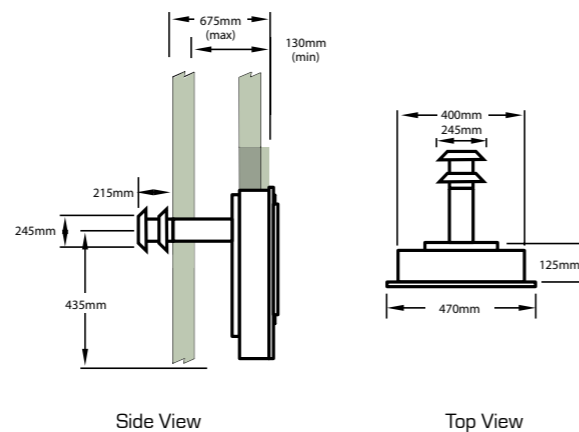

Please confirm your flue type by consulting your Flavel stockist before purchase.

Please note that the dimensions on the diagrams are intended as a guide only. For the exact dimensions, please consult the latest issue of the manufacturer's installation instructions.

N.B. If required, more detailed technical specification information is available from your Flavel stockist.

Flavel recommends that all gas appliances should be serviced annually by a Gas Safe Register engineer to ensure continued safe operation and optimum performance throughout the lifetime of the product. This is in line with good gas industry practice.

Builders' Opening sizes

	height minimum	height maximum	width minimum	width maximum
GAS FIRES				
Diamond HE	550	570	370	450
Caress HE	555	570	400	450
Kenilworth HE	550	570	370	450
Linear HE	550	570	370	450
Windsor HE	555	570	335	430
Raglan HE	555	560	410	430
Orchestra HE	555	560	410	430
Calibre	550	570	405	450
Vesta	490	500	350	400
Finesse	555	570	335	430
Curve	300	440	300	400
Rocco	540	545	750	780
Jazz	460	470	630	640
Pure	495	515	605	700
Stirling	555	570	330	430
Windsor	555	570	335	430
Caress Slimline MC	550	575	330	440
Caress Slimline SC	550	565	330	430
Warwick	555	570	335	430
Atlanta	555	560	380	425
Melody	555	570	335	430
Waverley	N/A	N/A	N/A	N/A
Richmond	555	570	405	440
Caress	550	570	400	450
Calypso	555	570	405	440
Rhapsody	555	570	405	440
Linear	555	570	375	440
Kenilworth	555	570	375	440
Renoir	525	650	305	440
Emberglow	525	650	305	440
Emberglow BF	N/A	N/A	N/A	N/A
Regent/Regent LFE	525	650	305	440
Firenza	510	650	305	440
Welcome	525	650	305	440
Strata	522	650	305	440
Misermatic	522	650	305	440
Renaissance	580	650	305	440

Please refer to installation guides for exact dimensions. BFM Europe cannot be held responsible for any building work undertaken prior to purchasing your fire. For more information you can download installation manuals for any Flavel product from our website - www.bfm-europe.com



In addition to producing fires that not only look fantastic, and are highly efficient, one of Flavel's key objectives is to make life as simple and hassle free as possible for the Installer.

Many time-saving features have been designed into the manufacturing process. As a result we are confident that once an Installer has fitted a Flavel fire they will not want to fit anything else!

1 Fixing wire kit

Flavel fires come with a fixing kit containing wire and fixing eyes that eliminate the need to drill the back panel

2 Accessible gas connection

The gas connection on Flavel insets is located front left of the control panel for easy access

3 Flange seal

Flavel's foam seal eliminates the requirement of sealing the fire box to the back panel

4 Step by step Installation instructions

Comprehensive yet easy to understand installation instructions are downloadable at www.gas-fires.co.uk

5 Pre-cut gas entry points

The firebox has a number of semi-pierced knock-outs incorporated into it to allow the installer to bring in the gas supply pipe at the most suitable point

6 Easy burner assembly removal

The burner can be removed as a complete assembly, enabling easier installation and servicing

7 Restrictor elbow included

Flavel fires come with a restrictor elbow to isolate the gas supply. These are located at the front left of the control panel for ease of access

