

# Flexiflame 140

OPEN FLUE BOILER

## GAS SAFETY (INSTALLATION AND USE) REGULATIONS

It is the law that all gas appliances are installed by a competent person  
in accordance with the above regulations

(For use on natural gas only. G20)

G.C. No 41 980 64  
FROM SERIAL N°

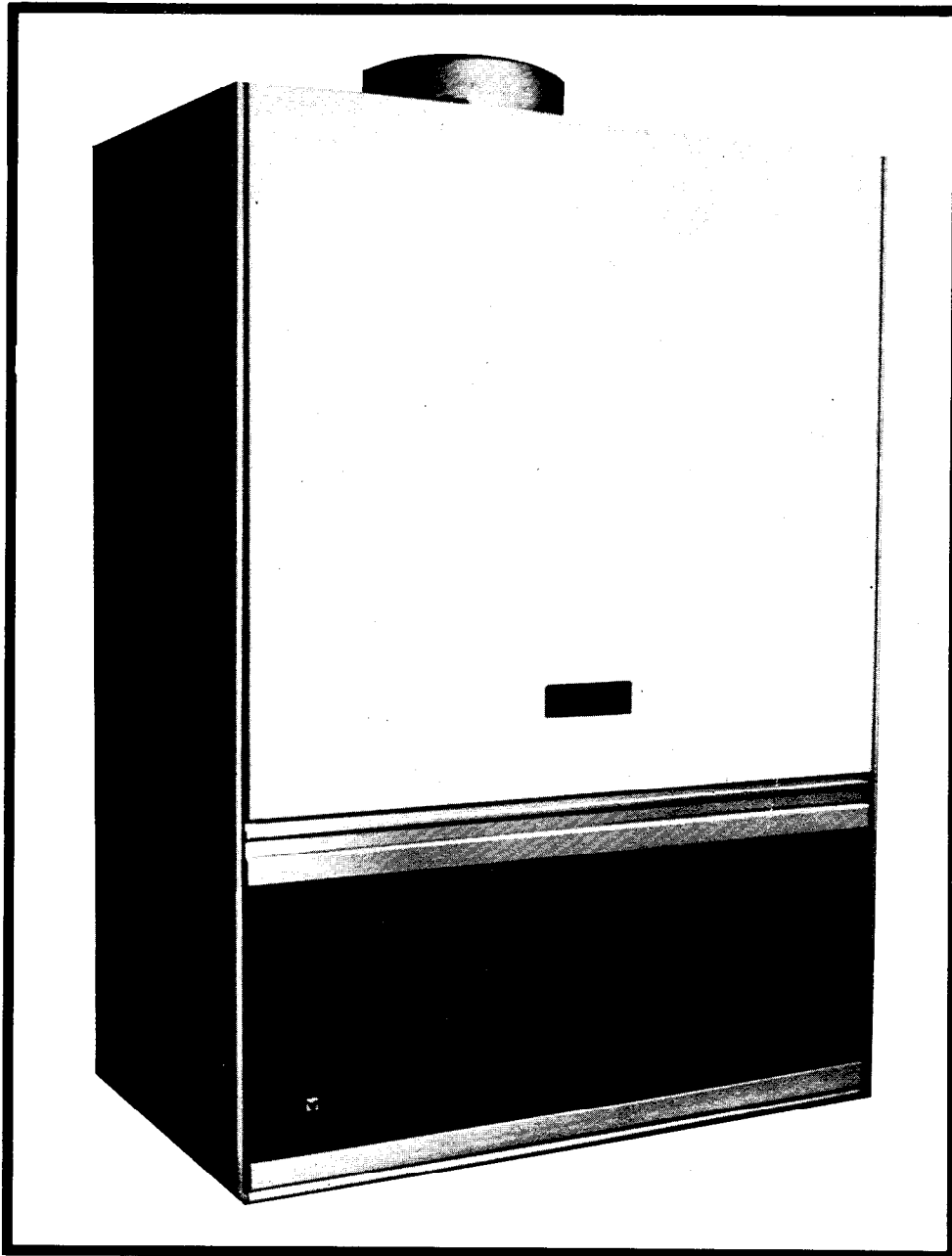

## Installation and Servicing Instructions

(Leave these instructions with the user)

**Chaffoteaux  
et Maury** 

# CONTENTS

	Page No
Health and Safety Information	1
<b>1. INTRODUCTION</b>	
1. General description, Special features, Guarantee	2
1.1 Dimensions	2
<b>2. TECHNICAL DATA</b>	
2.1 Input, Output, Burner setting pressure, Gas rate	2
2.2 Clearances	2
2.3 Flue connection	2
2.4 Gas connection	2
2.5 Water connection	2
2.6 Water flow rates and static head	2
2.7 Electrical connections	2
2.8 Weight	2
2.9 Water capacity	2
2.10 Injector sizes	2
2.11 Piezo ignitor	2
2.12 Electrode	2
2.13 Gas pressure test point	2
2.14 Boiler thermostat	2
2.15 Thermocouple and thermoelectric valve	2
<b>3. INSTALLATION REQUIREMENTS</b>	
3.1 General information	3
3.2 Location	3
3.3 Gas supply	3
3.4 Flueing	3
3.5 Air supply	3
3.5.1 Room or internal space air supply	3
3.5.2 Cupboard or compartment air supply	3
3.5.3 Effect of extractor fan	3
3.6 Water circulation systems	3
3.7 Electrical supply	3
<b>4. INSTALLATION OF BOILER</b>	
4.1 General	3
4.2 Control schemes Figs. 1, 2, 3, 4, 5, 6, 7	4
4.3 Boiler packaging	5
4.4 Mounting the boiler	5
4.5 Water connections	5
4.6 Gas connections and pipe sizes	5
4.7 Electrical connections	5
<b>5. WATER CIRCULATING SYSTEM</b>	
5.1 General	5
5.1.1 Strainers	5
5.2 Control schemes	5
5.3 Isolating valves	5
5.3.1 Electrical components Fig. 8, Fig. 9, Fig. 10	5
5.3.2 Pump positions Fig. 11, Fig. 12, Fig. 13, Fig. 14	6
5.3.3 Air separator Fig. 15	6
5.4 Circulating pump	7

5.5	Inhibitors	7
5.6	Automatic air separator	7
5.7	Open systems	7
5.7.1	Cold feeds and open vents	7
5.7.2	Hot water storage cylinder	7
5.7.3	Feed and expansion tank	7
5.8	Sealed system Fig. 15A	7
5.8.1	Safety valve	7
5.8.2	Pressure gauge	7
5.8.3	Hot water storage cylinder	7
5.8.4	Make-up system	7
5.8.5	Mains connection	7
5.8.6	Filling point	7
5.8.7	Pipework	8
<b>6.</b>	<b>COMMISSIONING AND TESTING</b>	
6.1	Electrical installation	8
6.2	Gas installation	8
6.3	Water circulation system	8
6.3.1	Open system	8
6.3.2	Sealed system Fig. 16	8
6.4	Lighting the boiler	8
6.5	Gas rate adjustment	8
6.6	Flushing	8
6.7	Fitting the casting Fig. 18, Fig. 19, Fig. 20 (Page 9)	8
6.8	Thermostat adjustment	9
6.9	To drain boiler	9
6.10	Users instructions	9
<b>7.</b>	<b>ROUTINE SERVICING</b>	
	General	9
7.1	Remove casing	9
7.2	Annual service	9
7.2.1	To clean the burner Fig. 21	9
7.2.2	To clean the heating body	9
7.2.3	To clean the pilot assembly	9
7.2.4	To remove the gas section Fig. 22 (Page 10)	9
7.2.5	To clean and grease bearing plate spindle Fig. 23	10
7.2.6	To clean thermocouple and electrode Fig. 24	10
7.3	General service	10
7.3.1	To clean burner, heating body, pilot assembly and thermocouple	10
7.3.2	To remove electrical control module	10
7.3.3	To replace diaphragm	10
7.3.4	To clean gas valve	10
<b>8.</b>	<b>REPLACING COMPONENTS</b>	
8.1	To replace thermoelectric valve	10
8.2	To replace overheat thermostat	10
8.3	To replace piezo unit	10
8.4	To replace pump	10
8.5	To replace pump and volute	10
8.6	To replace heat exchanger	11
8.7	To replace boiler thermostat	11
<b>9.</b>	<b>FAULT FINDING</b>	12
<b>10.</b>	<b>SHORT SPARE PART LIST</b>	13

# CONTROL OF SUBSTANCES HARMFUL TO HEALTH

## Important

To comply with the Control of Substances Harmful to Health Regulation 1988 we are required to provide information on the following substance that is contained in this appliance.

## Description

Combustion Chamber Lining.

## Material

Alumino Silicone Fibre.

## Precautions

During servicing, keep the dust generation to a minimum and avoid inhaling any dust and contact with the skin and eyes. Normal handling and use will not present any discomfort, although some people with a history of skin complaints may be susceptible to irritation.

When disposing of the lining ensure that it is securely wrapped and wash hands after contact.

# 1 Introduction

The FLEXIFLAME 140 is a wall mounted, low water content open flued boiler. The boiler is rated between 20.5 kW (70,000 Btu/h) and 41 kW (140,000 Btu/h) outputs.

The boiler is designed for use with Natural Gas only.

The FLEXIFLAME 140 is intended for the larger domestic installations, swimming pools and for commercial or industrial applications. The boiler is suitable for open vented or sealed water systems.

**A pump must be installed in the water circulation system** irrespective of whether the system is of the open or sealed type. The pump incorporated in the boiler is sufficient only to overcome the resistance of the boiler, the boiler has a fully

adjustable electric thermostat which operates the boiler pump.

The FLEXIFLAME 140 is supplied in one carton, it is essential that the monotube is fitted (the monotube is the 54 mm horizontal tube at the base of the appliance).

## Guarantee

The manufactures guarantee on this appliance is for 12 months from this date of purchase. The guarantee is void if the appliance is not installed in accordance with the recommendations made herein.

## 1.1 Dimensions

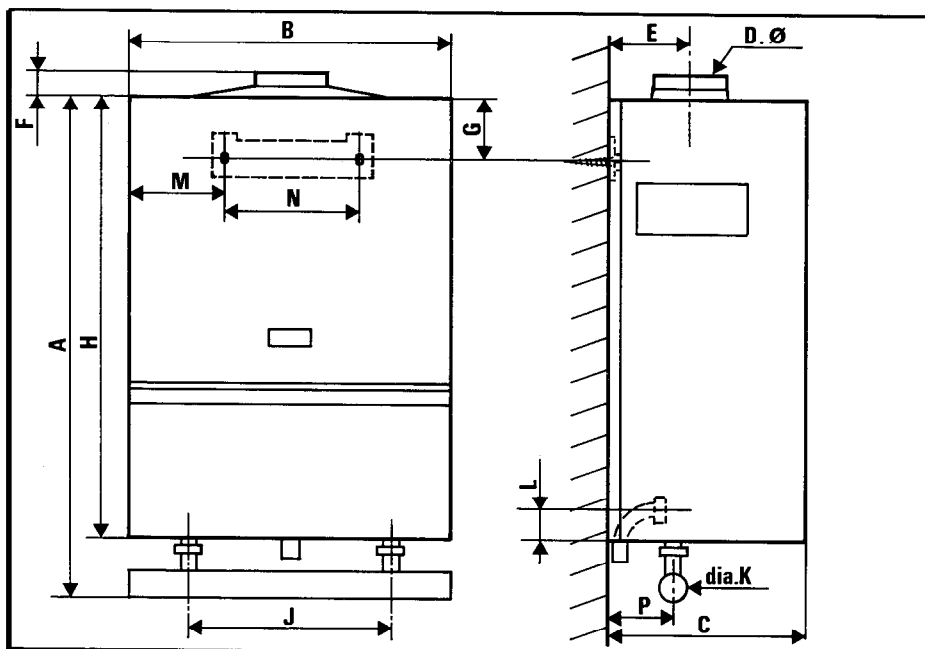

	mm	(ins)
A	925	(36.4)
B	600	(24.0)
C	365	(14.3)
D	174	(6.9)
E	150	(6.0)
F	65	(2.5)
G	95	(3.75)
H	820	(32.25)
J	390	(15.3)
K	54	(2.0)
L	45	(2.0)
M	165	(6.5)
N	260	(10.6)
P	95	(3.75)

## 2. Technical data

2.1 Heat Output		Heat Input		Burner setting Pressure		Gas Rate	
kW	(Btu/h)	kW	(Btu/h)	mbar	(ins. w.g.)	m <sup>3</sup> /h	(ft <sup>3</sup> /h)
20.5	(70 000)	27.0	(91 100)	3.4	(1.4)	2.5	(89,43)
41.00	(140 000)	51.9	(177 200)	12.8	(5.1)	4.65	(164,25)

### 2.2 Clearance for installation and servicing

Side .....	150 mm (6 ins)
Top .....	100 mm (4 ins)
Bottom .....	150 mm (6 ins)
Front .....	1000 mm (3ft. 3 ins)

### 2.3 Flue connection

A nominal 150 mm (6 ins) lightweight flue is required. The draught diverter is integral. It is not necessary to fit a split collar.

### 2.4 Gas connection..... R 3/4 ..... (3/4" BSP male)

### 2.5 Water connection

Flow .....	54 mm copper (socket)
Return .....	54 mm copper (socket)

### 2.6 Water flow rates

Minimum flow rate .....	2209 l/h (8.1 g.p.m.)
Maximum flow rate .....	3183 l/h (11.66 g.p.m.)
Minimum static head .....	3 m (10 ft)
Maximum static head .....	30 m (100 ft)

### 2.7 Electrical connections

240 V single phase 50 hz supply fused 1 amp

### 2.8 Weight .....

52 kg (114 lb)

### 2.9 Water capacity .....

1 litre (0.22 gals)

### 2.10 Injector .....

Burner 1.18 mm (.046 in)

Pilot 0.30 mm (.011 in)

### 2.11 Piezo ignitor .....

Vernitron 60065

### 2.12 Electrode .....

Spark Gap 5 mm (.196 in)

### 2.13 Pressure test points

Gas inlet and left hand burner manifold

### 2.14 Boiler thermostat .....

Sopac AE 350 A

### 2.15 Thermocouple and thermoelectric valve (Chaffoteaux et Maury)

The 24 blade stainless steel Chaffoteaux burner is fitted with 1.18 mm injectors. The non-adjustable permanent pilot is manually ignited by a piezo igniter. The boiler is controlled by an adjustable thermostat which is fitted into the return side of the monotube. The flow temperature measured on the flow side of the monotube will vary relative to the mass flow rate through the monotube but within the range 82° C ± 4° C (180°F ± 7° F) with a temperature differential between 11°C min and 20°C max.

### 3. Installation requirements

#### 3.1 General

The installation of the boiler must be in accordance with the Gas Safety installation and use Regulations, relevant Building Regulations, the Byelaws of the Local Water Undertaking, the Safety Document 635, the Electricity at work Regulations BS 7671. It should also be in accordance with the following British Standard Codes of Practice - BS 6891, BS 7953, BS 7074 : 1 : 2, BS 5449 : 1, BS 5440 : 1 : 2.

#### 3.2 Location

The position chosen for the boiler must permit the provision of a satisfactory flue termination and also provide adequate space for servicing and air circulation around the boiler.

The boiler must not be installed in a room or internal space containing a bath or a shower. In a bedroom area, a bed-sitting room, or a private garage.

Where installation will be in an unusual position, special procedures may be necessary, and BS 6798, gives detailed guidance on this aspect.

A cupboard or compartment used to enclose the boiler must be designed and constructed specifically for this purpose. An existing cupboard or compartment may be used provided that it is modified for the purpose.

Details of essential features of cupboard/compartment design, including airing cupboard installations are given in BS 6798.

#### 3.3 Gas supply

The gas installation should be in accordance with BS 6891.

The meter to be used must be of adequate capacity to meet the total gas load, i.e. boiler plus other gas appliances.

Ensure that the pipework from the meter to the boiler is of adequate size. Do not use pipes of a smaller size than the boiler gas connection.

The complete installation must be tested for soundness as described in the above standard.

#### 3.4 Flueing

Detailed recommendations for flueing are given in BS 5440 : Part 1.

The following notes are for general guidance only : -

**3.4.1** The boiler should be sited such that the maximum possible length of the flue system can be contained within the building and that the route of the flue rises continuously to the terminal and is as direct as practicable.

The first 600 mm (2 ft) of flue pipe should rise vertically from the draught diverter connection before the use of any bends or elbows.

Horizontal or shallow angle runs, right angled bends and mitred elbows should be avoided.

Where an existing brick chimney is to be used it should be swept thoroughly before connection of the new boiler, and the chimney should be lined. The boiler can be used with fanned or fan diluted flues.

An approved British Gas terminal must be fitted and the terminal sited at not less than 600 mm (2 ft) above the roof edge, and, where possible, above the ridge line. The flue must not be terminated at or adjacent to a wall face (except for fan diluted flues).

#### 3.5 Air supply

Detailed recommendations for air supply are given in BS 5440 : 2.

The following notes are intended to give general guidance.

##### 3.5.1 Room or internal space air supply

Where the boiler is to be installed in a room or internal space, the boiler requires the room or internal space containing

it to have a permanent air vent. This vent must be either direct to outside air or to an adjacent room or internal space which must itself have a permanent air vent of at least the same size direct to outside air.

The minimum effective area of the permanent air vent(s) related to the maximum rated input of the boiler and should be 202 cm<sup>2</sup> (30.5 in<sup>2</sup>).

##### 3.5.2 Cupboard or compartment air supply

Where the boiler is to be installed in a cupboard or compartment permanent air vents are required (for combustion, flue dilution and cooling purposes) in the cupboard or compartment at high and low level. These air vents must either communicate with a room or internal space or be direct to outside air.

The minimum effective areas of the permanent air vents required in the cupboard or compartment are specified below and are related to the maximum rated heat input of the boiler.

POSITION OF AIR VENTS	AIR VENT AREAS	
	Air from room or internal space	Air direct from outside
High Level	468 cm <sup>2</sup> (72.5 in <sup>2</sup> )	234 cm <sup>2</sup> (36 in <sup>2</sup> )
Low Level	936 cm <sup>2</sup> (145 in <sup>2</sup> )	468 cm <sup>2</sup> (72.5 in <sup>2</sup> )

**Note :** Both air vents must communicate with the same room or internal space or must both be on the same wall to outside air.

Where cupboard or compartment air vents communicate with a room or internal space, the room or internal space must itself have a permanent air vent(s) as specified above (3.5.1).

##### 3.5.3 Effect of an extract fan

If there is any type of extract fan fitted in the premises, there is a possibility that if adequate air inlet area from outside is not provided, spillage of the products from the boiler flue could occur, when the extract fan is in operation. Where such installations occur, a spillage test as detailed in BS 5440 : 1 : must be carried out and ventilation requirement to BS 5440 : 2.

#### 3.6 Water circulation systems

Open or sealed type central heating systems should be in accordance with the relevant recommendations given in BS 5376 : 2, BS 5449 : 1 (for small bore or microbore systems).

Hot water systems should be in accordance with the relevant recommendations given in BS 5449 and BS 5546.

#### 3.7 Electrical supply

**This appliance must be earthed.** All wiring must conform to the BS 7671. The Flexiflame 140 requires a 240 V, single phase, 50 Hz supply. The boiler should be connected to the mains via a fused double pole switch or via a 13 amp. socket outlet in conjunction with a fused plug. The fuse rating should be 3 amp.

The point of connection to the mains should be readily accessible and adjacent to the boiler.

The supply chord must be 0.75 mm<sup>2</sup> three core heat resisting cable.

### 4. Installation of boiler

#### 4.1 General

The wall on which the boiler is sited must be capable of adequately supporting the weight of the boiler and any ancillary equipment and should be non-combustible.

A vertical flat area is required for the boiler as follows :

Wide	900 mm	36 ins
High	1185 mm	47 ins.

Above dimensions include the necessary clearances around the boiler for case removal and for air movement.

## 4.2 Control schemes

Most normal pumped primary control schemes can be used, including non-electrical heating and hot water controls.

Hot Water Only, Pump, Time Clock and Cylinder, Thermostat

Fig. 1

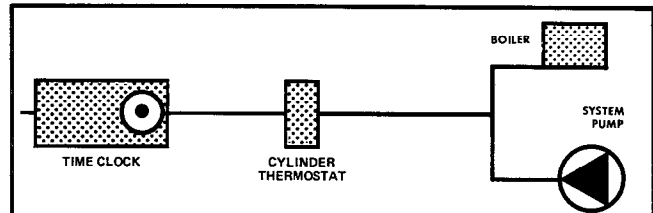

Heating Only, Pump, Time clock and Room Thermostat

Fig. 2

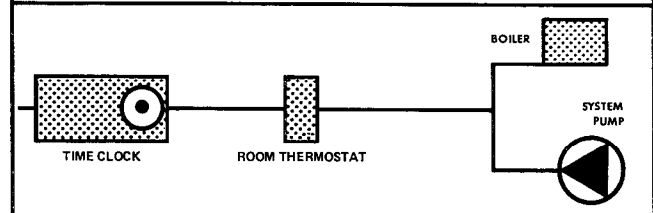

Hot Water and Heating, Pump, Programmer, Room/Cylinder Thermostat and Flow Share Valve.

Fig. 3

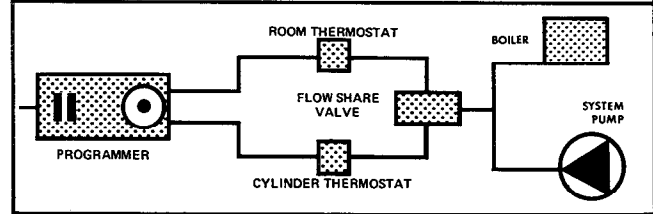

Hot Water and Heating, Pump, Programmer, Room/Cylinders and two motorised valves.

Fig. 4

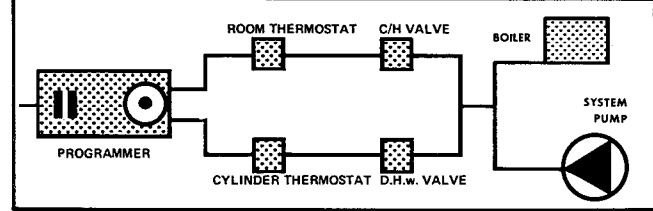

The following diagrams show typical control schemes using electrical controls only.

The following diagrams show typical control schemes using electrical/non-electrical controls.

Hot Water and Heating, Pump, Time Clock and Non-Electrical Hot Water and Heating Controls.

Fig. 5

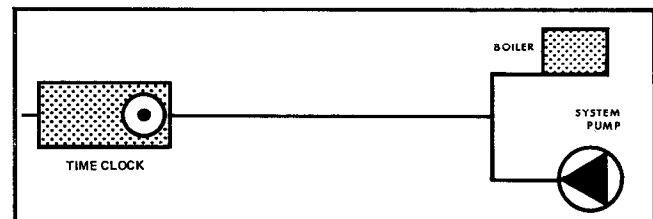

Hot Water and Heating, Pump, Time Clock, Non-Electrical Hot Water Control and Electrical Heating Control.

Fig. 6

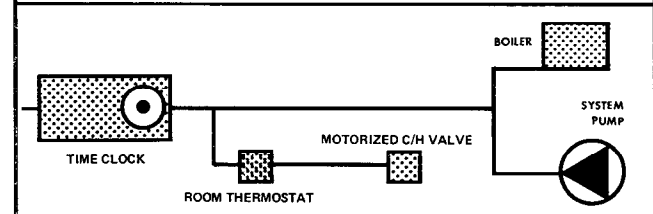

Hot Water and Heating, Pump, Time Clock, Non-Electrical Heating Control and Electrical Hot Water Control.

Fig. 7

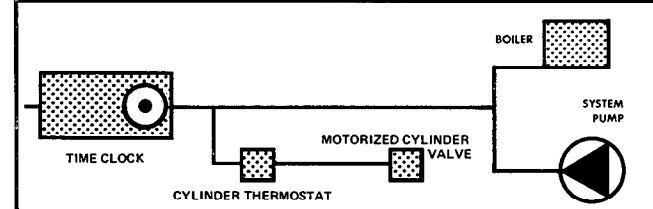

It is not normally possible to use full programming facilities when using a mixture of electrical and non-electrical controls, but some non-electrical hot water controls are now available with an external micro-switch which would allow the scheme as in fig. 6 to be fully programmed.

Where a mechanical type cylinder thermostat is considered the three port type with by pass must be used.

Where thermostatic radiator valves are used a system by pass will be necessary to maintain a flow rate in the monotube of not less than 8.1 g.p. m. required to prevent recirculation in the monotube due to the action of the boiler pump.

### 4.3 Boiler packaging

- Each boiler is delivered in a protective carton.
- Remove packing pieces before lifting out boiler.
- Remove boiler from carton. **DO NOT stand or support the boiler on the draught diverter or the bottom chassis carrying the isolating valves.**

### 4.4 Mounting the boiler

- Using dimensions shown on Page 2 fit the wall mounting plate to the wall using the screws provided.
- Hang boiler on the plate.
- Fit monotube to flow and return connections on boiler with thermostat phial to the left of the boiler.
- Remove thermostat phial from rear of electrical control module and insert phial in pocket, to the left of the monotube and secure with retaining pin.

### 4.5 Water connections

- Flow and return connections are made to the monotube at the base of the boiler. The return connection is on the left –the flow on the right (54 mm copper tube) viewed from front.

### 4.6 Gas connections

- The gas service tap is fitted to the appliance.
- Fit gas inlet bend and filter-washer to inlet of gas service tap.
- Gas connection is R 3/4 (3/4 in. BSP male) thread.
- The gas supply pipe should not be less than 22 mm and should be connected direct on to meter. The pipe run should not exceed 9 meters. If the gas run is greater than 9 meters (29.5 ft) in length consult the following table.

GAS PIPE SIZES IN MM										
Equivalent length of pipe including fittings										
Metres ...	3	6	9	12	15	20	25	30	40	50
Diameter .	22	22	22	28	28	28	28	28	35	35

- The gas supply pipe size should be sufficient to ensure that there is 20 mbar (8 in.w.g.) pressure at the gas service tap when the boiler is working.

### 4.7 Electrical connections (figs. 8, 9 and 10)

- Withdraw fuses.
- Remove two screws on left hand side of electrical control module cover and open left hand section.
- Enter 0.75 mm<sup>2</sup> flexible heat resisting cable from rear of module. Pass under clamp and secure to their respective terminal connections.

**Note:** The length of the earth wire between the cord anchorage and the terminal must be such that the live and neutral wires become taut before the earth wire if the supply cord is pulled.

- For connection see wiring diagram.
- Tighten cable clamp.
- Secure door with two screws and replace fuses.
- Switch ON/OFF switch to OFF position.

## 5. Water circulating system

### 5.1 General

The Flexiflame 140 is a low water content boiler designed **only** for use with fully pumped systems. It may be used with open (vented) or sealed systems, all safety controls other than the safety valve, being incorporated in the boiler. The thermostat is adjustable and on its maximum setting gives a nominal 82° C (180° F) flow ± 4° C (7° F) depending on flow through monotube.

Thermostatic control should be fitted to the cylinder and heating circuits.

**Under normal circumstances the boiler should not be operated other than with the monotube supplied.**

### 5.1.1 Strainers

Where the Flexiflame 140 is used as a replacement for a boiler on an existing system, the system should be flushed and cleaned using a suitable chemical cleaner following the manufacturer's recommendations and fitted with a strainer in the return before the boiler.

### 5.2 Control schemes

The boiler is electrically controlled. The firing of the boiler is initiated by the pump incorporated in the boiler. This pump is for the boiler only and is not intended to act as a system pump which must be supplied, correctly sized for the system design, by the installer.

Most normal pumped primary control schemes can be used including thermostatic radiator and cylinder valves. When using motorised valves the controls should be so arranged to switch off the boiler when circuits are satisfied.

For details of control schemes see 4.2. Chaffoteaux can be consulted where technical assistance is required.

### 5.3 Isolating valves

Two isolating valves are fitted to the boiler to allow for complete isolation of the boiler for servicing.

### 5.3.1 Electrical components

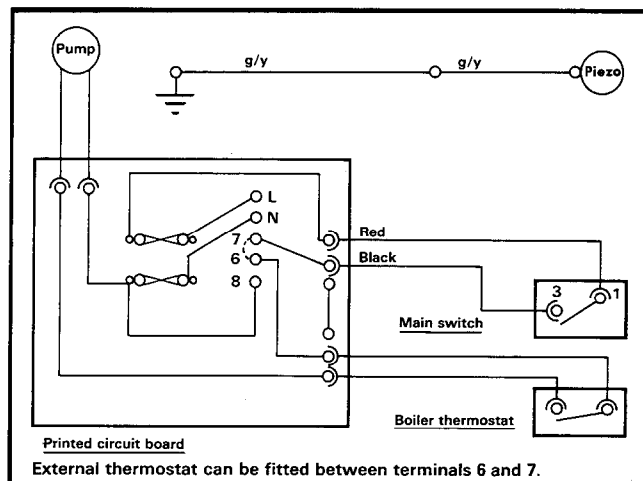

Fig. 8

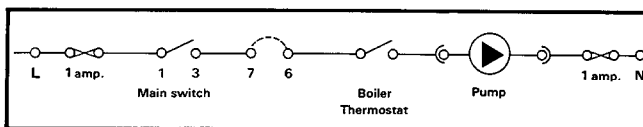

Fig. 9

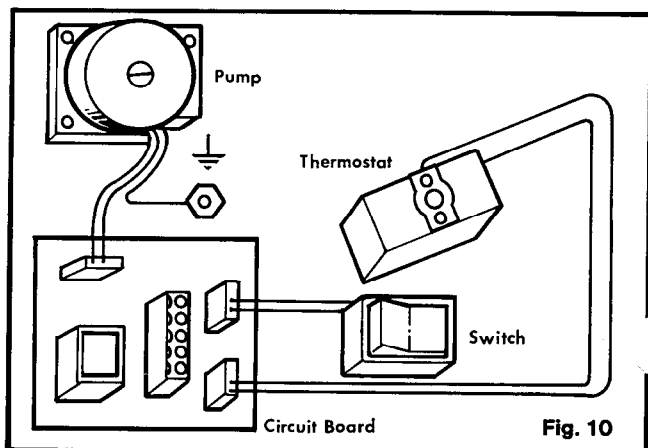
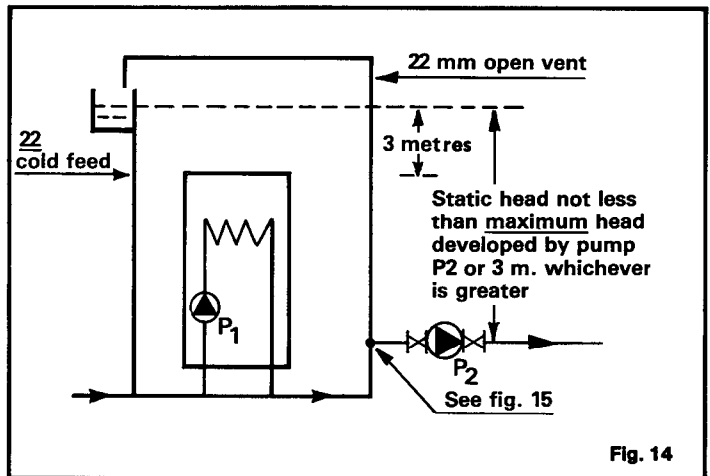
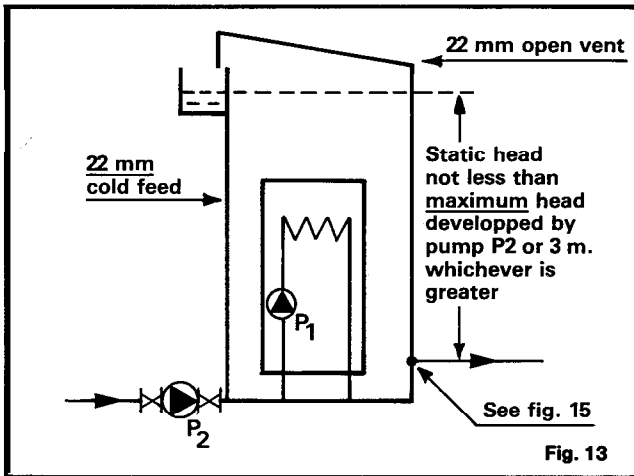
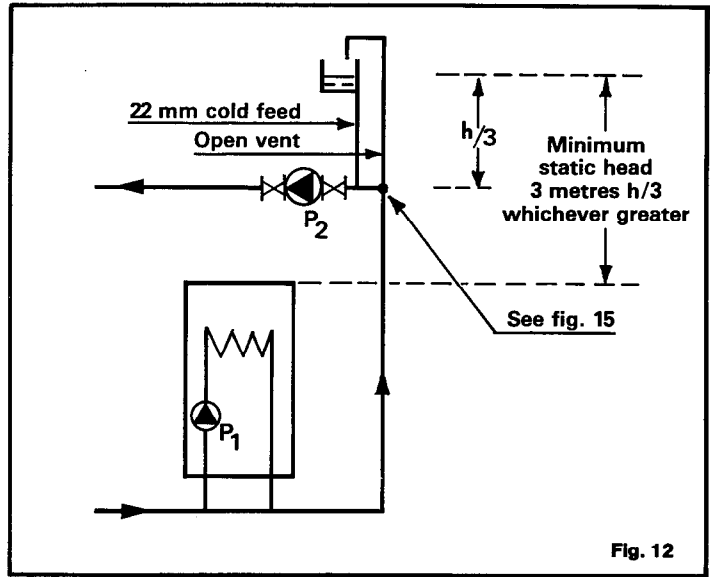
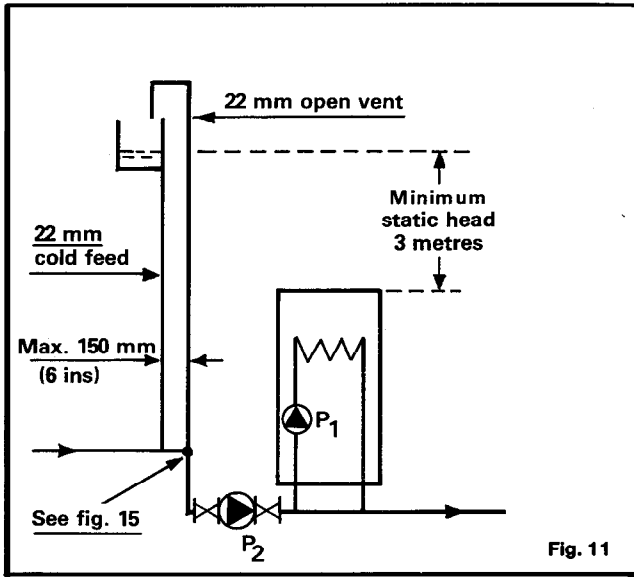

Fig. 10



### 5.3.2 Pump positions



N.B. h = maximum head developed by pump P<sub>2</sub>

### 5.3.3 Air separator

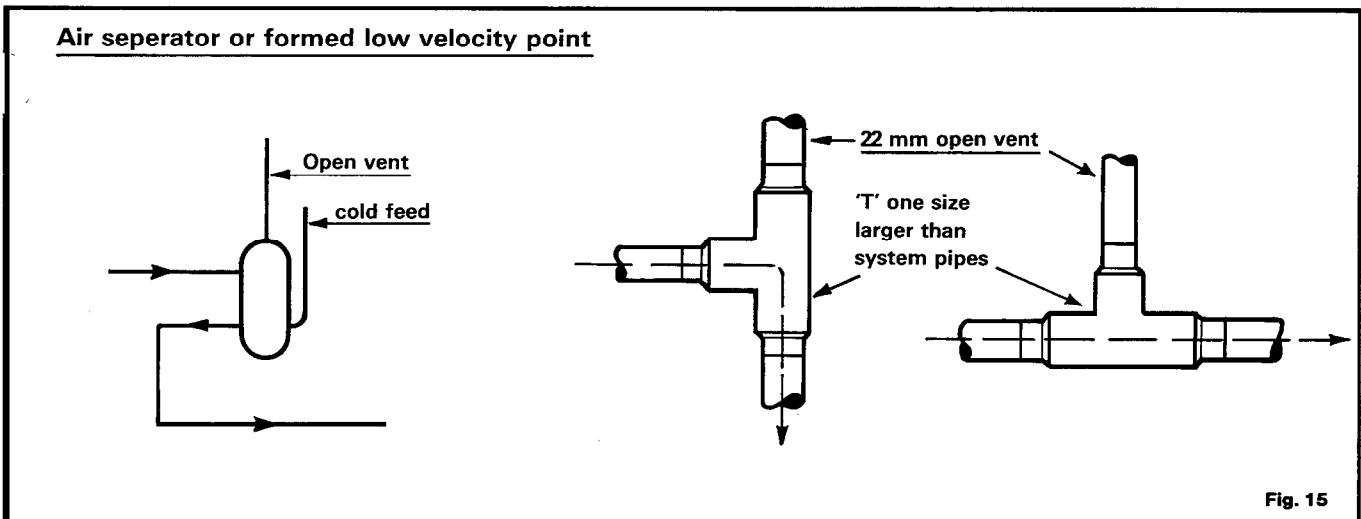

## 5.4 Circulation pump

The system circulating pump should be sized relative to the resistance of the connected load and the system design  $\Delta t$  selected. The mass flow rate through the manifold should not be less than 8.1 g.p.m. (2209 litres/hour) and the temperature difference across the manifold should not be greater than 18 °C. The boiler requires a minimum static head of 3 m. (10 ft) irrespective of whether the pump is fitted on the flow or the return.

Most pump manufacturers require a minimum static head on the pump inlet to prevent cavitation. The boilers are designed for a system temperature drop of 18° C on full load but the monotube arrangement provides a built in by pass feature for temperature differences of less than 18° C.

## 5.5 Inhibitors

Chaffoteaux Limited, generally, recommend the inclusion of an inhibitor with heating and hot water systems utilising FLEXIFLAME boilers.

The following are the appliance manufacturer recommendations.

- 1) Use only a British Gas or similar approved inhibitor from the Fernox range manufactured by Industrial (Anti Corrosion) Services, Britannia House, Waltham Cross, Herts. Telephone : 0799-085811 or Grace Dearbon Limited, Widnes, Cheshire WA8 8UD - Telephone : 051-424-5351.
- 2) Use only the quantities specified by the inhibitor manufacturer.
- 3) Cleanse the system, as may be required by the inhibitor manufacturer.
- 4) Add inhibitor only after flushing when finally refilling system.

## 5.6 Automatic air separator

Chaffoteaux Limited strongly recommend the inclusion of a British Gas accepted automatic air separator in the system as shown in fig. 15

The open vent pipe should rise continuously from the system pipework.

It should not be entered horizontally into the system pipework. The use of an enlarged T to create a low velocity point is recommended. The preferred arrangement is shown in fig. 15

## 5.7 Open systems only

### 5.7.1 Cold feeds and open vents

The cold feed and open vent should be so positioned that pumping over and sub-atmospheric pressures are avoided.

Chaffoteaux recommend that a 22 mm cold feed is fitted on the left and a 22 mm open vent on the right of the

boiler. The connection should be so arranged that there is a low velocity point at the open vent junction with the system.

### 5.7.2 Hot water storage cylinder

The domestic hot water cylinder used with a Flexiflame 140 must be of the indirect coil and high recovery type BS 1566 Pt. 1. Single feed cylinders are not suitable for use with this appliance. Flow and return pipework to the cylinder should be in 22 mm pipe.

### 5.7.3 Feed and expansion tank

The feed and expansion tank should be adequately sized to accept the system water expansion, it should not be mounted closer than 9 in. to a ceiling to allow access to the ball valve.

## 5.8 Sealed system only

### 5.8.1 Safety valve

A safety valve shall be fitted close to the appliance on the flow pipe by a horizontal or a vertically upward connection. Only safety valves set to operate at 3 bar (45 lb/in<sup>2</sup>) shall be used; they shall be so positioned, or any discharge pipe so arranged, that discharge of water or steam from the valve cannot create a hazard to occupants of the premises or cause damage to electrical components and wiring.

### 5.8.2 Pressure gauge

A pressure gauge covering at least the range 0-4 bar (0-60 lb/in<sup>2</sup>) shall be fitted to the system adjacent to, and visible from, the filling point. A temperature gauge should be fitted.

### 5.8.3 Hot water storage cylinder

The hot water cylinder shall be the indirect coil type which is suitable for the system pressure.

### 5.8.4 Make-up system

Provision shall be made for replacing water lost from the system either:

- (i) From a make-up vessel or tank mounted in a position higher than the top point of the system, and connected through a non-return valve to the system on the return side of the hot water cylinder or the return side of all heat emitters, or,
- (ii) Where access to a make-up vessel would be difficult, by prepressurisation of the system (see also 5.8.6 Filling point).

### 5.8.5 Mains connection

There shall be no connection to the mains water supply or to the water storage tank supplying domestic water, even through a non-return valve without the approval of the local water authority.

### 5.8.6 Filling point

The system should be fitted with a filling point at low level. Methods of filling and marking up sealed systems described in BS 5376 : 2

## Diagrams showing sealed system layout

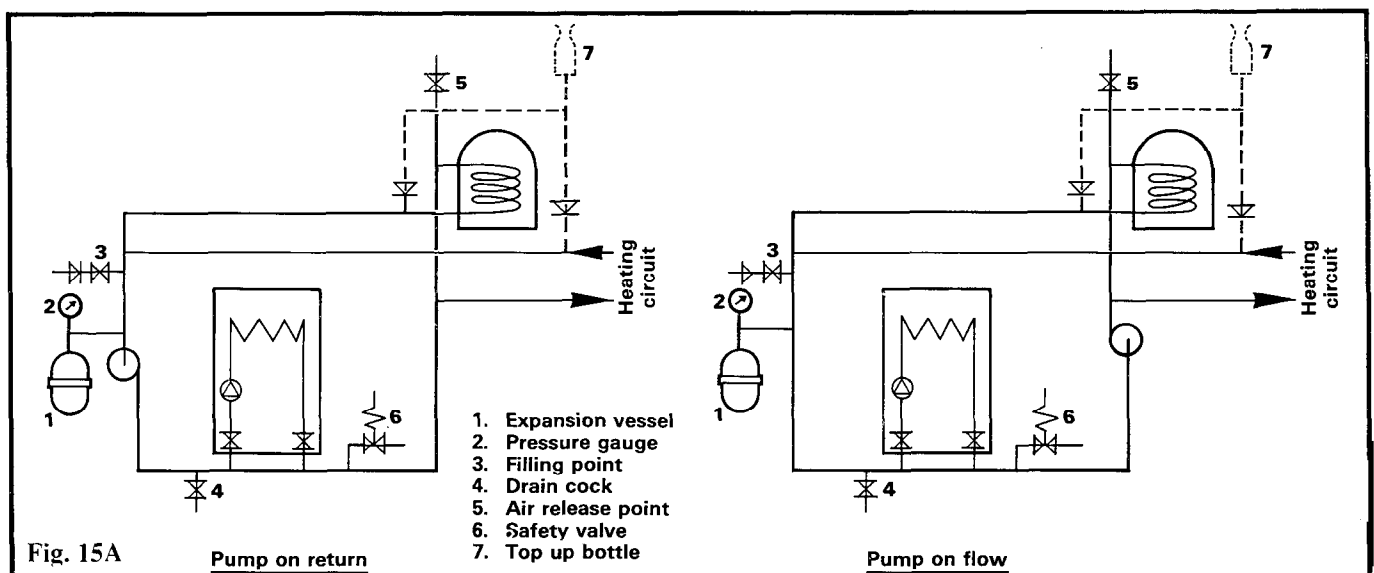

### 5.8.7 Pipework

Pipework should be of copper ; small bore or microbore with capillary or compression jointing to a high standard. Leak sealant shall not be used in the system.

## 6. Commissioning and testing

### 6.1 Electrical installation

Checks to ensure electrical safety should be carried out by a competent person i.e. earth continuity, polarity and resistance to earth. In the event of an electrical fault after installation of the appliance preliminary electrical system checks shall be carried out.

### 6.2 Gas installation

The whole of the gas installation, including the meter, should be inspected and tested for soundness and purged in accordance with the recommendations of BS 6891

### 6.3 Water circulation system

#### 6.3.1 Open system only

The whole of the system should be thoroughly flushed out with cold water without the system circulating pump in position. Ensure that all valves are open.

With the pump fitted, the system should be filled and air locks cleared. The boiler water section can be vented if necessary by unscrewing the drain valve (see A fig. 16). Vent all radiators and check for water soundness.

Light the boiler as detailed in 6.4

#### 6.3.2 Sealed system only

The whole of the system should be filled and thoroughly flushed out with cold water without the circulating pump in position. Ensure that all valves are open. (The system must be filled with water either from a sealed system filler pump with a break tank, or by any other method approved by the local Water Undertaking).

With the circulating pump fitted, the system should be filled and air locks cleared until the pressure gauge registers 1.5 bar (21.5 p.s.i.). (The boiler water section can be vented if necessary by unscrewing the drain valve, see A fig. 16). Vent all radiators and check for water soundness.

Manually raise the water pressure to ensure that the safety valve lifts. This should occur at  $\pm 0.5$  bar ( $\pm 7.2$  p.s.i.) on the max working pressure i.e. 3 bar (43.5 p.s.i. should operate at 3.5 bar (50.75 p.s.i.).

Release water from the system until the initial system design Pressure is attained, taking into account any difference in height between the pressure gauge and the point at which the pressure vessel is connected.

Light the boiler as detailed in 6.4 and thoroughly full the system again after the design temperature has been achieved.

### 6.4 Lighting the boiler

The following procedure should be followed :

a) Check that fuses have been replaced (see 4.7).

b) Open gas service tap by turning to  $\uparrow$  (see B fig. 16).

c) Press in pilot valve knob and light pilot using the ignition button, continue to hold in the pilot valve knob for 30 seconds and release (n.b. the pilot should remain alight, it may be necessary to wait a few moments for gas to reach the pilot) (see C fig. 16).

d) If the pilot extinguishes for any reason wait 3 minutes before relighting.

e) The boiler is now ready to operate and will light when switched on at ON/OFF switch and thermostat is turned to + which starts the pump (D and E fig. 19).

f) Test for gas soundness.

g) Check, and if necessary, adjust the gas rate as detailed in 6.5 ten minutes after lighting from cold.

### 6.5 Gas rate adjustment

Switch off the boiler at the electrical control box. Set the system circulation pump in operation and open all system control valves.

Remove the pressure test point screw from the left hand end of the burner manifold and connect pressure gauge suitable for measurement in the range 0-20 mbar (0-8 in.w.g). Remove the hexagonal cap from the front of the gas volume governor to expose the adjusting screw (D fig. 16).

Turn on the boiler at the electrical control box and, after running the boiler for ten minutes from cold adjust the burner pressure to that shown in graph (fig. 17). The pressure will be reduced for clockwise movement of the screw, increased for anti-clockwise movement.

Turn off the boiler at the electrical control box, remove the gauge and re-fit the pressure test point screw and gas volume governor cap. Test for gas soundness.

Mark the data badge against output to which the boiler has been adjusted.

The data badge is situated at the bottom right hand side of the chassis (fig. 16).

### 6.6 Flushing

The water system should then be heated to maximum working temperature and examined for water soundness. Gas electricity and water should then be turned off and the water system rapidly drained whilst still hot.

The system should again be filled and cleared of air locks sealed systems should be adjusted to the initial system design pressure, any set pointer on the pressure gauge should be set to coincide with the indicating pointer. Re-adjust controls to appropriate setting. Examine for water soundness.

Add inhibitor to the system if required in the specification (see 5.5).

### 6.7 To fit casing

- Fit side panels by hooking over pegs at top and securing with screw bottom rear.

- Fit control module cover, secure with five screws two each side and one in centre (F fig. 19).

- Fit front panel by hooking on pegs at top of boiler and secure with three screws G along bottom (fig. 19).

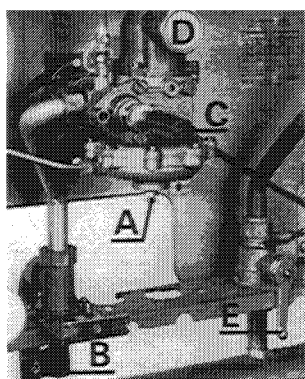

Fig. 16

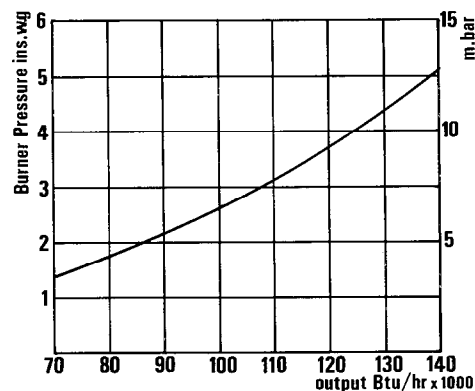

Fig. 17

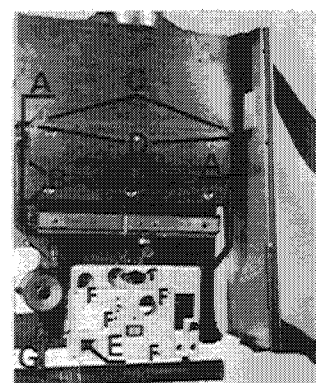

Fig. 18

- Fit control knob.
- Remove glass panel from carton.
- The hinges are held in position by a metal strap (fig. 19).
- Remove the screws securing the strap and set aside for re-use both the strap and the screws.
- Slide the left hand side hinge from glass panel and slot into left hand side vertical trim.
- Locate glass panel on to left hand side hinge with the panel in a vertical position.
- Locate right hand side hinge into the right hand side vertical trim.
- Using the screws removed re-fit the transit strap beneath the glass panel.
- Finally secure hinges with screw from front of each hinge.

### 6.8 Adjust thermostat to system design requirements.

Set the boiler in operation and balance the system adjusting thermostats, time clocks and other controls.

### 6.9 To drain boiler

Close the isolating valves on the boiler by turning in a clockwise direction. Drain the boiler by unscrewing the drain valve (A fig. 16).

### 6.10 Users instructions

Hand the user's instructions to the user for retention and instruct in the safe operation of the boiler.

Advise the user of the precautions necessary to prevent damage to the system and to the building in the event of the system remaining inoperative during frost conditions.

Finally advise the user that, for continued efficient and safe operation of the boiler, it is important that adequate servicing is carried out at regular intervals recommended by the local gas region, your local Chaffoteaux et Maury Service Centre or other C.O.R.G.I. registered personnel in accordance with the gas safety (installation and use) regulations.

## 7. Routine Servicing

To ensure continued efficient and safe operation of the appliance it is recommended that it is checked and serviced as necessary at regular intervals. The frequency of servicing will depend upon the particular installation condition and usage, but in general once a year should be adequate.

It is the law that any service work must be carried out by a competent person, such as British Gas, other C.O.R.G.I. registered personnel or your local Chaffoteaux Service Centre, in accordance with the Gas Safety (Installation and Use) Regulations. This routine service will normally be certified to :

- 1) Cleaning the burner.
- 2) Cleaning the heat exchanger.
- 3) Cleaning the gas control.
- 4) Cleaning and greasing bearing pilot spindle.
- 5) Cleaning the diaphragm.

The following schedules are recommended.

- a) Check the function of the appliance, burner pressure, gas flow rate and soundness.
- b) Observe flame picture and undertake combustion test.
- c) Check, clean or replace components as necessary.

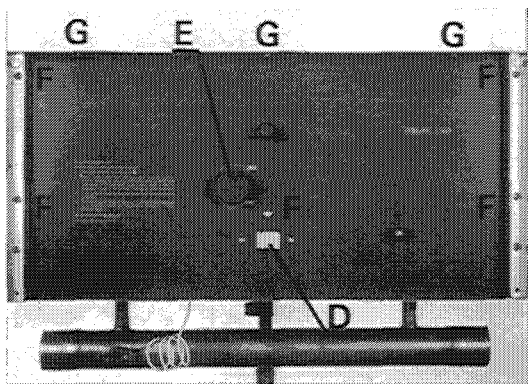

Fig. 19

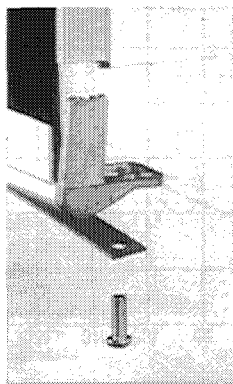

Fig. 20

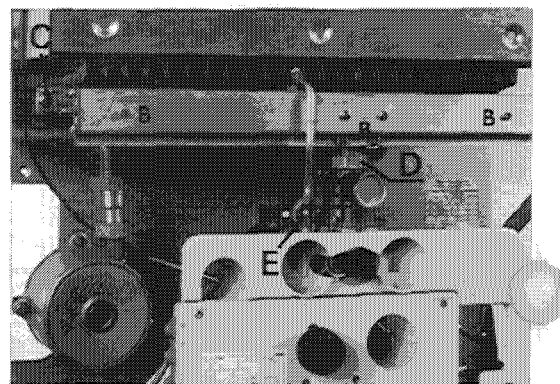

Fig. 21

**N.B. :** Before commencing any work turn off gas at the gas inlet tap, and ensure that the electricity supply is disconnected. Inhale the flow and return, and train appliance if required.

### 7.1 Remove casing

- Remove thermostat knob by pulling off.
- Remove two screws at bottom rear of side panels.
- Remove screw from centre of controls panel.
- Ease whole case forward and guide over piezo and pilot operating plunger.
- Lift off turret fixings at top of appliance.

### 7.2 Annual service

#### 7.2.1 To clean the burner (fig. 21)

- Unscrew the pilot tube clamping screw A.
- Remove the pilot tube by lifting out of bracket.
- Remove six screws B which retain the burner manifold (screws are different lengths).
- Remove manifold gasket and pilot support bracket and disconnect thermocouple at thermoelectric valve, pull off connection on high limit thermostat, disconnect piezo ignitor.
- Remove two screws C at ends of rear of burner.
- Unscrew nut D which secures manifold bend to gas section
- Remove burner by moving to the left **taking care to retain gasket.**
- Invert the burner head and clean by brushing.
- Replace in reverse order, ensuring that the gasket between the burner manifold and the gas section is in place.

#### 7.2.2 To clean heating body. Remove case as described in 7.1 and the burner (7.2.1).

- Remove six screws and remove the front of the combustion chamber.
- Clean the heat exchanger by brushing from below and through the draught diverter openings. Do not attempt to clean the internal waterways without consulting the manufacturer.
- Replace in reverse order.

#### 7.2.3 Clean the pilot assembly

- Remove pilot clamp screw (A fig. 21)
- Remove pilot tube. Blow through tube to remove dust.
- Carefully unscrew the nut retaining the pilot injector (E fig. 21) taking care not to lose the injector which is in the form of a small washer using a 8 mm or adjustable spanner. Clean the injector by blowing also clean pilot filter.
- Do not attempt to clean pilot injector by pushing wire through the orifice.

#### 7.2.4 Remove gas section

- With burner removed as described in 7.2.1
- Remove control panel as described in 7.3.2.
- Release two screws securing gas section to water section (A fig. 22).
- Ease gas section forward and up.

### 7.2.5 Clean diaphragm spindle

With gas section removed (see fig. 23) start pump. The bearing plate spindle A will rise. Whilst in this position clean and apply coat of silicone grease.

Re-assemble in reverse order.

### 7.2.6. To clean thermocouple and electrode

- Remove manifold as in 7.2.1
- Release thermocouple from thermoelectric valve (A fig. 24).
- Pull off tab connectors from overheat thermostat.
- Pull off electrode cable from piezo ignitor.
- Slide thermocouple support bracket from slot in burner.
- Clean by brushing.
- Re-assemble in reverse order.

## 7.3 General service

### 7.3.1 Clean burner, heating body, pilot assembly and thermocouple as detailed in 7.2.1. and 7.2.6.

### 7.3.2 To remove electrical control module (fig. 10)

- Isolate electrical supply.
- Withdraw fuses.
- Remove two screws left hand front of module and open the left hand side front by pulling forward.
- Unplug pump from printed circuit board.
- Disconnect and remove mains input cable.
- Remove split pin and withdraw thermostat phial.
- Remove two screws on bracket at base.
- Pull off electrode lead from piezo unit.
- Remove two screws B either side of pilot valve knob.
- Remove nut from rear control box/control box bracket.
- Remove electrical control box by pulling forward.

### 7.3.3 To replace diaphragm

- Isolate boiler by turning off isolating valves.
- Slacken valve B in base of water section.
- Drain boiler.
- Remove control module as in 7.3.2.
- Disconnect high and low pressure tubes C from water section.
- Slacken two screws between gas section and water section. (Screw at front and at right hand side).
- Release nuts securing water section to chassis.
- Remove water section complete with diaphragm.
- Separate the top and bottom halves of the water section by removing screws E. Note the relative positions of the two halves for correct re-assembly.
- Remove diaphragm and discard. Wash out water section.
- Replace diaphragm and reposition bearing plate on top of diaphragm.
- Re-assemble in reverse order taking care to relocate upper and lower sections in original position.

### 7.3.4 To clean the gas valve (fig. 22)

- Remove the burner as in 7.2.1
- Remove the four screws B fastening the top of the gas section to the base.  
n.b. it may be found easier if the combustion chamber front cover is removed.
- Lift the gas section top off the base taking care not to lose springs and valves (C).
- Lift off gas valves.
- Do not attempt to further dismantle the valve assembly.
- Clean the valve seating and replace the gas valve facing if necessary.
- Replace in reverse order.

## 8. Replacing components

### 8.1 To replace the thermoelectric valve.

- Remove thermocouple nut.
- Unscrew valve (A fig. 24) from rear of gas section using a 35 mm or adjustable spanner.
- Withdraw thermoelectric valve.
- Replace in reverse order.

### 8.2 To replace the overheat thermostat

- Remove the two tab connections on the thermocouple leads to the overheat assembly.
- Remove two screws retaining overheat thermostat.
- Replace thermostat – use heat sink grease for better contact.
- Re-assembly in reverse order.

### 8.3 To replace piezo unit

- Remove earth tab from piezo. Pull off electrode lead.
- Unscrew plastic retainer from rear of control module.
- Withdraw piezo.
- Replace in reverse order.

### 8.4 To replace pump (fig. 24)

- Isolate electrical supply.
- Remove fuses and then the two screws securing the left hand door of the electrical control box.
- Withdraw plug from printed circuit board and earth tag.
- Remove four bolts B retaining pump head.
- Remove electrical cover from pump and remove lead n.b. The motor/impellor can be replaced with a Grundfos UPS 18/60 motor/impellor and should be set on setting 2. Should it be necessary to replace the pump during the guarantee period it can be exchanged at any builder's merchants stocking Grundfos pumps.
- Replace in reverse order.

### 8.5 To remove pump and volute (fig. 24)

- Isolate boiler and drain water, see 7.3.3 disconnect electrical supply (see 8.4).

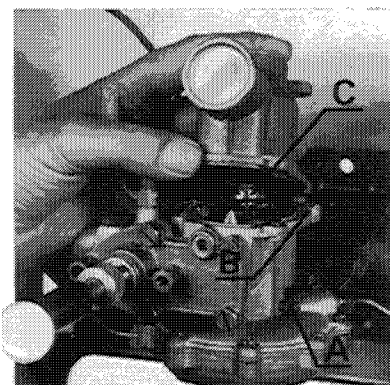

Fig. 22

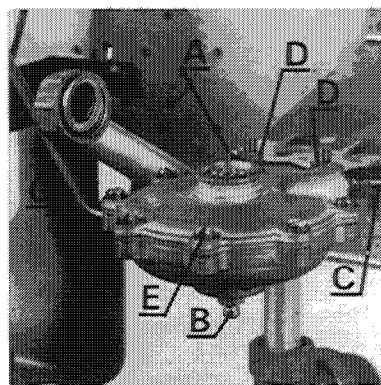

Fig. 23

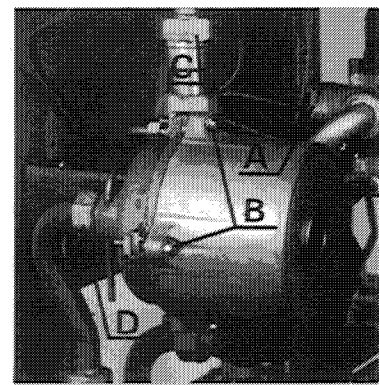

Fig. 24

- Release nut C securing volute to leg from heating body.
- Release nut D from appliance side of isolating valve.
- Replace in reverse order.

#### **8.6 To replace heat exchanger matrix (fig. 18)**

- Disconnect electrical supply.
- Isolate boiler and drain water (see 8.3.3).
- Remove six screws and remove the front of the combustion chamber.
- Release nuts A connecting heat exchanger matrix to appliance internal pipework.
- Remove four screws B securing combustion chamber to chassis (two on each side).
- Remove the combustion chamber complete with matrix.
- Unscrew the union nut and remove the left hand body leg.
- Remove two screws D at rear and two screws at front of heat exchanger matrix.
- Remove heat exchanger matrix.
- Replace in reverse order. Taking care to ensure that the flat locating bracket is in contact with heat exchanger skirt. In this position the upper union can be tightened.

#### **8.7 To replace boiler thermostat**

- Isolate electrical supply.
- Remove casing (7.1).
- Remove fuses (E fig. 18).
- Remove five screws (F fig. 18) securing control box cover.
- Remove thermostat phial (G fig. 18) from monotube after removing split pin.
- Remove thermostat with mounting plate from control box (A fig. 10).
- Detach thermostat from plate.
- Replace in reverse order.

## 9.

## Fault finding chart

Fault	Possible cause	Remedy
<b>Pilot will not light</b>	1) Gas supply not turned on. 2) Gas supply pipes not purged of air. 3) Blocked pilot filter or injector.	Turn on. Purge. Clean or replace (7.2.3).
<b>Pilot goes out when gas knob is released</b>	1) Gas control knob not fully held in before releasing. 2) Thermocouple not in tip of pilot flame. 3) Pilot flame too soft. 4) Faulty thermocouple or union loose. 5) Main gas valve not purged. 6) Faulty thermoelectric valve. 7) Overheat failing. 8) Loose connection on overheat thermostat.	Press firmly before releasing. Adjust (12 milli-volts min. required measured at high limit thermostat). Tighten pilot injector securing nut (7.2.3). Replace or tighten. Repeat ignition sequence. Replace (8.1). Replace (8.2). Tighten.
<b>Main burner will not light or lights at low flame</b>	1) Electricity not switched on to boiler. 2) Fuses missing or blown in control box. 3) Boiler thermostat at low setting. 4) Boiler thermostat faulty or not plugged into control box. 5) Gas supply insufficient. 6) Lack of water in system. 7) Air in system. 8) Boiler pump faulty. 9) Water filter in return pipe blocked or high pressure and balancing tubes blocked. 10) Bearing plate spindle bent or dry. 11) Diaphragm split or stretched. 12) Heat exchanger blocked.	Switch on. Replace 1 amp. Turn up fully. Replace or check connection (8.7). Check working pressure-8 in w.g. required at inlet. Fill. Purge. Check or replace (8.4). Remove and clean. Replace or grease (7.2.5). Replace (7.3.3). Descale or replace (8.6).
<b>Complaints of noise</b>	1) Over-gassed. 2) Air in system. 3) Boiler thermostat wrongly set or faulty. 4) Water section sticking open. 5) Gas valve sticking open. 6) Dirt/swarf on gas valve facing. 7) Resistance to water flow. 8) Pump noise or vibrating. 9) Heat exchanger partially blocked.	Check gas rate and adjust (6.5). Purge. Check flow temperature. Check operation and grease (7.2.5). Clean or grease (7.3.4). Clean and reassemble (7.3.4). Open valves. Replace or refit (8.4). Clean heat exchanger and check system (8.6).
<b>Excessively noisy burner</b>	1) Over-gassed. 2) Dirty burner bars. 3) Burr on injectors.	Check gas rate (see 6.5). Clean (7.2.1). Remove or replace.
<b>Frequent sooting of heat exchanger and burners</b>	1) Linting. 2) Insufficient combustion air to room or compartment. 3) Heat exchanger fins blocked. 4) Restriction in flue. 5) Wrong injectors fitted.	Clean burner (7.2.1). Check requirements (3.5.2). Remove and wash thoroughly (7.2.2). Check flue. Check and replace (2.10)
<b>Gas staying on after pump is switched off</b>	1) High pressure or balancing tubes blocked. 2) Gas valve sticking open. 3) Water section sticking open.	Remove and clean. Clean and grease (7.3.4). Clean and grease (7.2.5).

Chaffoteaux et Maury Limited,  
Trench Lock, Trench, Telford, Shropshire TF1 4SZ  
Telephone: (01952) 222727 Fax: (01952) 243493

