

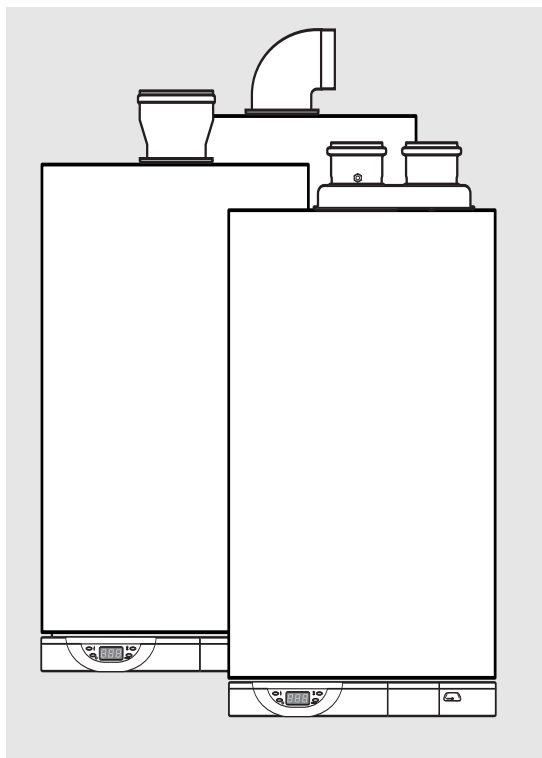

CONDENSING WALL HUNG COMBINATION BOILER

Heating and Instantaneous Domestic Hot Water with TSS[®]
Fanned Flue System

Installation and Operating Instructions



Calydra green 24
Calydra green 30

Manufactures N°

200906823037.31

200906826037.31

Model Type

Calydra green 24 Nat

Calydra green 30 Nat

Gas Council N°

47-980-25

47-980-26



These instructions are suitable for the CALYDRA GREEN boilers :

Do not forget the Log Book

Chaffoteaux & Maury supports Benchmark, the heating industry code to ensure the correct installation, commissioning and servicing of domestic central heating systems.

To The Householder

Make sure you have a completed Log Book for your boiler. This provides a record of the commissioning of your boiler.

It contains important information about your particular installation that may be required by service engineers. The Log Book will also provide contact details for the installer should you need guidance in the use of this appliance or if there are any problems.

As with your car, your boiler will work more reliably and efficiently if regularly serviced. We recommend an annual service check. The service history of the appliance will be recorded on the Log Book.

In the unlikely event of any problems with your boiler or system you should first contact your installer. If your installer cannot resolve the problem he should telephone our national service helpline.

A charge may be made if Chaffoteaux & Maury Service is called out to resolve a non-product related fault.

Your statutory rights are not affected.

**TO CONTACT C&M SERVICE, PLEASE CALL THE NATIONAL WARRANTY HELPLINE ON:
0 870 600 9888**

To The Installer

As part of the commissioning of this appliance it is vital that the Log Book is completed and given to the Householder. Please ensure that your customer is aware of the importance of keeping the Log Book safe as a record of the installation and the appliance service history.

Please ensure that your customer is aware of the correct operation of the system, boiler and controls.

CUSTOMER CARE

Chaffoteaux & Maury Ltd., as a leading manufacturer of domestic and commercial water heating appliances is committed to providing high quality products and a high quality after sales service. If it is necessary to contact an engineer, then telephone the national warranty helpline 0870 600 9888.

Advice on installation or servicing can also be obtained by contacting the Technical Department.on:

Tel: 0870 241 8180

Fax: 01494 459775

GUARANTEE

The manufacturer's guarantee is for 12 months from the date of purchase. The guarantee is invalidated if the appliance is not installed in accordance with the recommendations made herein or in a manner not approved by the manufacturer. To assist us in providing you with an efficient after sales service, please return the guarantee registration card enclosed with the boiler without delay.

STATUTORY REQUIREMENTS

The installation of this appliance must be carried out by a CORGI Registered person or other competent person and in accordance with the requirements of the Gas Safety (Installation and Use) Regulations.

In addition, the installation must also comply with the current bylaws of Local Water Undertakings, Building Regulations, IEE Wiring Regulations, Local Authority Building Standards (Scotland) Regulations and the Safety Document 635 The Electricity at work Regulation. The appliance named below does not contain any asbestos or asbestos products, or mercury

derivatives. Additional CFC's have not been used in this product.

The appliance does not contain any potential hazard in relation to the COSHH regulations.

It should also be carried out in accordance with current editions of the following British Standards Codes of practice: BS 6891, BS 5440 parts 1 and 2, BS 5449 part 1, BS 7593, BS 6798, BS 5546, BS 4814, BS 7074 part 1 and 2, BS 7671 and BG DM2.

If there is a possibility of the incoming mains water pressure exceeding 10 bar then a suitable pressure limiting valve must be fitted where pressures exceed 6 bars a pressure limiting is preferred.

Precautions: During servicing, keep the dust generation to a minimum and avoid inhaling any dust and contact with the skin and eyes. Normal handling and use will not present any discomfort, although some people with a history of skin complaints may be susceptible to irritation. When disposing of the ceramic lining, ensure that it is securely wrapped and wash hands after contact.

Contents

CUSTOMER CARE		Page
Guarantee		2
Statutory Requirements		2
Contents		3
INTRODUCTION		4
INSTALLER'S INSTRUCTION		5
1 DESCRIPTION		5
2 DIMENSIONS		6
3 HYDRAULIC DATA		6
4 INSTALLATION REQUIREMENTS		7
Location		7
Flue		7
Ventilation		7
Gas Supply		7
Electrical Supply		7
Showers		7
Flushing and Water Treatment		7
System Controls		7
5 INSTALLING THE BOILER		8
Method of positioning the boiler on th wall.....		8
Connecting the boiler to the system.....		8
Safety valve and condensats drains		8
Fitting the horizontal flue		8
6 ELECTRICAL CONNECTIONS		10
Making the Electrical Connections		10
7 COMMISSIONING AND TESTING		10
Pre-commissioning		10
DHW		10
Central Heating		10
Lighting the boiler.....		10
By pass and pump		11
Post Commissioning		11
Handing over to the Householder		11
8 FITTING THE CASING		11
9 ADJUSTEMENTS AND SETTINGS		12
10 INCORRECT FUNCTION		17
11 GAS CONVERSION		17

USER'S INSTRUCTIONS

	Page
12- CONTROL PANEL	18
13- HOW TO USE	19
Switching on	19
Switching on Central heating	19
Switching on the Domestic Hot water	19
Switching on the Domestic Hot water and Central Heating together	19
Stand by mode	20
Turn off the boiler	20
14 MAINTENANCE	20
15 GUARANTEE	20
16 PRACTICAL INFORMATION	20
17 GAS CONVERSION	21
18 INCORRECT FUNCTION	21
19 TECHNICAL DATA	22

This instruction booklet is especially designed for appliances installed in the United Kingdom and the Republic of Ireland

INTRODUCTION

The **CALYDRA GREEN** is a fully automatic, wall mounted, low water content condensing combination boiler. It is a room sealed, fan assisted, balanced flued appliance providing central heating and mains pressure domestic hot water on demand. It has electronic ignition and is suitable for all modern electrical control systems. The boiler is designed for sealed systems only and a circulating pump, expansion vessel together with a pressure gauge and safety valve are included within the boiler.

The standard horizontal flue kit is suitable for lengths 300 mm minimum to 600 mm maximum and includes an elbow adapter that can be rotated through 360°. The horizontal flue can extend up to 3 metres using 1 metre flue extension kits. 45° and 90° flue bends are also available as accessories.

INSTALLER'S INSTRUCTIONS

1

Description

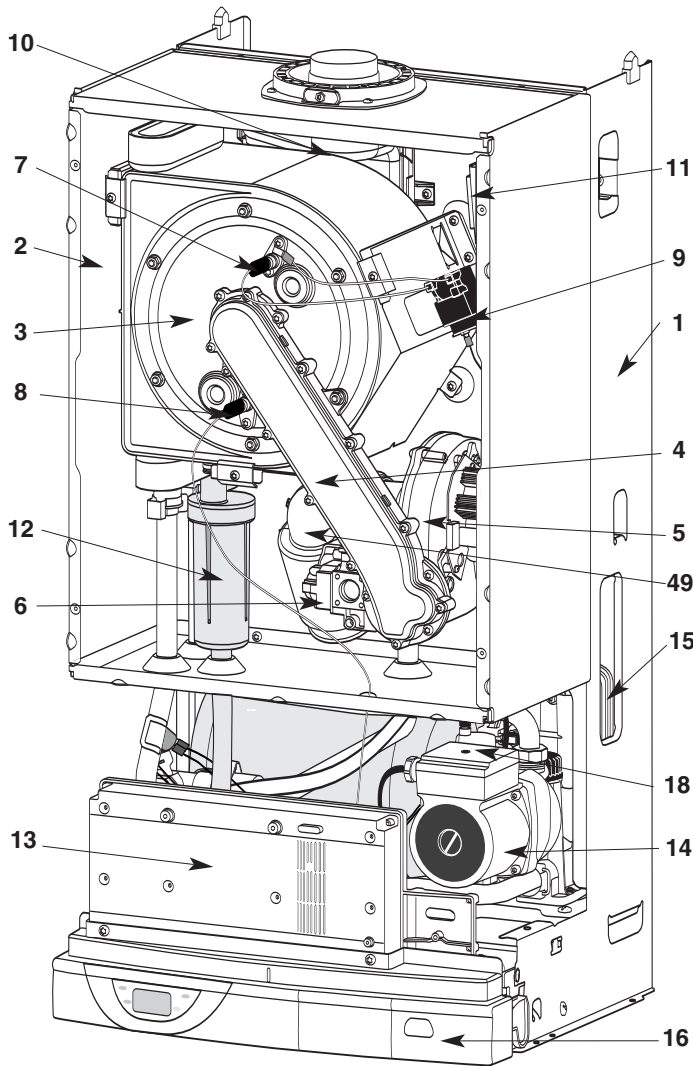

Fig. 1

- 1.- Steel chassis complete with expansion vessel
- 2.- Sealed chamber
- 3.- Burner and heat exchanger assembly
- 4.- Air / gas connection
- 5.- 24 V modulating fan
- 6.- Gas valve
- 7.- Ignition electrode
- 8.- Ionisation probe
- 9.- Ignitor
- 10.- Combustion products manifold
- 11.- 24 V transformer
- 12.- Siphon
- 13.- Electrical box
- 14.- Pump
- 15.- Secondary heat exchanger
- 16.- Pressure gauge
- 17.- Three way valve
- 18.- Automatic air separator and automatic vent
- 19.- Central Heating flow switch
- 20.- Domestic Hot Water flow switch
- 21.- Central heating control thermistor
- 22.- Hot water control thermistor
- 23.- TSS Control thermistor
- 24.- Overheat sensor
- 25.- TSS® (mini cylinder)
- 26.- DHW pressure relief valve
- 49.- Silencer.

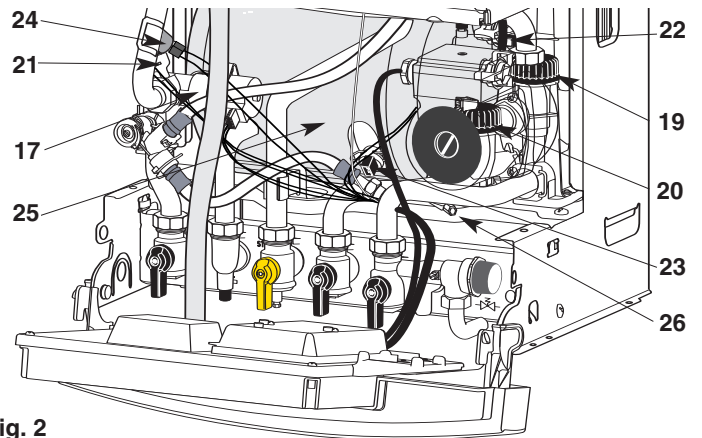

Fig. 2

- 27.- Display
- 28.- Domestic Hot Water switch
- 29.- Green indicator – Domestic Hot Water mode ON
- 30.- D.H.W. temperature reducing key
- 31.- D.H.W. temperature increasing key DHW mode indicator
- 32.- Central Heating switch
- 33.- Green indicator – Central Heating mode ON
- 34.- Central Heating temperature reducing key
- 35.- Central Heating temperature increasing key
- 36.- Green indicator – Power ON
- 37.- Orange indicator - Burner ON
- 38.- Red indicator - Lock out / flame failure
- 39.- Reset key

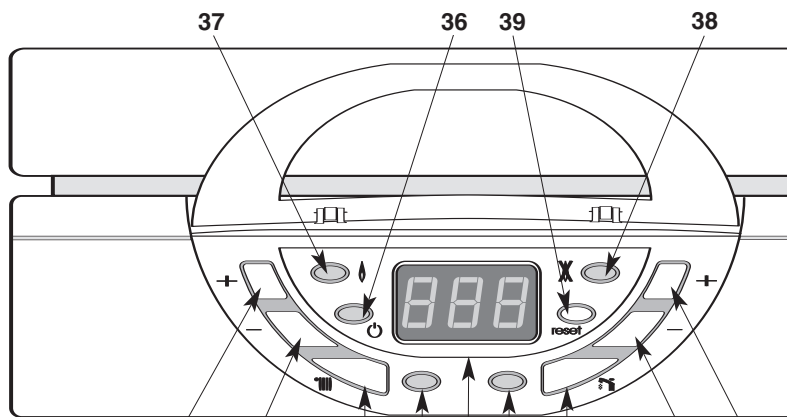
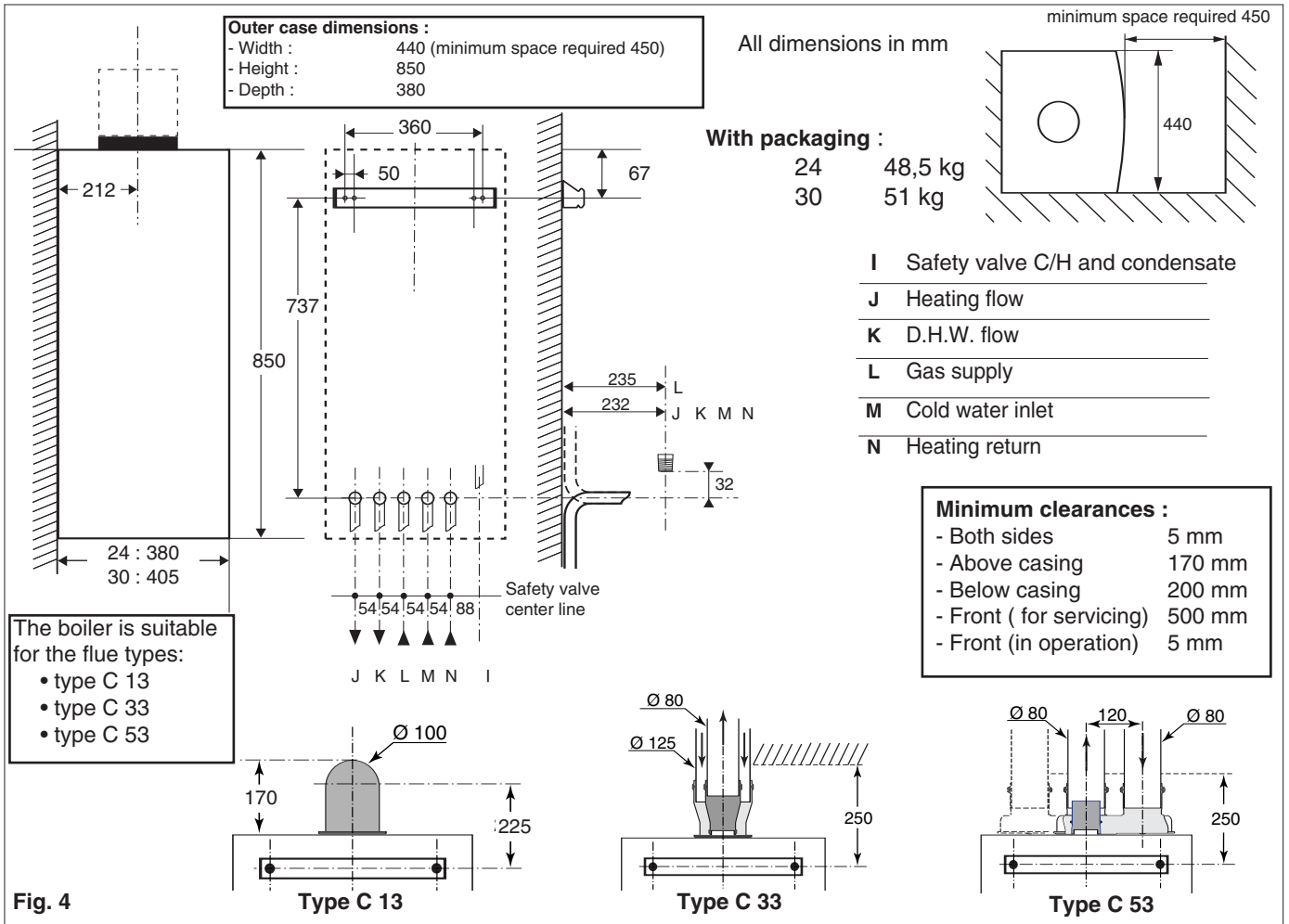

Fig. 3

35 34 32 33 27 29 28 30 31

2

Dimensions



3

Hydraulic Data

Pump head available

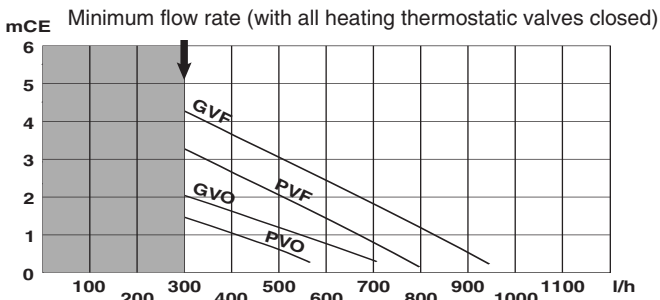

The boiler comprises a double speed pump and an adjustable by-pass.

The chart (fig. 5) shows the pump head available regarding the flow rate. GVF means high speed by-pass closed, PVF means low speed by-pass closed, GVO means high speed by-pass fully open, PVO means low speed by-pass fully open.

For adjustment procedure, please refer to Section 8.

The minimum flow rate to ensure the correct functioning of the boiler should be over 300 l/h (with thermostatic valves fully closed).

Maximum water capacity of Central Heating system :

The expansion vessel is pre-charged to 0.7 bar (10 lb/in²).

The vessel is suitable for systems up to 145 litres capacity.

For systems of a greater capacity an additional expansion vessel will be required. Refer to the chart (**Fig. 6**) and BS 7074 pt 1 or BS 5449.

The minimum initial pressure of the system should be over 0.7 bar (1 to 1.5 bar is recommended).

Pump head chart available at the outlet of the boiler
Central heating initial pressure when cold (in bar)

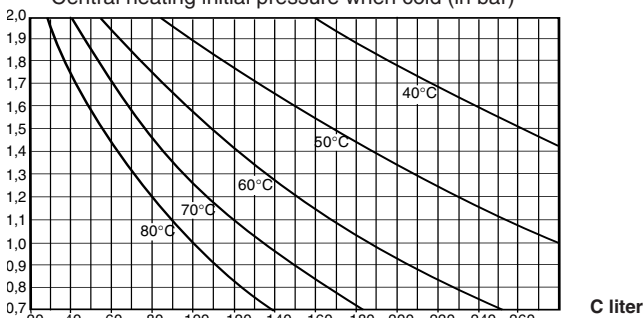

System capacity chart

Fig. 6

Location

The boiler can be installed on any suitable internal wall. Provision must be made to allow the correct routing of the flue and siting of the terminal to allow the safe and efficient removal of the flue products. A compartment or cupboard may be used provided that it has been purpose-built or modified for the purpose. It is not necessary to provide permanent ventilation for cooling purposes. Detailed recommendations are given in BS 5440 pt 2. If it is proposed that it is installed in a timber framed building then reference must be made to British Gas Document DM2, or advice sought from CORGI.

Avoid installing the boiler where the air inlet can be polluted by chemical products such as chlorine (swimming pool area), or ammonia (hair dresser), or alcalin products (launderette).

Flue

Detailed information on the flue assembly is contained in the appropriate starter pack.

The boiler must be installed so that the flue terminal is exposed to the free passage of external air at all times. It must not be allowed to discharge into another room or space such as an outhouse or closed lean-to. The minimum acceptable clearances are shown below:

- A Directly below an opening, window, etc	300 mm
- B Above an opening, window, etc	300 mm
- C Horizontally to an opening, window, etc	300 mm
- D Below gutters, soils pipes or drain pipes	75 mm
- E Below eaves	200 mm
- F Below balconies or car port roof	200 mm
- G From a vertical drain pipe or soil pipe	150 mm
- H From an internal or external corner	300 mm
- I Above ground roof or balcony level	300 mm
- J From a surface facing the terminal	600 mm
- K From a terminal facing the terminal	1200 mm
- L From an opening in the car port into the dwelling	1200 mm
- M Vertically from a terminal on the same wall	1500 mm
- N Horizontally from a terminal on the same wall	300 mm
- Q Fixed by Ubbink Rolux 4 GM flue terminal	

It may be necessary to protect the terminal with a guard. Reference should be made to the Building Regulations for guidance. Suitable guards may be obtained from the following manufacturer:

Quinnel Barret & Quinnel Wireworks
Old Kent Road
London SE15 1NL
Tel: 0171 639 1357

Ventilation

The room in which the boiler is installed does not require specific ventilation. **If it is installed in a cupboard or compartment permanent ventilation is not required for cooling purposes.**

Gas Supply

The gas installation and soundness testing must be in accordance with the requirements of BS 6891. The boiler requires a 22 mm supply. Ensure that the pipe size is adequate for demand including other gas appliances on the same supply.

Combustion system protection

The sulphur level contained in the gas should comply with the European Standards which are :

- maximum 150 mg/m³ for a short period in a year
- average level of 30 mg/m³ during one year

Electrical Supply

The appliance requires an earthed 230V - 50 Hz supply and must be in accordance with current I.E.E. regulations. It must also be possible to be able to completely isolate the appliance electrically. Connection should be via a 3 amp

fused double-pole isolating switch with contact separation of at least 3 mm on both poles. Alternatively, a fused 3 Amp. 3 pin plug and unswitched socket may be used, provided it is not used in a room containing a bath or shower. It should only supply the appliance.

The boiler is suitable for sealed systems only. The maximum working pressure for the appliance is 10 bar. All fittings and pipework connected to the appliance should be of the same standard. If there is a possibility of the incoming mains pressure exceeding 10 bar, particularly at night, then a suitable pressure limiting valve must be fitted.

The boiler is designed to provide hot water on demand to multiple outlets within the property. If there is a requirement for greater demands, for example if the property has several bathrooms and cloakrooms, a vented or unvented hot water storage system may be used.

Showers

Any shower valves used with the appliance should be of a thermostatic or pressure balanced type. Refer to the shower manufacturer for performance guidance and suitability.

Flushing and Water Treatment

The performance of the appliance could be impaired by system debris or the effects of corrosion. The system must be flushed thoroughly to remove metal filings, solder, machining oils and other fluxes and greases before connecting the boiler. If it is an existing system, an appropriate flushing and descaling agent should be used. Refer to BS 7593 (1992) for guidance. For more information on the use of corrosion inhibitors, flushing and descaling agents, advice can be sought from the manufacturers of water treatment products such as:

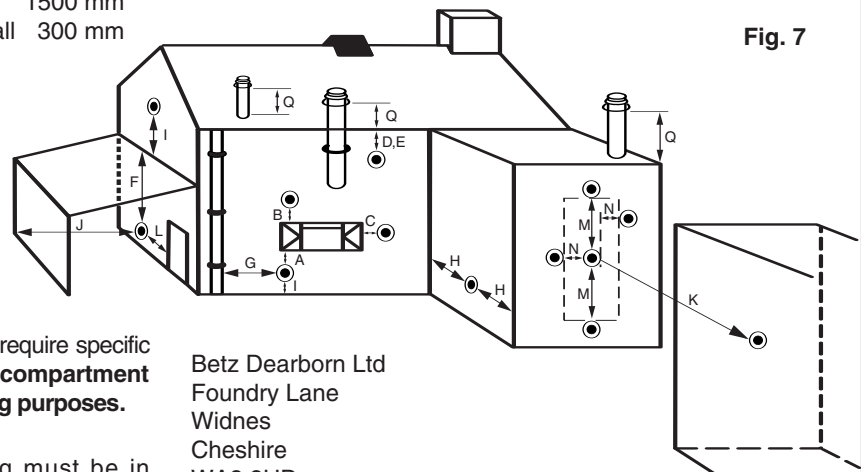

Fig. 7

Betz Dearborn Ltd
Foundry Lane
Widnes
Cheshire
WA8 8UD
Tel: 0151 424 5351
Fernox Manufacturing
Britannica Works
Clavering
Essex
CB11 4QZ
Tel: 01799 550811

System Controls

The boiler is electrically controlled and is suitable for most modern electronic time and temperature controls. The addition of such external controls can be beneficial to the efficient operation of the system. The boiler connections for external controls are 24V and so only controls of 24V or that have voltage free contacts should be used.

Please check that you are familiar with the installation requirements before commencing work (section 6).

The installation accessories described in the following list are included in the boiler packaging.

- Hanging bracket
- A paper template (showing the dimensions of the boiler with 5 mm side clearances, fitting instructions and commissioning instructions)
- Connection tails
- Screws and wall plugs
- Connection washers and filters
- Installation manual

Method of positioning the boiler on the wall.

The paper template can be used to ensure the correct positioning of kitchen cabinets etc. It also details the commissioning instructions.

The paper template has to be fixed to the wall and used to locate the position of the hanging bracket and the centre for the flue hole.

Drill and plug the wall and secure the hanging bracket using the screws provided. Remove the boiler from its packaging as shown (Fig. 8) and unscrew the 4 screws **A** and remove the casing (Fig. 9).

Place the boiler on the wall on the hanging bracket (Fig. 11).

If required, there is space for all piping to pass behind the boiler. Using (Fig. 11) for reference, connect the gas and water pipes and the valves to the base of the appliance using the tails provided. There is a 190 mm space between the valves and the wall to make these connections.

Connecting the boiler to the system

- Push in the tabs "**P**" (Fig. 13) on either side of the boiler and pivot the electrical box forward to gain access to the valve connections
- Remove the yellow caps and connect the boiler to the taps using the washers provided in the plastic bag.
- 4 x fibre washers for the C.H. flow and return, hot water outlet and cold water inlet connections
- 1 x rubber washer "**R**" for gas connection.

Provision must be made to fill and recharge the system pressure. This can be achieved using a filling loop or other methods approved by the local water authority.

Before fitting the tails onto the connecting bracket, please check the correct location of the flow restrictor **L** (Fig.10) on the main inlet.

Safety valve and condensate drains

The pressure relief valve tube is clear silicone. It should terminate below the boiler over a tundish or 22 mm pipe (see I Fig. 4) which should in turn discharge safely outside the premises. Care should be taken that it does not terminate over an entrance or window or where a discharge of heated water could endanger occupants or passers by.

External termination via condensate siphon

The condensate drainage pipe should have a minimum diameter of 22 mm and the external pipe length should not be more than 3m. The external length should be kept as short as possible to minimize the effect of freezing.

Please refer to **BS 6798 : 2000**

The system should be carefully checked for leaks, as frequent refilling could cause premature system corrosion or unnecessary scaling of the heat exchanger. The pipe from the siphon 12 (fig. 1) should be connected to a drain in the conditions described in the relevant British regulations.

Pay special attention to not bend the condensates silicone drain pipe in such a way as to cause the flow to be interrupted. Please use only drain pipe material compatible with condensate products. (refer to **BS 6798 : 2000**)

The condensate flow can reach 2 litres/hour; because of the acidity of the condensate products (Ph close to 2), take care before operation.

Fitting the Horizontal Flue

Important!! Before starting the boiler, the siphon 12 (Fig. 1) must be filled with water. Before fitting the flue terminal onto the boiler, please pour 1/4 litre of water in the exhaust pipe as shown (Fig. 12).

The instructions for the vertical and biflux (twin pipe) flue options are included with the relevant adapter kits.

The standard flue supplied with the appliance is suitable for lengths from 300 mm minimum to 720 mm maximum.

This means for rear flueing, the standard kit will accommodate a maximum wall thickness of 600 mm, and for side flueing a maximum wall thickness of 587 mm. This takes into account the minimum appliance side clearances of 5 mm.

If the flue is a side exit installation, then calculate the position of the hole with a slope of 5 mm / metre towards the boiler from the terminal. The flue should rise up slightly to the terminal in order to let the condensate come back into the boiler.

Attention ! Use only specific condensation flue kit.

5

Installing the Boiler (continued)

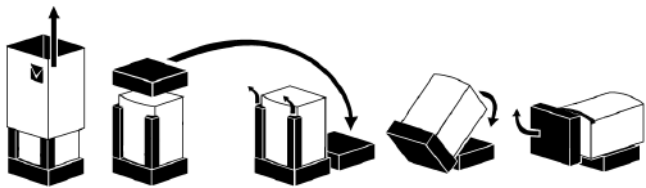

Fig. 8

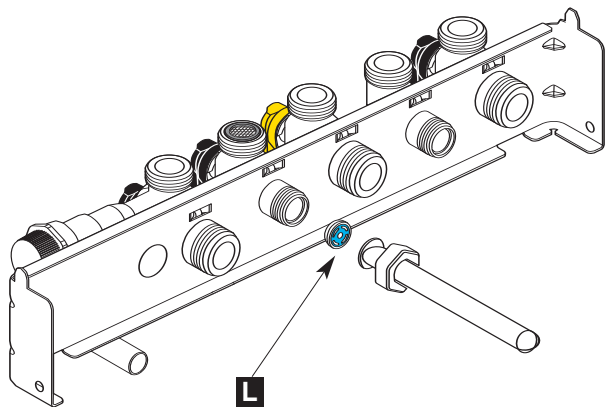

Fig. 10

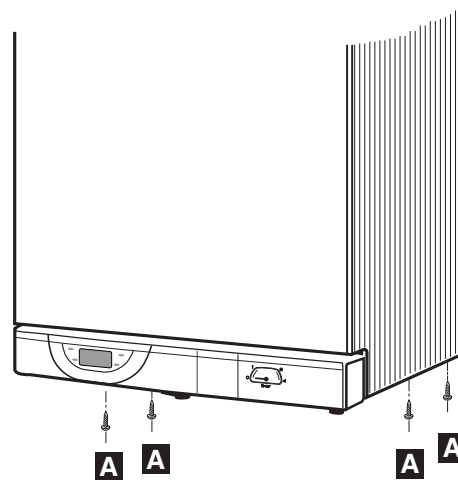

Fig. 9

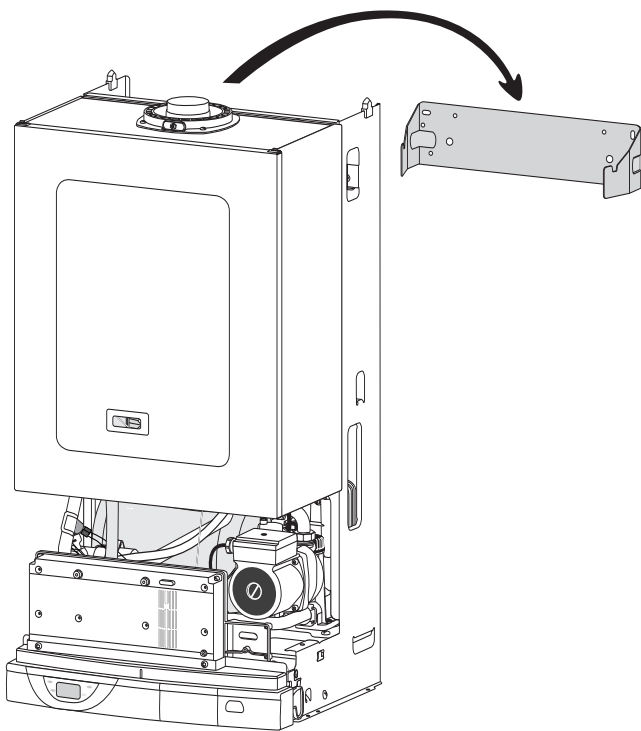

Fig.11

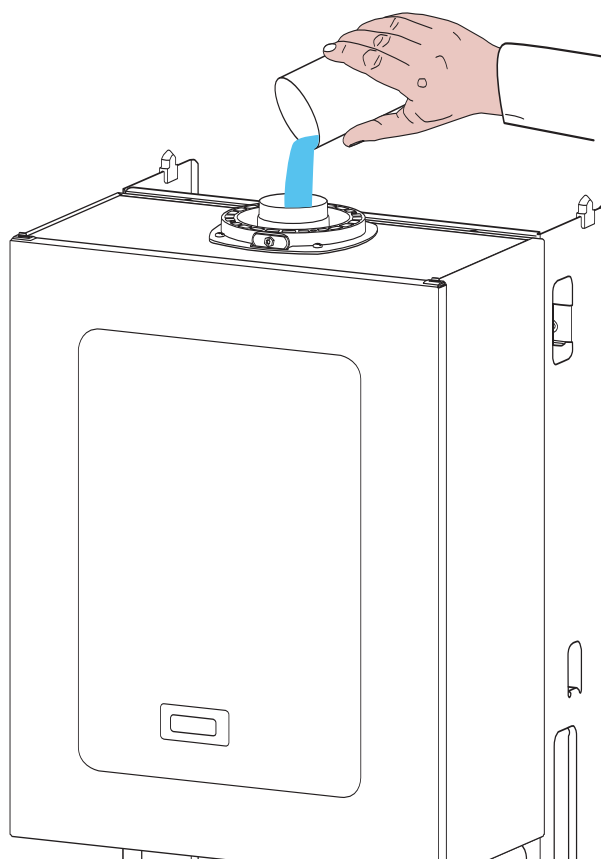

Fig.12

6

Electrical Connections

Making the Electrical Connections

Hinge down the electrical box to gain access to the electrical connections. Push in the tabs **P** (Fig. 13) on either side of the boiler and pivot the box forward. Undo the two retaining screws **V**, remove the cover and remove the cable clamp **C** (Fig. 14).

Connect the live and neutral wires to the multipin plug leaving sufficient earth wire to connect to the earthing point **T** (Fig. 14).

Note: The connections should be made so that should the lead be pulled from its anchorage, the current carrying wires become taut before the earth wire.

If using a room thermostat or other external control, they can be connected in place of the link **S** on the multipin plug (see Fig. 14).

Note: Use only controls designed for voltage free switching or a 24V supply. Do not connect to a 230V supply.

Connect the multipin plug into the socket on the printed circuit board. Secure the cable using the cable clamp and replace the cover. **NB:** The room thermostat options setting can be made before replacing the electrical box cover **J1** (Fig. 14).

All necessary settings for room thermostat operations are described in **Section 9 ADJUSTMENTS AND SETTINGS**.

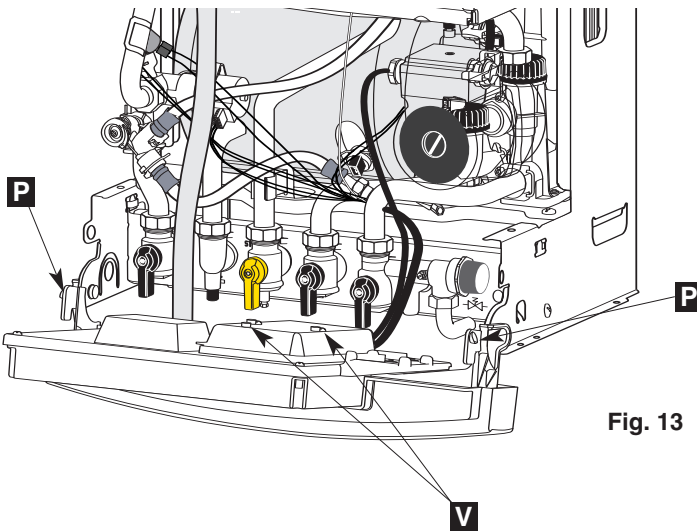

Fig. 13

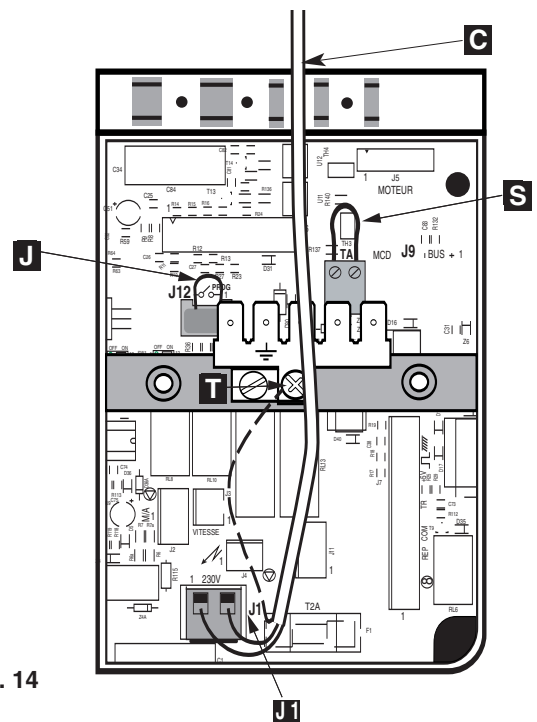

Fig. 14

7

Commissioning and Testing

Pre-commissioning

Ensure that the system has been adequately flushed.
Purge gas supply of air and test for soundness.
Carry out final electrical tests to ensure the correct polarity and earthing continuity.

DHW

Open the main cold feed valve **43**.
Open all hot taps to purge the DHW system.
Check for water soundness.
Check flow rate at the bath tap is set correctly (see technical data).

Central Heating

Open the flow and return valves on the boiler **40** and **44** (Fig. 15)
Open the automatic air vent **18** (Fig. 2)
Fill the system and vent radiators.
Set the system pressure and remove the filling loop.
Check for leaks.
Manually check pump is free to turn.
Switch on electrical supply.
Press on Central Heating switch **29** (Fig. 3) to switch on the heating mode.
Press the + key **32** (Fig. 3) to set the heating temperature to

maximum.

Allow the pump to run for several minutes.
Isolate the electrical supply.
Drain boiler and check water filter for installation debris.
Replace filter and recharge system.

Lighting the Boiler

Connect gas pressure gauge to test point **42** (Fig. 15).
Turn on the gas supply and boiler gas tap **42** (Fig. 15).
Ensure the electrical supply is on.
Ensure all the external controls are calling for heat.
Press on Central Heating switch **29** (Fig. 3) to switch on heating mode.
Press on + key **32** (fig 3) to set heating temperature to maximum.
The boiler will light. Allow the boiler to heat the system.
Check the inlet gas pressure (working pressure) while boiler is operating in hot water mode. (Refer to technical data).
Check the operation of the boiler controls and safety devices. (see separate servicing leaflet for details). Set the by-pass (refer to the paragraph Page 11).
Re-flush the system to remove any dissolved oils and fluxes.
Recharge the system pressure and introduce any water treatment as required.

7

Commissioning and Testing (continued)

By-Pass and Pump

The boiler is fitted with a pre-adjusted by pass. Although adjustment is not normally necessary, the by-pass can be reset by turning screw **D (Fig. 15)** anti-clockwise to open the by-pass using the chart (**Page 6, Fig. 5**) for guidance. If used on a system with thermostatic radiator valves, the flow rate with the thermostatic valves closed should be adjusted to at least 300 l/hr. The aforementioned chart indicates the residual head of the pump available for the system. The pump fitted on the boiler is a double speed model. (GV = High speed and PV = low speed). The speed setting is described in **Section 10**. Speed selection is only available in C.H. mode.

Post Commissioning

Ensure system pressure has been set correctly.
 Set all parameters of the boilers as shown in **Section 9 ADJUSTMENTS AND SETTINGS**.
 Set boiler thermostat and controls.
 Set programmer to householder's requirements.
 Set external controls.
 Ensure the Log Book is fully completed with your contact details and required readings and details of the installation.

Handing Over to the Householder

Demonstrate the lighting and operation of the boiler.
 Demonstrate how to maintain the system pressure.
 Demonstrate the operation and setting of the built-in clock.
 Explain the benefits of annual maintenance by a competent person.
 Explain how to register guarantee.
 Ensure the Householder countersigns the Log Book to confirm that these demonstrations have been carried out and understood.

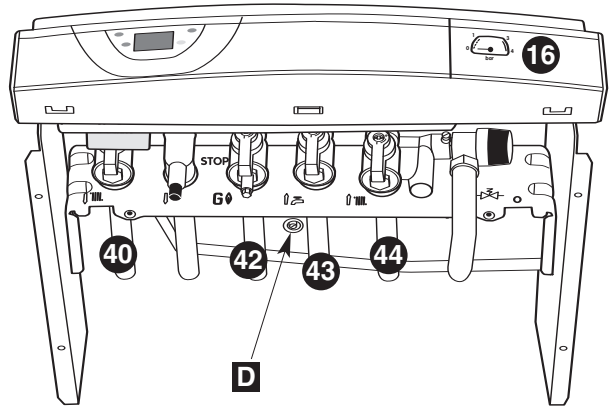

Fig. 15

8

Fitting the Casing

Fitting the casing

- Remove the protecting film from the casing :
- Position the casing as shown (**Fig. 17**)
 - Slide down the casing and put the casing holes on the plastic pins located on the top of the chassis
 - Check the correct position of the casing onto the boiler
 - Tighten the 4 screws located at the bottom as shown in (**Fig. 16**).

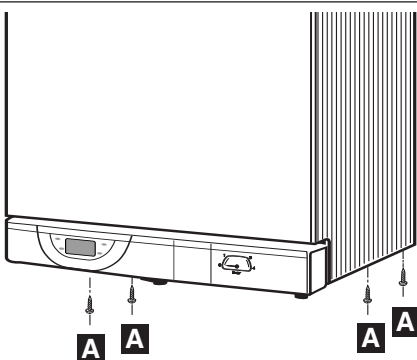

Fig.16

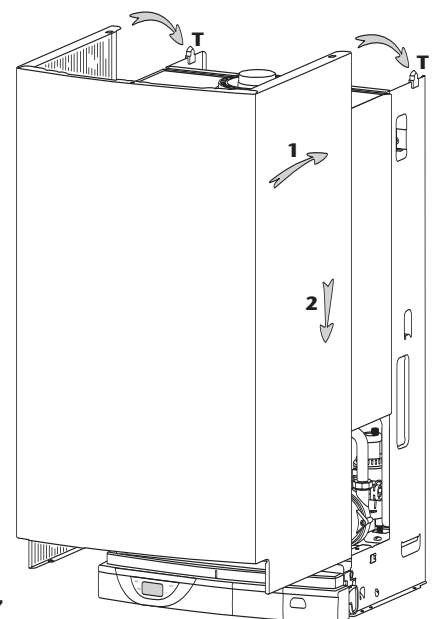

Fig. 17

The boiler is delivered with pre-set values described in menus 3 and 4.

All settings can be changed by the installer or a qualified person. To gain access to the setting keys, open the front door **P** (Fig. 18)

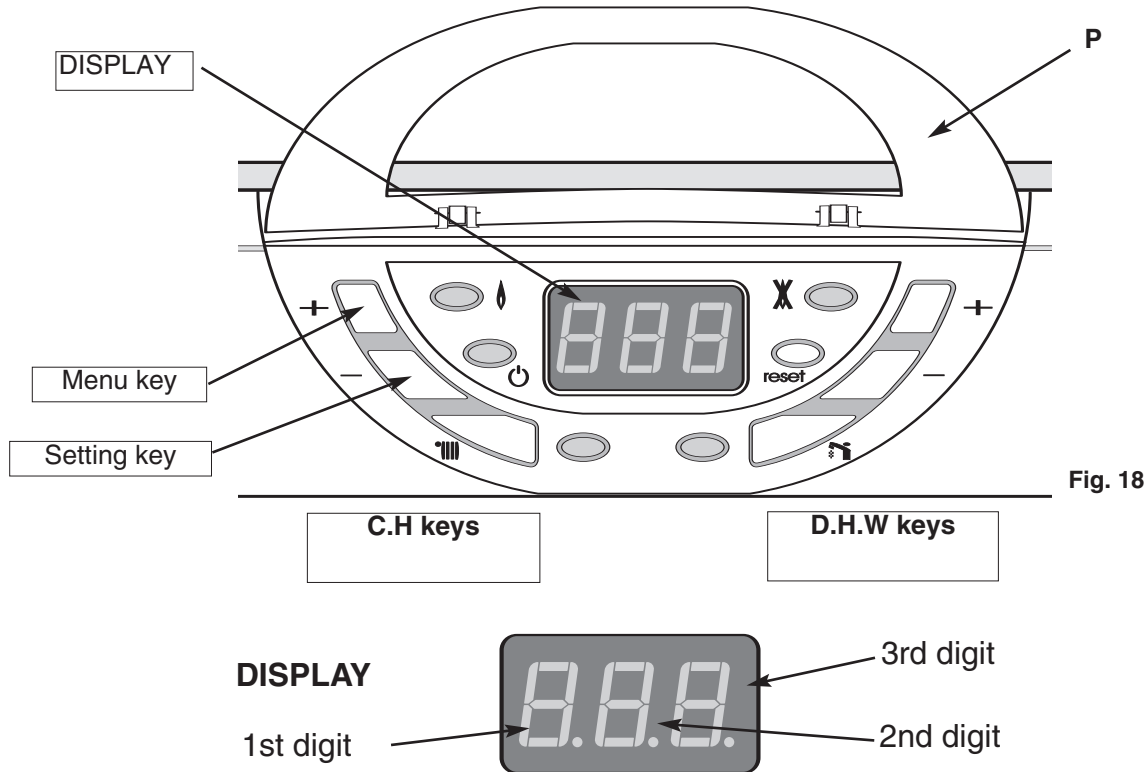

Fig. 18

To gain access to the setting menus press both the \ominus and \oplus keys on the D.H.W. side for 5 seconds. (Fig. 18). Menu 1 is displayed.

Changing the menu :

Press the Menu key (\oplus key on C.H. side) (Fig.18). The menu number is displayed for 3 seconds. Press the menu key to change to the next menu.

Changing section in a menu (available only for menu 3 and 4) :

Press either the \oplus or \ominus key on the DHW side to change from one section to the previous or the next one in a menu.

Note: When you arrive at the last section of a menu, pressing the \oplus key will change to the the 1st section. When you are at the first section, pressing the \ominus key will change to the last section of the menu.

Setting a parameter in a section:

Press the setting key (\ominus key of the C.H. side) to enter the modification mode. The 2nd and 3rd digits will flash. Press the \oplus or \ominus keys on the DHW side to select the correct value then press the Setting key to accept this modification and to exit the setting mode. The 2nd and 3rd digits will stop flashing.





Recalling the basic configuration:



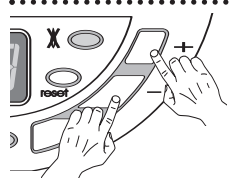
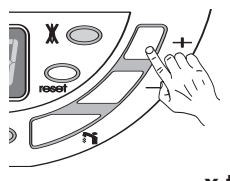
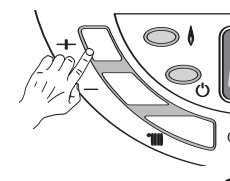
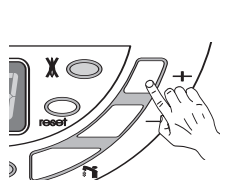
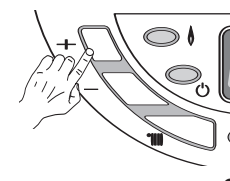
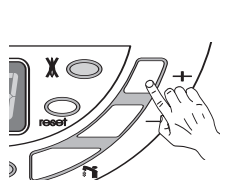

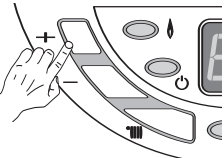

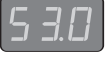

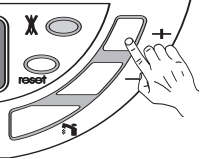

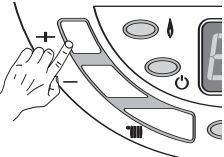



Select menu 3 or 4 then press both the \oplus key on the DHW side and the setting key for more than 5 seconds. The digits will flash **CM** [7 7] for a while to indicate that the operation is completed.

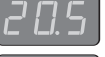

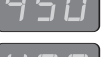
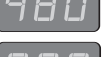
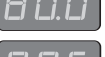





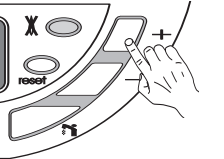

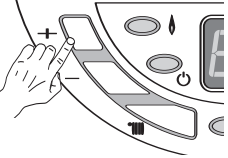

Erasing the default register :

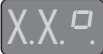
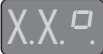
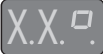
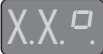
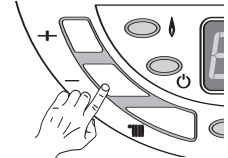
Select menu 1 then press both the \oplus key DHW side and setting key for more than 5 seconds. The digits will flash **CM** [7 7] for a while to indicate that the operation is completed. **Note:** To exit from the setting mode, leave the boiler for approx. 1 minute, the boiler will then revert to the user mode.

ACTION	CONFIGURATION	DISPLAY																															
 <p>5 "</p>  <p>x times</p>  <p>once</p>  <p>x times</p>	<p style="text-align: center;">Menu - 1 - Default register Records the last 10 defaults</p> <table border="1" data-bbox="422 302 1332 627"> <thead> <tr> <th>Section</th> <th>Digit 1</th> <th>Digits 2 and 3</th> </tr> </thead> <tbody> <tr> <td>Last default occurred</td> <td>0.</td> <td>code from 01 to 99</td> </tr> <tr> <td>Last but one default occurred</td> <td>1.</td> <td>code from 01 to 99</td> </tr> <tr> <td>...</td> <td>...</td> <td>code from 01 to 99</td> </tr> <tr> <td>Last default occurred before the previous one</td> <td>9.</td> <td>code from 01 to 99</td> </tr> </tbody> </table> <p>Note -- is displayed if no default is recorded.</p>	Section	Digit 1	Digits 2 and 3	Last default occurred	0.	code from 01 to 99	Last but one default occurred	1.	code from 01 to 99	code from 01 to 99	Last default occurred before the previous one	9.	code from 01 to 99	<p style="text-align: center;">- 1 -</p> <p style="text-align: center;">0 . .</p> <p style="text-align: center;">1 . .</p> <p style="text-align: center;">9 . .</p>																
Section	Digit 1	Digits 2 and 3																															
Last default occurred	0.	code from 01 to 99																															
Last but one default occurred	1.	code from 01 to 99																															
...	...	code from 01 to 99																															
Last default occurred before the previous one	9.	code from 01 to 99																															
 <p>once</p>  <p>x times</p>	<p style="text-align: center;">Menu - 2 - Boiler conditions Indicates the conditions or the configurations of the boiler</p> <table border="1" data-bbox="422 907 1332 1635"> <thead> <tr> <th>Section</th> <th>Digit 1</th> <th>Digits 2 and 3</th> </tr> </thead> <tbody> <tr> <td>Software version of display PCB</td> <td>0.</td> <td>10 to 99</td> </tr> <tr> <td>Flue type</td> <td>2.</td> <td>1 : FF variable speed</td> </tr> <tr> <td rowspan="2">Room thermostat is calling for heat</td> <td>3.</td> <td>0 : no</td> </tr> <tr> <td>3.</td> <td>1 : yes</td> </tr> <tr> <td rowspan="2">Theoretical position of the 3 way valve</td> <td>4.</td> <td>0 : DHW</td> </tr> <tr> <td>4.</td> <td>1 : CH</td> </tr> <tr> <td>DHW flow temperature in Celsius degrees</td> <td>5.</td> <td>from 00 to 99</td> </tr> <tr> <td>TSS[®] temperature in Celsius degrees</td> <td>6.</td> <td>from 00 to 99</td> </tr> <tr> <td>CH flow temperature in Celsius degrees</td> <td>7.</td> <td>from 00 to 99</td> </tr> <tr> <td>Software version of main PCB</td> <td>9.</td> <td>10 to 99</td> </tr> </tbody> </table>	Section	Digit 1	Digits 2 and 3	Software version of display PCB	0.	10 to 99	Flue type	2.	1 : FF variable speed	Room thermostat is calling for heat	3.	0 : no	3.	1 : yes	Theoretical position of the 3 way valve	4.	0 : DHW	4.	1 : CH	DHW flow temperature in Celsius degrees	5.	from 00 to 99	TSS [®] temperature in Celsius degrees	6.	from 00 to 99	CH flow temperature in Celsius degrees	7.	from 00 to 99	Software version of main PCB	9.	10 to 99	<p style="text-align: center;">- 2 -</p> <p style="text-align: center;">0 . .</p> <p style="text-align: center;">2 . 1</p> <p style="text-align: center;">3 . 0</p> <p style="text-align: center;">3 . 1</p> <p style="text-align: center;">4 . 0</p> <p style="text-align: center;">4 . 1</p> <p style="text-align: center;">5 . .</p> <p style="text-align: center;">6 . .</p> <p style="text-align: center;">7 . .</p> <p style="text-align: center;">9 . .</p>
Section	Digit 1	Digits 2 and 3																															
Software version of display PCB	0.	10 to 99																															
Flue type	2.	1 : FF variable speed																															
Room thermostat is calling for heat	3.	0 : no																															
	3.	1 : yes																															
Theoretical position of the 3 way valve	4.	0 : DHW																															
	4.	1 : CH																															
DHW flow temperature in Celsius degrees	5.	from 00 to 99																															
TSS [®] temperature in Celsius degrees	6.	from 00 to 99																															
CH flow temperature in Celsius degrees	7.	from 00 to 99																															
Software version of main PCB	9.	10 to 99																															

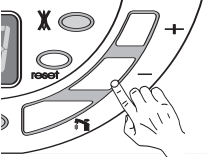
ACTION	CONFIGURATION	DISPLAY														
	Menu - 3 - Boiler options	-3-	Factory setting													
once		<table border="1"> <thead> <tr> <th>Section</th> <th>Digit 1</th> <th>Digits 2 and 3</th> </tr> </thead> <tbody> <tr> <td rowspan="2">Under floor heating system</td> <td rowspan="2">0</td> <td>0 : no</td> </tr> <tr> <td>1 : yes</td> </tr> <tr> <td>DHW Delay (time before CH relights after a DHW cycle)</td> <td>5</td> <td>0 to 5 mn by step 0.5mn</td> </tr> <tr> <td>DHW flow swith Delay (time before DHW flow detection to override pressure peak problem)</td> <td>6</td> <td>0 to 20 1/10 seconds</td> </tr> </tbody> </table>	Section	Digit 1	Digits 2 and 3	Under floor heating system	0	0 : no	1 : yes	DHW Delay (time before CH relights after a DHW cycle)	5	0 to 5 mn by step 0.5mn	DHW flow swith Delay (time before DHW flow detection to override pressure peak problem)	6	0 to 20 1/10 seconds	 ✓  ✓  ✓  ✓
Section		Digit 1	Digits 2 and 3													
Under floor heating system		0	0 : no													
			1 : yes													
DHW Delay (time before CH relights after a DHW cycle)	5	0 to 5 mn by step 0.5mn														
DHW flow swith Delay (time before DHW flow detection to override pressure peak problem)	6	0 to 20 1/10 seconds														
																
x times																

ACTION	CONFIGURATION	DISPLAY																																				
	Menu - 4 - Boiler settings	-4-	Factory setting																																			
once		<table border="1"> <thead> <tr> <th>Section</th> <th>Digit 1</th> <th>Digits 2 and 3</th> </tr> </thead> <tbody> <tr> <td rowspan="2">Room thermostat operation</td> <td rowspan="2">0</td> <td>0 : Burner only</td> </tr> <tr> <td>1 : Burner and pump</td> </tr> <tr> <td rowspan="2">Pump speed</td> <td rowspan="2">1</td> <td>0 : High speed</td> </tr> <tr> <td>1 : Low speed</td> </tr> <tr> <td rowspan="4">Pump post circulation duration From 0 to 5 minutes by step of 0.5 min.</td> <td rowspan="4">2</td> <td>0.0 min</td> </tr> <tr> <td>0.5 min</td> </tr> <tr> <td>1.0 min</td> </tr> <tr> <td>5.0 min</td> </tr> <tr> <td rowspan="2">Maximum Central Heating flow temperature</td> <td rowspan="2">4</td> <td>50°C</td> </tr> <tr> <td>80°C</td> </tr> <tr> <td rowspan="4">CH anti cycling delay From 0 to 7 minutes by step of 0.5 min.</td> <td rowspan="4">8</td> <td>0.0 min</td> </tr> <tr> <td>0.5 min</td> </tr> <tr> <td>2.5 min</td> </tr> <tr> <td>5.0 min</td> </tr> <tr> <td rowspan="2">CH maximum output limitation Model 24 From step 0 (P. min.) 8 kW to step 10 (P. max.) 24 kW</td> <td rowspan="2">9</td> <td>Value from 0 to 10</td> </tr> <tr> <td>906</td> </tr> <tr> <td rowspan="2">Model 30 From step 0 (P. min.) 9 kW to step 10 (P. max.) 28 kW</td> <td rowspan="2">9</td> <td>Value from 0 to 10</td> </tr> <tr> <td>906</td> </tr> </tbody> </table>	Section	Digit 1	Digits 2 and 3	Room thermostat operation	0	0 : Burner only	1 : Burner and pump	Pump speed	1	0 : High speed	1 : Low speed	Pump post circulation duration From 0 to 5 minutes by step of 0.5 min.	2	0.0 min	0.5 min	1.0 min	5.0 min	Maximum Central Heating flow temperature	4	50°C	80°C	CH anti cycling delay From 0 to 7 minutes by step of 0.5 min.	8	0.0 min	0.5 min	2.5 min	5.0 min	CH maximum output limitation Model 24 From step 0 (P. min.) 8 kW to step 10 (P. max.) 24 kW	9	Value from 0 to 10	906	Model 30 From step 0 (P. min.) 9 kW to step 10 (P. max.) 28 kW	9	Value from 0 to 10	906	 ✓  ✓  ✓  ✓  ✓  ✓  ✓  ✓  ✓  ✓  ✓  ✓  ✓  ✓  ✓  ✓
Section		Digit 1	Digits 2 and 3																																			
Room thermostat operation		0	0 : Burner only																																			
			1 : Burner and pump																																			
Pump speed		1	0 : High speed																																			
			1 : Low speed																																			
Pump post circulation duration From 0 to 5 minutes by step of 0.5 min.		2	0.0 min																																			
			0.5 min																																			
			1.0 min																																			
			5.0 min																																			
Maximum Central Heating flow temperature		4	50°C																																			
			80°C																																			
CH anti cycling delay From 0 to 7 minutes by step of 0.5 min.		8	0.0 min																																			
			0.5 min																																			
			2.5 min																																			
			5.0 min																																			
CH maximum output limitation Model 24 From step 0 (P. min.) 8 kW to step 10 (P. max.) 24 kW		9	Value from 0 to 10																																			
			906																																			
Model 30 From step 0 (P. min.) 9 kW to step 10 (P. max.) 28 kW		9	Value from 0 to 10																																			
	906																																					
																																						
x times																																						

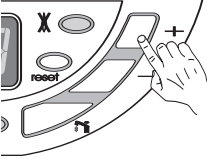
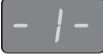
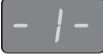
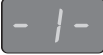
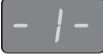
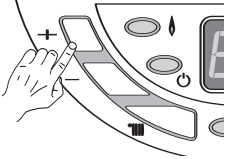
ACTION	CONFIGURATION	DISPLAY				
	Menu - 5 - Combustion rate control mode					
press once		<table border="1"> <thead> <tr> <th data-bbox="624 367 699 394">Effect</th> <th data-bbox="1059 367 1155 394">Display</th> </tr> </thead> <tbody> <tr> <td data-bbox="440 427 858 454">Combustion rate control mode OFF</td> <td data-bbox="1390 421 1493 474">  </td> </tr> </tbody> </table>	Effect	Display	Combustion rate control mode OFF	
Effect	Display					
Combustion rate control mode OFF						
wait 5 "	<table border="1"> <tbody> <tr> <td data-bbox="440 622 836 752">Switching on the combustion rate control mode. Central heating output reach the maximum power set in menu 4 section 9.</td> <td data-bbox="887 622 1278 786">Central heating temperature is displayed in celsius degrees. The 3 dots indicate that the combustion rate control is ON at maximum output.</td> <td data-bbox="1390 663 1493 716">  </td> </tr> </tbody> </table>	Switching on the combustion rate control mode. Central heating output reach the maximum power set in menu 4 section 9.	Central heating temperature is displayed in celsius degrees. The 3 dots indicate that the combustion rate control is ON at maximum output.			
Switching on the combustion rate control mode. Central heating output reach the maximum power set in menu 4 section 9.	Central heating temperature is displayed in celsius degrees. The 3 dots indicate that the combustion rate control is ON at maximum output.					
	press once	<table border="1"> <tbody> <tr> <td data-bbox="440 896 799 954">Switching the combustion rate down to minimum power.</td> <td data-bbox="887 896 1278 1059">Central heating temperature is displayed in celsius degrees. The dot indicates that the combustion rate control is ON at minimum output.</td> <td data-bbox="1390 936 1493 990">  </td> </tr> </tbody> </table>	Switching the combustion rate down to minimum power.	Central heating temperature is displayed in celsius degrees. The dot indicates that the combustion rate control is ON at minimum output.		
Switching the combustion rate down to minimum power.	Central heating temperature is displayed in celsius degrees. The dot indicates that the combustion rate control is ON at minimum output.					
	press once	<table border="1"> <tbody> <tr> <td data-bbox="440 1164 863 1256">Switching on the combustion rate to maximum output set in menu 4 section 9.</td> <td data-bbox="887 1164 1278 1328">Central heating temperature is displayed in celsius degrees. The 3 dots indicate that the combustion rate control is ON at maximum output.</td> <td data-bbox="1390 1205 1493 1258">  </td> </tr> </tbody> </table>	Switching on the combustion rate to maximum output set in menu 4 section 9.	Central heating temperature is displayed in celsius degrees. The 3 dots indicate that the combustion rate control is ON at maximum output.		
Switching on the combustion rate to maximum output set in menu 4 section 9.	Central heating temperature is displayed in celsius degrees. The 3 dots indicate that the combustion rate control is ON at maximum output.					
	press once	<table border="1"> <tbody> <tr> <td data-bbox="440 1489 836 1547">Switching off the combustion rate control mode.</td> <td data-bbox="1390 1482 1493 1536">  </td> </tr> </tbody> </table>	Switching off the combustion rate control mode.			
Switching off the combustion rate control mode.						
	press once					

Locking conditions of the combustion rate control mode :

- boiler in stand by mode
- D.H.W. draw off
- room thermostat is not calling for heat
- room thermostat is calling for heat but the maximum temperature is reached
- boiler in lockout mode
- after a reset or if the main supply fails
- end of the mode if the operator leaves menu 5
- after 15 minutes if there is no keys are pressed

Note : As soon as the combustion rate control mode is on, the Central Heating and Domestic Hot Water keys become inactive.

CH heat output setting :

If you would like to change the setting of the C.H. heat output, please proceed as follows :



(Note: the factory setting is 18 kW and the following explanation refer to menu 4 section 9)

1 - Switch to the installer mode, press both the **+** and **-** keys on the DHW side for 5 seconds.
The display shows :
-1- then **0.-** if there is no default in the default register.

2 - press the menu key 3 times **+** (on CH side) to gain access to menu **-4-**,
The display shows :
-4- then the value set for section 0 (**00** or **01** respectively Action on burner only or pump and burner)

3 - change to Section 9 (Adjustment of C.H. heat output). Press the **+** key on the DHW side times.
The display shows :
(906 which corresponds to 18 kW which is the factory setting)
9 = section 9 **06** = 18 kW

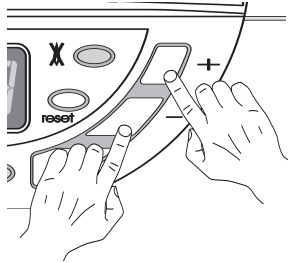
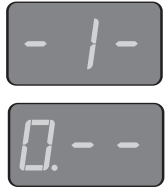
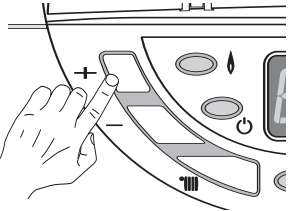
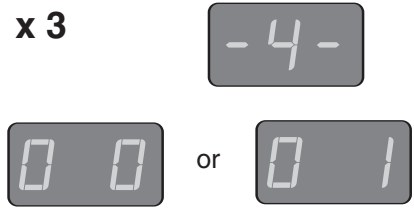
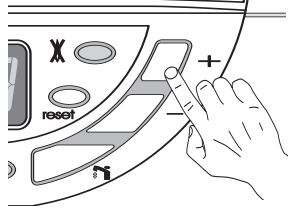
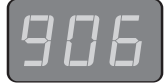
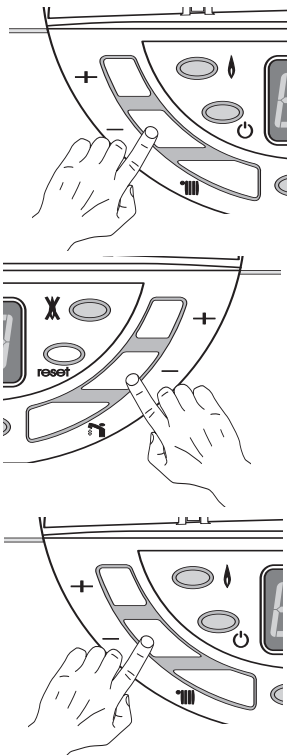
4 - press the setting key **-** (on CH side) once, the 2nd and 3rd digits flash together. Then press the **-** or **+** key on the DHW side to change the C.H. heat output step between **00** and **10**.
Press the setting key to confirm the value. The display stops flashing. The setting procedure is finished.
To exit from the setting mode, leave the boiler for approx. 1 minute, the boiler will then revert to the user mode.
After programming please close the door **P** (Fig. 18)

		Display
1	 <p style="text-align: right;">5''</p>	
2	 <p style="text-align: right;">x 3</p>	
3	 <p style="text-align: right;">x 9</p>	
4		

10

Incorrect Function

In case of problem, or when the boiler has to display a message, the display flashes 2 digits. Please refer to the table below to diagnose the default.

For default 01 and 03, the red indicator 38 will light (Fig.19)

Overheat lock out

FAULT **-01**

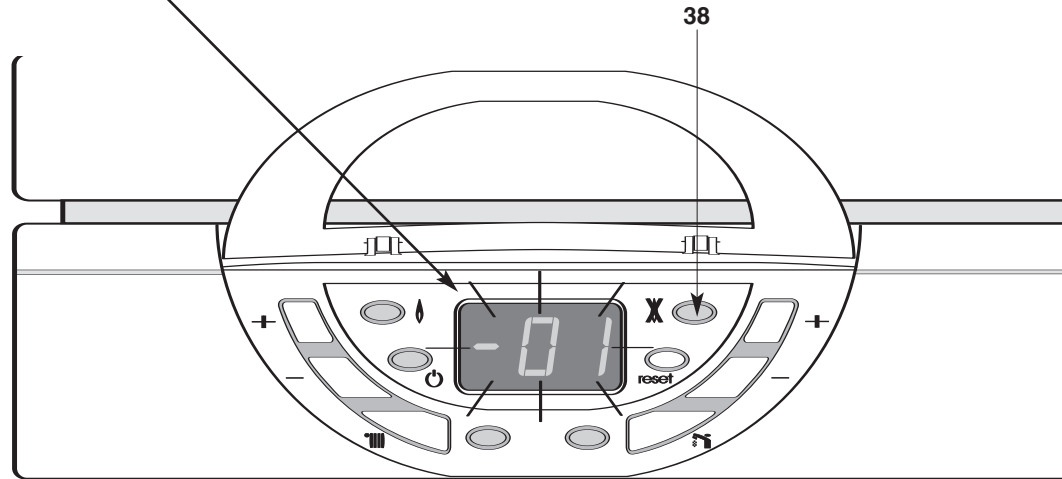

Fig. 19

Code display	Fault description	Information on functioning
01	Overheat lock out	
03	No flame detection	
05		Anti freezing system, pump on
06		Anti freezing system, pump and burner on
07	No water circulation in primary circuit	
08	No water in the primary circuit	
09	Domestic Hot Water thermistor faulty (open circuit)	
10	Domestic Hot Water thermistor faulty (short circuit)	
11	Central Heating thermistor faulty (open circuit)	
12	Central Heating thermistor faulty (open circuit)	
18		Attempt to re ignite
20	Wiring problem	
23	Fan speed too low	
24	Fan control system defective	
25	Thermistor cylinder open	
26	Thermistor cylinder bypassed	
29	Three way valve blocked in CH mode	
31	Communication problem with the display PCB	
32	Communication problem with the main PCB	

11

Gas Conversion

If the boiler is not set for the required gas type, conversion kits are available. To convert the boiler, please use only Chaffoteaux & Maury parts and proceed as is mentioned in the instructions provided with the conversion kit.

USER'S INSTRUCTIONS

12

Control Panel

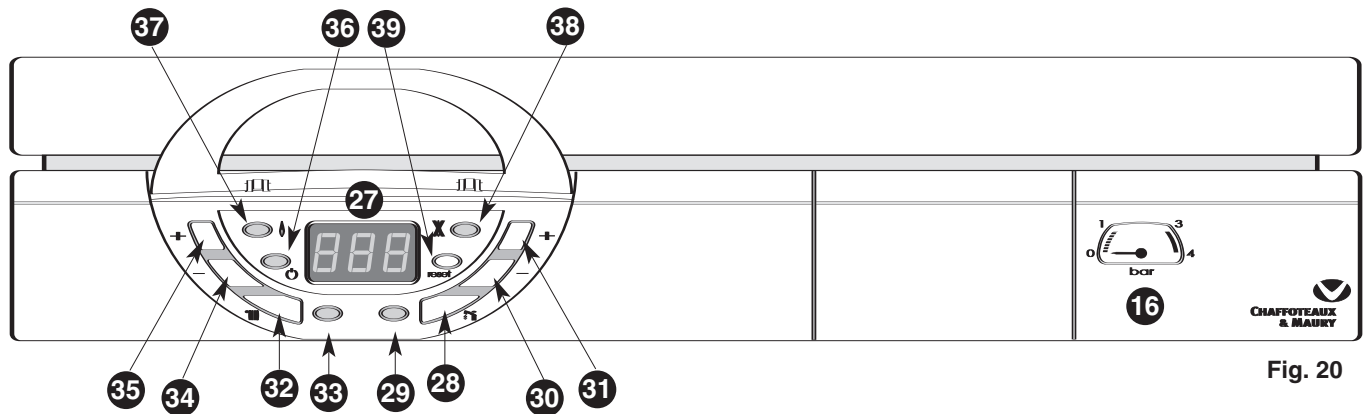

Fig. 20

Control panel (fig. 20)

- 16.- Pressure gauge
- 27.- Display
- 28.- Switch for Domestic Hot Water mode
- 29.- Green indicator Heating / Domestic Hot Water mode ON
- 30.- Key to reduce the Domestic Hot Water temperature
- 31.- Key to rise up the Domestic Hot Water temperature
- 32.- Switch for Central Heating (Winter) mode
- 33.- Green indicator Central Heating mode ON **RESET** Reset button
- 34.- Key to decrease the Central Heating temperature
- 35.- Key to increase the Central Heating temperature
- 36.- Green indicator - Power ON
- 37.- Orange indicator - Burner ON
- 38.- Red indicator - Lock out / flame failure
- 39.- **Reset** button

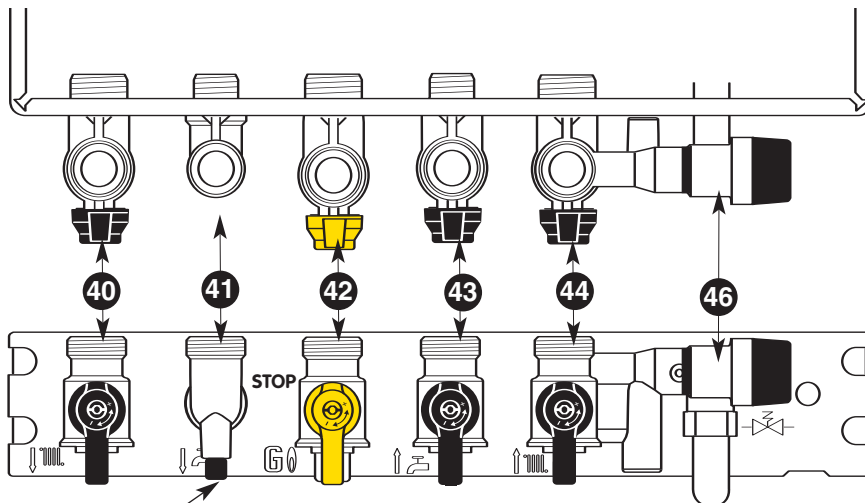



Fig. 21

Connecting bracket

Taps shown in Open position (Fig. 21)

- 40 : Central Heating flow isolating valve
- 41 : Domestic Hot Water outlet
- 42 : Gas service tap
- 43 : Water service tap
- 44 : Central Heating return isolating valve
- 46 : Central Heating pressure relief valve
- 48 : D.H.W. drain screw



Switching on



1. Check that pressure in central heating system is above 0.7 bar and below 1.5 bar with the pressure gauge 16.
2. Check that the gas service tap is opened at the gasmeter and main power is on. Green indicator  Power ON 36.
3. Open the gas tap 42 (Fig.21).

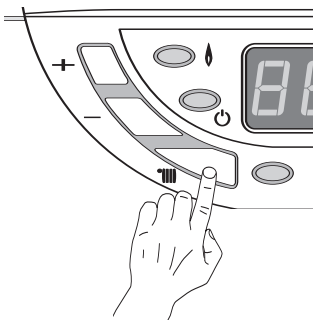

The boiler is now ready to use.

Attention ! If the boiler stays a long time without working, some air in the gas pipe can hinder the first lightings. (please refer to **Section 18 Incorrect Function**).

Switching on the Central Heating

Press on key 32 , the green indicator 33 will light and the display will show the Heating flow temperature. 

Keys 34  and 35  allow the adjustment of the temperature required in the Central Heating system dependent on the weather conditions.

- press  to increase the temperature when the weather is cold
- press  to decrease the temperature when the weather is fair

During the temperature setting operation the display will flash.

If the room thermostat is calling for heat, a dot will be displayed at the bottom of the 3rd digit

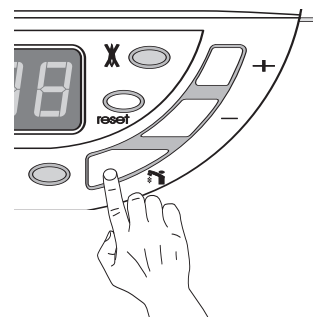
**Switching on the Domestic Hot Water**



Press key 28 , the green indicator 29 will light :

If there is no water demand

the display will show the following graphic 

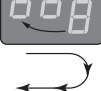
In case of draw off

a square made of 4 digits will move clockwise on the display 

Keys 30  and 31  allow the adjustment of the temperature required for the Domestic Hot Water flow. During the temperature setting operation the display will flash.

Note : The configuration of the C.H. system can generate some gravity effect when the boiler is set in DHW mode only. It may result in a temperature rise of the heating pipes close to the boiler (or eventually a radiator). To avoid this it is possible during the summer period (Central Heating switched off) To close the Central Heating flow isolating tap (40 Fig. 21). Don't forget to open it before switching on the Central Heating mode again.

Switching on the Domestic Hot water and Central Heating together

Press key 32  the green indicator 33 will light.

Press key 28  the green indicator 29 will light.

If there is no water demand the display will show the heating flow temperature 

In case of draw off a square made of 4 digits will move clockwise on the display 

13

How to Use (continued)

Stand by mode



A fixed digit at the centre of the display and the green indicator 36 on

Putting the boiler in stand by mode and anti freeze system. :

Press key 32 and 28 , to switch off both DHW and C.H. mode. The green indicators 39 and 29 will stop.

During the duration of the stand-by mode, an automatic anti-sticking system will switch on the pump for 1 minute and activate the 3 way valve every 23 hours.

The stand-by mode will disable the anti-freeze function of the room thermostat (if fitted). To leave the room thermostat anti-freeze system operative, please leave the Central Heating mode on.

The boiler is equipped with an automatic anti-freeze system which is permanently on.

If the Central Heating temperature falls below 7°C, the pump will start.

If the Central Heating temperature falls below 4°C, the pump and the burner will start.

Turn off the boiler

- Press on key 32 and 28 , to switch off both DHW and CH mode. The green indicators 33 and 29 will go out
- Switch off the main electrical supply
- Shut off the gas service tap 42 (Fig. 21)

Note : In this condition, the **anti-freeze** system is inoperative.

14

Maintenance

As with your car, your boiler will work more reliably and efficiently if regularly serviced. We recommend an annual service check. The service history of the appliance will be marked on the Log Book.

15

Guarantee

The manufacturer`s guarantee is for 12 months from the date of purchase. The guarantee is voidable if the appliance is not installed in accordance with the recommendations made herein or in a manner not approved by the manufacturer. To assist us in providing you with an efficient after sales service, please return the guarantee registration card enclosed with the boiler without delay.

16

Practical Information

Pump anti-sticking device

When the boiler is switched on, an automatic anti-sticking system will switch on the pump for 1 minute and make a movement of the 3 way valve every 23 hours. This is a normal function.

Precaution to avoid freezing

We recommend you contact your installer or local service centre to take precautions adapted to your system.

• DHW system

Turn off the main cold water supply and drain the boiler :

- Open a hot water tap
- Unscrew the cold water inlet tail
- Drain the water out the boiler with the drain valve 48 (Fig. 21)

• C.H. system

Chose one of the following solutions :

- 1) Drain the Central Heating system completely
- 2) Protect the Central Heating system with anti-freeze chemical products and verify periodically the concentration
- 3) Leave the Heating mode switched on and set the room thermostat to anti-freeze mode (between 5 and 10°C)
- 4) Leave your boiler in stand-by mode, the anti-freeze device will switch on the pump and the burner if necessary.

17

Gas Conversion

This appliance is suitable for Natural Gas or L.P.G. A gas conversion must be made by a competent person.

18

Incorrect Function

Fault	Cause	Solution
The boiler doesn't start	No gas, no water or no electricity	Control gas, water and electrical supply, fuses...
	Air in the gas pipe	Follow the procedure in Section 8
		Set up the room thermostat
Red indicator lit	Room thermostat switched off	Wait for a few minutes Press the reset button 39 (Fig.21) the red led will go out and the boiler will attempt to re-light. If red the indicator lights too frequently, please call your local service centre.
Noises in CH system	Air presence in C.H. system or. Insufficient pressure	Purge the system of air and increase the system pressure (Section 8)
Radiators rise in temperature during summer season	Gravity effect in the C.H. system	Close the Central Heating flow isolating valve 37 . Don't forget to open it again before starting the heating.

If these solutions do not cure the fault, call a qualified professional

Model	Calydra green 24		Calydra green 30	
Appliance category.....	II 2H3P		II 2H3P	
Heat gross input C/H maxi	27.8 kW	94534 Btu/h	31.6 kW	107843 Btu/h
Heat gross input DHW maxi.....	27.8 kW	94534 Btu/h	31.6 kW	107843 Btu/h
Heat output C/H 50°/30° maxi	26 kW	88732 Btu/h	30 kW	102383 Btu/h
Heat output C/H 80°/60° maxi.....	24 kW	81907 Btu/h	28 kW	95557 Btu/h
Heat output DHW maxi	24 kW	81907 Btu/h	30 kW	102383 Btu/h
C/H operating temperature.....	80°C max	25°C min	80°C max	25°C min
C/H circuit pressures Min operating	0.7 bar	10 lb/in ²	0.7 bar	10 lb/in ²
C/H circuit pressures Max operating	2.5 bar	36.3 lb/in ²	2.5 bar	36.3 lb/in ²
DHW flow rates 30°C	12.5 l/min	2.77 gal/min	14.5 l	3.21 gal/min
DHW flow rates 35°C	10.7 l/min	2.38 gal/min	12.4 l	2.76 gal/min
Cold water mains pressures Min operating.....	0.5 bar	7.25 lb/in ²	0.5 bar	7.25 lb/in ²
Cold water mains pressures Max operating.....	10 bar	145 lb/in ²	10 bar	145 lb/in ²
Flow limiter rate.....	8 l/min		10 l/min	
Compartment ventilation	not required		not required	
Natural gas G20				
Gas rate C/H max	2.64 m ³ /h	93 ft ³ /h	3,01 m ³ /h	106 ft ³ /h
Gas rate DHW max	2.64 m ³ /h	93 ft ³ /h	3,01 m ³ /h	106 ft ³ /h
Gas rate C/H & DHW mini.....	0.87 m ³ /h	31 ft ³ /h	1 m ³ /h	35 ft ³ /h
Gas valve restrictor diameter	without		without	
Propane L.P.G G31				
Gas rate C/H max.	1.94 kg/h	36 ft ³ /h	2.21 kg/h	41 ft ³ /h
Gas rate DHW max.	1.94 kg/h	36 ft ³ /h	2.21 kg/h	41 ft ³ /h
Gas rate C/H & DHW mini.....	0.64 kg/h	12 ft ³ /h	0.73 kg/h	13 ft ³ /h
Gas valve restrictor diameter	4.40 mm		4.8 mm	
Safety discharge	3 bar	43.5 lb/in ²	3 bar	43.5 lb/in ²
Expansion vessel - Pre-charge pressure	0.7 bar	9.4lb/in ²	0.7 bar	9.4lb/in ²
Net capacity at 3 bar in liter.....	5.44		5.44	
Adjustable by-pass				
Electrical characteristics				
Supply	230 v		230 v	
Consumption.....	150 w		150 w	
Protection	IP 44		IP 44	
Fuse F1	2 A		2 A	
Fuse F2.....	1.25 A		1.25 A	
Fuse F3.....	0.315 A		0.315 A	
Fuse F4	0.250 A		0.250 A	
External controls	24 v		24 v	

This appliance is suitable for Natural gas or LPG. A gas conversion must be made by a competent person.
Chaffoteaux & Maury are continuously improving their products and therefore reserve the right to change specifications without prior notice and accepts no liability for any errors or omission in the information contained in this document.

Manufacturer: **Chaffoteaux & Maury - France**

Commercial subsidiary: **MTS (GB) Limited**
MTS Building
Hughenden Avenue
High Wycombe
Bucks HP13 5FT

Telephone: (01494) 755600
Fax: (01494) 459775
Internet: www.chaffoteaux.co.uk
E-mail: info@uk.mtsgroup.com

Technical Support Help Line: 0870 241 8180
Customer Service Help Desk: 0870 600 9888