



Gas 310/610 Eco

Condensing Boilers



High-efficiency fully modulating condensing boiler with ultra low NOx emission

OUTPUTS

Gas 310 ECO		Gas 610 ECO	
-5	51-261kW		
-6	65-327kW	-6	130-654kW
-7	79-395kW	-7	158-790kW
-8	92-462kW	-8	184-924kW
-9	106-531kW	-9	212-1062kW



Introduction

The Remeha Gas 310 ECO and the Remeha Gas 610 ECO are compact floor standing condensing boilers. Their small footprint and ability to be installed side to side makes them ideally suited for modular configuration. An optional Optimising Weather Compensating control package is available to ensure maximum efficiency. The boilers are suitable for both new and retro-fit applications. With conventional and room sealed capability they can be installed in most situations.

Contents

	page
Introduction	2
Boiler description	2
Advantages at a glance	3
Application information	3
Typical boiler construction	4-5
Efficiency information	4-5
Operating principle	6-7
Dimensions/technical data	8-11
Maintenance areas	12-13
Flue data	14-17
Electrical connections and controls	18-23

Boiler description

The Remeha Gas 310/610 ECO boilers are fully assembled, free standing, gas fired (Natural gas only), fully modulating high efficiency condensing boilers and are supplied on wheels for easy manoeuvrability into the boiler house.

The sectional cast aluminium heat exchanger and other major components are contained within a rigid steel frame with removable casing parts for maintenance purposes. The Remeha Gas 310 ECO and each Remeha Gas 610 ECO module frame is fitted with a set of wheels to enable the assembled unit to be easily manoeuvred into position within the plant room on site with the minimum of effort. All major electrical and electronic controls are contained within the instrument panel mounted on top of the boiler at the opposite end to the connections facing to the front (long side) but can be rotated 90° towards the short side to suit site location. The Remeha Gas 310 ECO boiler is available with flow and return connections on the left or right hand end of the boiler (THIS MUST BE DECIDED AT TIME OF ORDER), with the gas connection on the top of the boiler. The flue gas outlet complete with a condensate connection is at low level on the same end as the F/R connections. The combustion air inlet (for room sealed operation) is located at the top of the boiler. The Remeha Gas 610 ECO boiler has two flows and returns at one end of the boiler with a combined flue gas outlet.

The boilers are suitable for room sealed or conventional flue applications and have been designed for central heating and indirect hot water production at working pressures not exceeding 6 bar. They must be installed on a fully pumped system and are designed for operating pressures between 0.8 and 6 bar.

The pre-mix gas burner (NG only) with its gas/air ratio control system ensures clean, trouble free operation with higher than average efficiencies of up to 109% Hi (NCV) in the condensing mode combined with ultra low NOx and minimum CO emissions.

The standard control package allows for external On/Off, High Low (volt free switch/s) or Modulating control (0-10V input). The built in digital display shows normal operating / fault code indication and allows actual and set values to be read and adjusted.

The intelligent, advanced boiler control ('abc®') continuously monitors the boiler operating conditions, varying the heat output to suit the system load. The control is able to react to external "negative" influences in the rest of the system (flow rates, air / gas supply problems) maintaining boiler output for as long as possible without resorting to a lock out condition. At worst the boiler will reduce its output and/or shut down (shut off mode) awaiting the "negative" conditions to return to normal before re-starting. The 'abc®' control cannot override the standard flame safety controls.

All Remeha Gas 310/610 ECO boilers are live fired after assembly to ensure the boiler and controls comply to our strict quality policy.

Advantages at a glance

Application information

The Remeha Gas 310/610 ECO boilers can be used on all new and refurbishment projects in both single and multiple configurations. Conventional and room sealed flue system capability means that the boiler can be sited almost anywhere within a building.

The Remeha Rematic® and "OpenTherm" weather compensators (option) are able to communicate directly with the boilers controls to make full use of their fully modulating features, ensuring that the boiler closely matches the system demand at all times.

External control systems (BMS) can be interfaced with the boiler to provide on/off - high/low or modulating (0-10V) control options.



- Inspected for compliance
- Compact lightweight construction
- Supplied with wheels for quick and easy installation
- High efficiency - 108.9% at 50°C/30°C (97%GVC)
- Boiler controls - on/off high/low or fully modulating over 20%-100%
- Low NOx 25 ppm at O2 = 0%
- Ultra quiet > 60 dBA
- Digital Diagnostic Display
- Cast - sectional aluminium heat exchanger
- Cylindrical, stainless steel, premix burner
- Control adjustable 20°C-90°C
- Air pressure differential sensor (LDS)
- Temperature sensors for low water level protection
- Gas/air mixing system with venturi
- Electronic control and protection equipment
- Frost protection
- Conventional or room sealed capability
- Menu controlled microprocessor boiler control
- Enhanced failure functionality

The unit has been inspected for compliance with the essential requirements of the following directives:

- Gas Appliances Directive, no. 90/396/EEC
- Efficiency Directive, no. 92/42/EEC
- EMC Directive, no. 89/336/EEC
- Electrical Low Voltage Directive, no. 73/23/EEC
- Pressure Equipment Directive, no. 97/23/EEC, art. 3, item 3

CE identification number (PIN) : 0063BP3474

NOX Class : 5

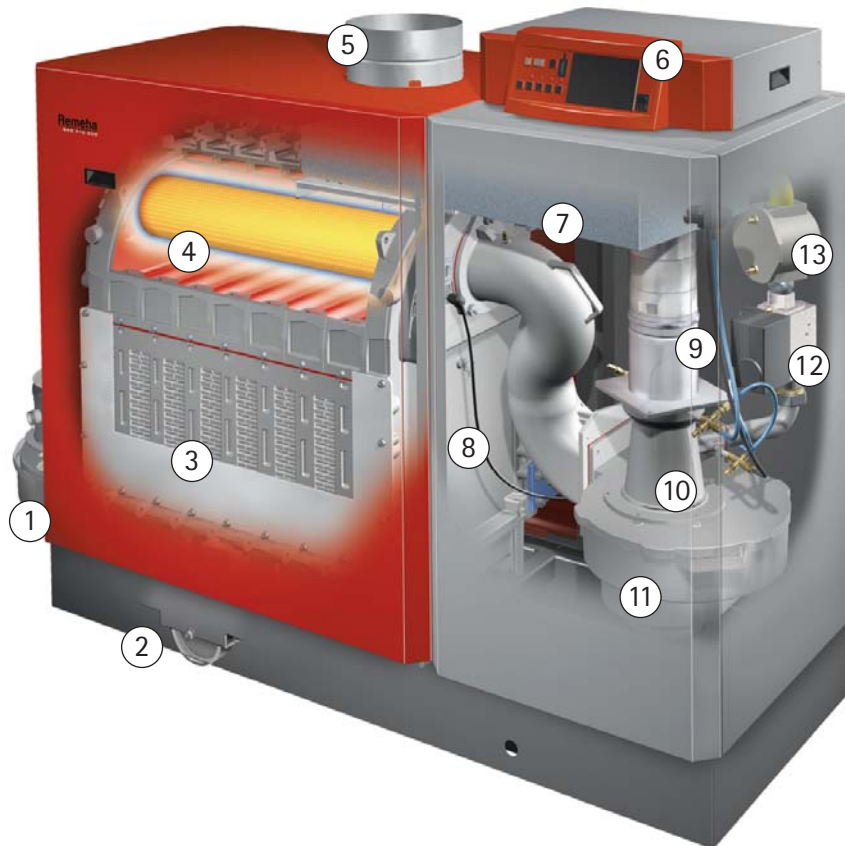

Typical Remeha Gas 310 ECO boiler construction

- | | |
|-------------------------|------------------------------------|
| 1. condensate collector | 8. boiler block temperature sensor |
| 2. wheel | 9. non return valve |
| 3. inspection hatch | 10. venturi |
| 4. heat exchanger | 11. fan |
| 5. air supply | 12. gas multiblock |
| 6. instrument panel | 13. gas filter |
| 7. air box | |

Efficiency information

Annual Efficiency

Up to 108.9% at Hi (up to 97% at Hs) at an average water temperature of 40°C (50°C/30°C).

Heat to water efficiency

a. Up to 98.5% at Hi (88% at Hs) at an average water temperature of 70°C (80°C/60°C).

b. Up to 106.4% at Hi (98% at Hs) at an average water temperature of 40°C (50°C/30°C).

Standing losses

Less than 0.3% at Hi (0.33% at Hs) at an average water temperature of 45°C

Note: NCV = Hi, GCV = Hs

The unit has been inspected for compliance with the essential requirements of the following directives:

- Gas Appliances Directive, no. 90/396/EEC
- Efficiency Directive, no. 92/42/EEC
- EMC Directive, no. 89/336/EEC
- Electrical Low Voltage Directive, no. 73/23/EEC
- Pressure Equipment Directive, no. 97/23/EEC, art. 3, item 3

CE identification number (PIN) : 0063BP3474

NOX Class : 5



Typical Remeha Gas 610 ECO boiler construction

- | | | | |
|----|--------------------------|-----|-------------------------------------|
| 1. | 2 x condensate collector | 8. | 2 x boiler block temperature sensor |
| 2. | 2 x wheel | 9. | 2 x non return valve |
| 3. | 2 x inspection hatch | 10. | 2 x venturi |
| 4. | 2 x heat exchanger | 11. | 2 x fan |
| 5. | 2 x air supply | 12. | 2 x gas multiblock |
| 6. | 2 x instrument panel | 13. | 2 x gas filter |
| 7. | 2 x air box | | |

Efficiency information

Annual Efficiency

Up to 108.9% at Hi (up to 97% at Hs) at an average water temperature of 40°C (50°C/30°C).

Heat to water efficiency

a. Up to 98.5% at Hi (88% at Hs) at an average water temperature of 70°C (80°C/60°C).

b. Up to 106.4% at Hi (98% at Hs) at an average water temperature of 40°C (50°C/30°).

Standing losses

Less than 0.3% at Hi (0.33% at Hs) at an average water temperature of 45°C

Note: NCV = Hi, GCV = Hs

Operating principle

Combustion air is drawn into the inlet connection from the plant room (conventionally flued) or from outside via the eccentric flue system (room sealed) by an air supply fan.

On the inlet side of the fan is a specially designed chamber (venturi unit) which takes gas from the multiblock and mixes it in the correct proportions with the incoming air. This mixing system ensures that the correct gas / air ratio is delivered to the pre-mix burner at all times.

Depending on demand (under the dictates of flow/return sensor and other external/internal control inputs) the 'abc®' system determines the required boiler output. The 'abc®' control then varies the speed of the air supply fan

which alters the volume of air being drawn into the venturi, this change in volume is measured using air pressure differential which directly controls the volume of gas also being delivered to the venturi. The resultant controlled mixture is delivered to the premix burner.

This mixture is initially ignited by the combined ignition/ionisation probe, which monitors the state of the flame. Should the flame be unstable or not ignite within the pre-set safety time cycle the controls will (after 5 attempts) shut the boiler down requiring manual intervention to reset the boiler. The digital display will indicate a flashing fault code confirming the reason for the failure.

The products of combustion in the form of hot flue gases are forced through the heat



exchanger transferring their heat to the system water (the flue gas temperature is reduced to approximately 5°C/8°C above the temperature of the system return water) then discharged via the condensate collector, to the flue gas outlet connection, to the atmosphere.

There will be a vapour cloud formed at the flue gas terminal, because of the low flue gas exit temperature - this is not smoke, simply water vapour formed during the combustion process.

When the flue gas temperature falls below dew point (55°C), water vapour (created during the combustion process) will begin to condense out in the boiler, transferring its latent heat into the system water, thereby increasing the output of the boiler without increasing the gas consumption.

Condensation formed within the boiler and flue system is discharged from the boiler to an external drain via the drain pan and siphon supplied.







The boiler can be supplied, as an option with a second (constant temperature) return connection. This additional connection enables the boiler to make full use of its condensing ability whilst accepting both fixed and variable temperature returns from the same system.

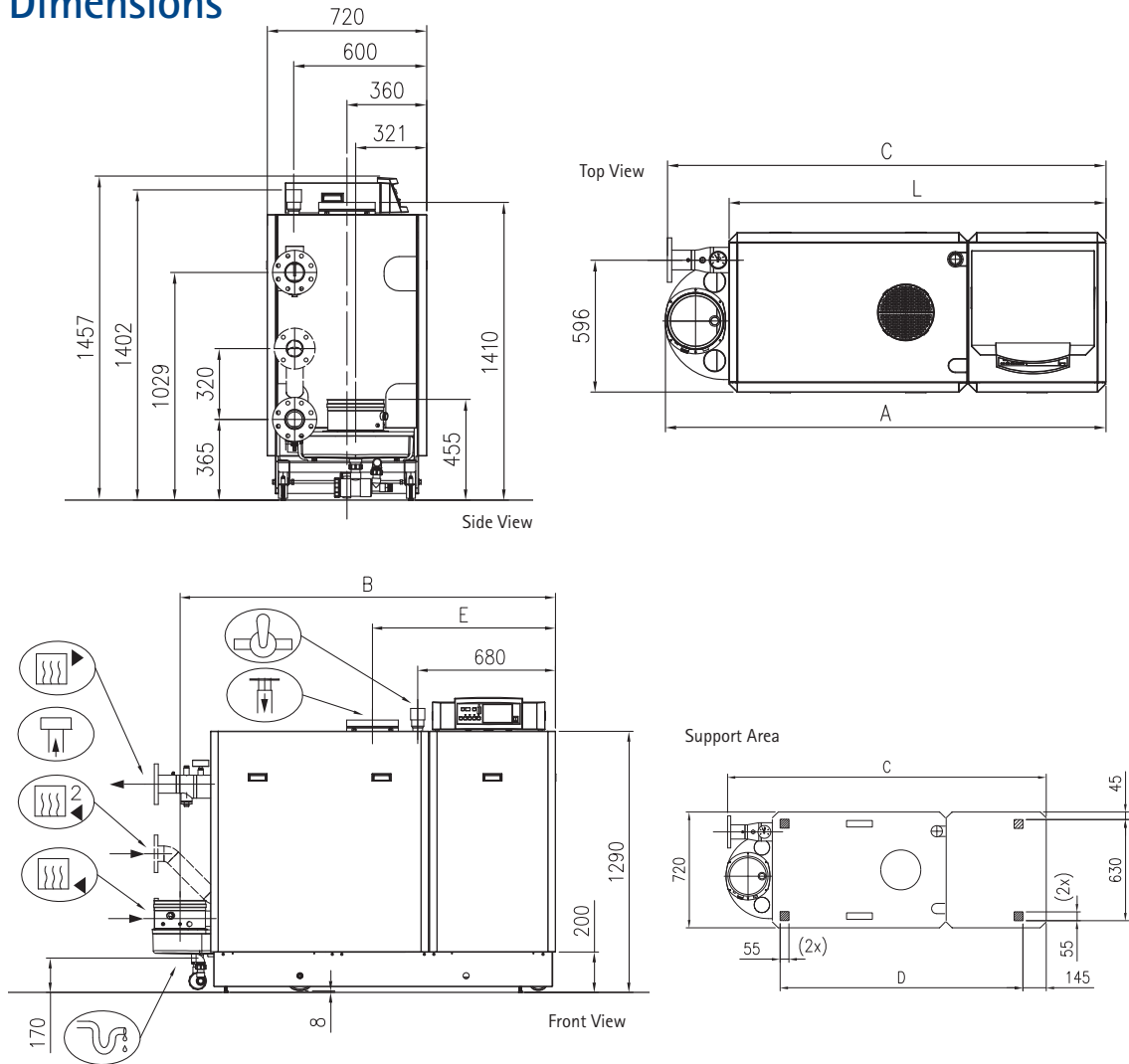

Remeha Gas 310 ECO

Dimensions



-  Flow connection NW 80, DIN 2576
-  Return connection NW 65, DIN 2576
-  Gas connection 2" BSP (F)
-  Condensate drain 1 1/4" nb plastic waste
-  Flue gas discharge 250 mm i/d
-  Combustion air supply 250 mm i/d
-  Second return connection (optional) NW 65, DIN 2576

Remeha Gas 310 ECO						
Boiler type	A	B	C	D	E	L
5 sections	1600	1463	1590	1118	1004	1312
6 sections	1600	1463	1590	1118	901	1312
7 sections	1990	1853	1980	1508	1110	1702
8 sections	1990	1853	1980	1508	1007	1702
9 sections	1990	1853	1980	1508	904	1702

The service areas are shown on page 12.

Remeha Gas 310 ECO





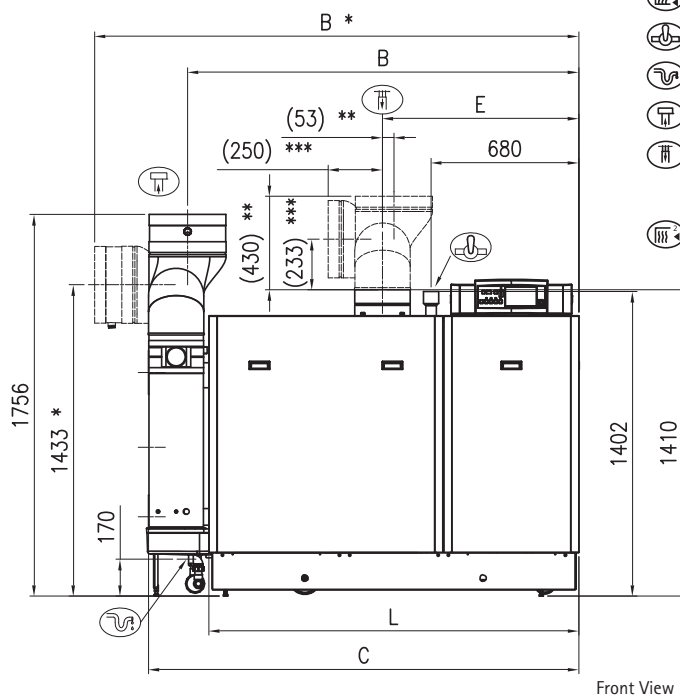
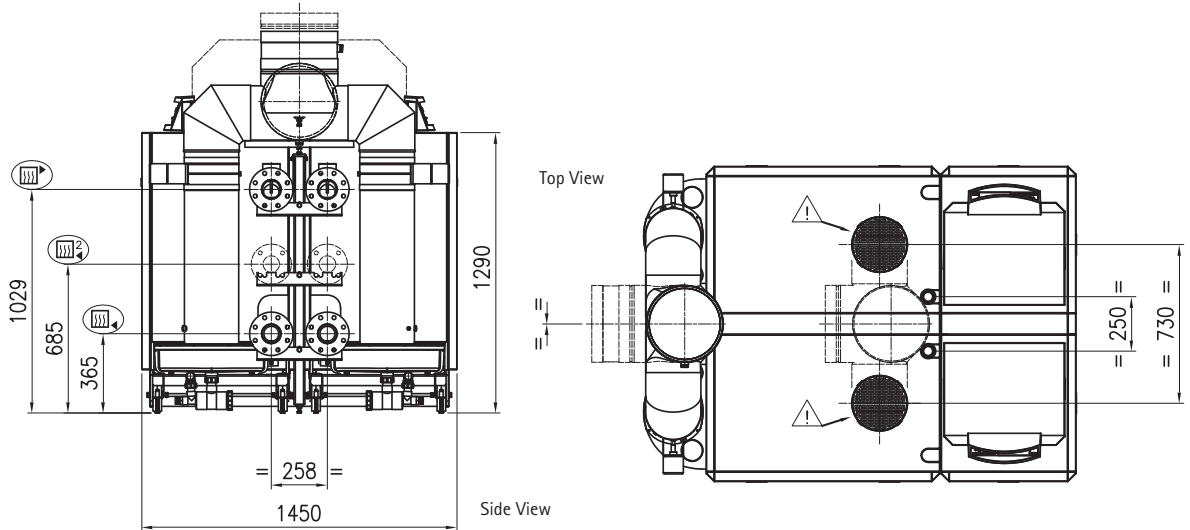

Technical data

Boiler type			Remeha Gas 310-5	Remeha Gas 310-6	Remeha Gas 310-7	Remeha Gas 310-8	Remeha Gas 310-9
General							
Boiler control options			Modulating, high/low or on/off				
Nominal output (80/60°)	min	kW	51	65	79	92	106
	max	kW	261	327	395	462	531
Nominal output (50/30°)	min	kW	56	71	84	98	113
	max	kW	282	353	427	499	573
Nominal input (GCV / Hs)	min	kW	60	75	91	105	121
	max	kW	298	372	448	523	598
Nominal input (NCV / Hi)	min	kW	54	68	82	95	109
	max	kW	269	336	404	471	539
Efficiency (Hi)							
Combustion (Hi) at 80/60°C		%	99				
Heat to water (Hi) at 80/60°C		%	98.5				
Standing losses (average temperature = 45°C)		%	< 0.3				
Annual efficiency (Hi)		%	108.9				
Gas and flue gas side							
Gas category		-	Natural gas only				
Inlet pressure gas	min	mbar	17				
	max	mbar	30	30	100	100	100
Gas consumption		m ³ /h	29	36	43	50	57
NOx emissions annual		mg/kWh	< 60				
NOv emission (annual emissions, O2 = 0%, dry)		ppm	< 35				
Residual fan duty		Pa	150	150	150	150	150
Flue gas mass	min	kg/h	91	114	138	160	183
	max	kg/h	453	565	680	793	907
Flue gas temperature at 80/60°C	min	°C	57				
	max	°C	65				
Type classification due to discharging flue gasses		-	B23, C33, C43, C53, C63, C83				
Water side							
Flow temperature	high limit	°C	110				
	operating	°C	20 - 90				
Operating pressure	min	bar	0.8				
	max	bar	6				
Water contents		litres	49	60	71	82	93
Water resistance at 11°CΔt		mbar (kPa)	374 (37.4)	364 (36.4)	397 (39.7)	364 (36.4)	413 (41.3)
Water resistance at 20°CΔt		mbar (kPa)	113 (11.3)	110 (11)	120 (12)	110 (11)	125 (12.5)
Electrical							
Mains supply		V/Hz	230/50				
Power consumption	min	VA	12	12	12	12	12
	max	VA	303	340	470	600	858
Insulation class		IP	20				
Other							
Weight dry		kg	360	410	460	510	560
Floor area		m ²	1.2	1.2	1.4	1.4	1.4
Noise level at a distance of 1 m from the boiler (average)		dB(A)	60				
Colour of casing		RAL	2002 (red); 9023 (grey)				

Remeha Gas 610 ECO

Dimensions



-  Flow connection 2 x NW 80, DIN 2576
-  Return connection 2 x NW 65, DIN 2576
-  Gas connection 2 x 2" BSP (F)
-  Condensate drain 2 x 1 1/4" nb plastic waste
-  Flue gas discharge 350 mm i/d
-  Combustion air supply 2 x 250 mm i/d (standard)
1 x 350 mm i/d (option)
-  Second return connection 2 x NW 65, DIN 2576 (optional)

- * - Alternative horizontal flue gas discharge
- ** - Alternative combined vertical air supply
- *** - Alternative combined horizontal air supply

 Room sealed operation: remove grid

Remeha Gas 610 ECO					
Boiler type	A	B	C	E	L
2 x 6 sections	1410	1463	1590	901	1312
2 x 7 sections	1800	1853	1980	1110	1702
2 x 8 sections	1800	1853	1980	1007	1702
2 x 9 sections	1800	1853	1980	904	1702

Clearance of at least 800 mm is required at the front (service side) of each boiler module. However, we recommend a clearance of 1 m. A clearance of at least 400mm above the boiler and at least 300 mm on both ends (800 mm if the instrument panel is rotated to face the short end). An isolating gas main cock must be installed near the boiler, within hand's reach.

Remeha Gas 610 ECO

Technical data

Boiler type			Remeha Gas 610-6	Remeha Gas 610-7	Remeha Gas 610-8	Remeha Gas 610-9
General						
Boiler control options			Modulating, 2-stage or 4-stage			
Nominal output (80/60°)	min	kW	87	123	122	148
	max	kW	654	790	924	1062
Nominal output (50/30°)	min	kW	94	131	130	156
	max	kW	706	854	998	1146
Nominal input (GCV / Hs)	min	kW	101	142	141	170
	max	kW	744	896	1046	1196
Nominal input (NCV / Hi)	min	kW	91	128	127	153
	max	kW	672	808	942	1078
Efficiency (Hi)						
Combustion (Hi) at 80/60°C		%	up to 99			
Heat to water (Hi) at 80/60°C		%	up to 98.5			
Standing losses (average temperature = 45°C)		%	< 0.3			
Annual efficiency (Hi)		%	108.9			
Gas and flue gas side						
Gas category		-	Natural gas only			
Inlet pressure gas	min	mbar	17			
	max	mbar	30	100	100	100
Gas consumption		m ³ /h	74	86	100	114
NOx emissions annual		mg/kWh	< 60			
NOv emission (annual emissions, O2 = 0%, dry)		ppm	< 35			
Residual fan duty		Pa	130			
Flue gas mass	min	kg/h	153	215	214	257
	max	kg/h	1130	1360	1586	1814
Flue gas temperature at 80/60°C	min	°C	57			
	max	°C	65			
Type classification due to discharging flue gasses		-	B23, C33, C43, C53, C63, C83			
Water side						
Flow temperature	high limit	°C	110			
	operating	°C	20 - 90			
Operating pressure	min	bar	0.8			
	max	bar	6			
Water contents		litres	120	142	164	186
Water resistance at 11°CΔt		mbar (kPa)	364 (36.4)	397 (39.7)	364 (36.4)	413 (41.3)
Water resistance at 20°CΔt		mbar (kPa)	110 (11)	120 (12)	110 (11)	125 (12.5)
Electrical						
Mains supply		V/Hz	230/50			
Power consumption	min	VA	24			
	max	VA	694	980	1240	1684
Insulation class		IP	20			
Other						
Weight dry		kg	820	920	1020	1120
Floor area		m ²	2.4	2.4	2.8	2.8
Noise level at a distance of 1 m from the boiler (average)		dB(A)	63			
Colour of casing		RAL	2002 (red); 9023 (grey)			

Remeha Gas 310 ECO

Maintenance areas

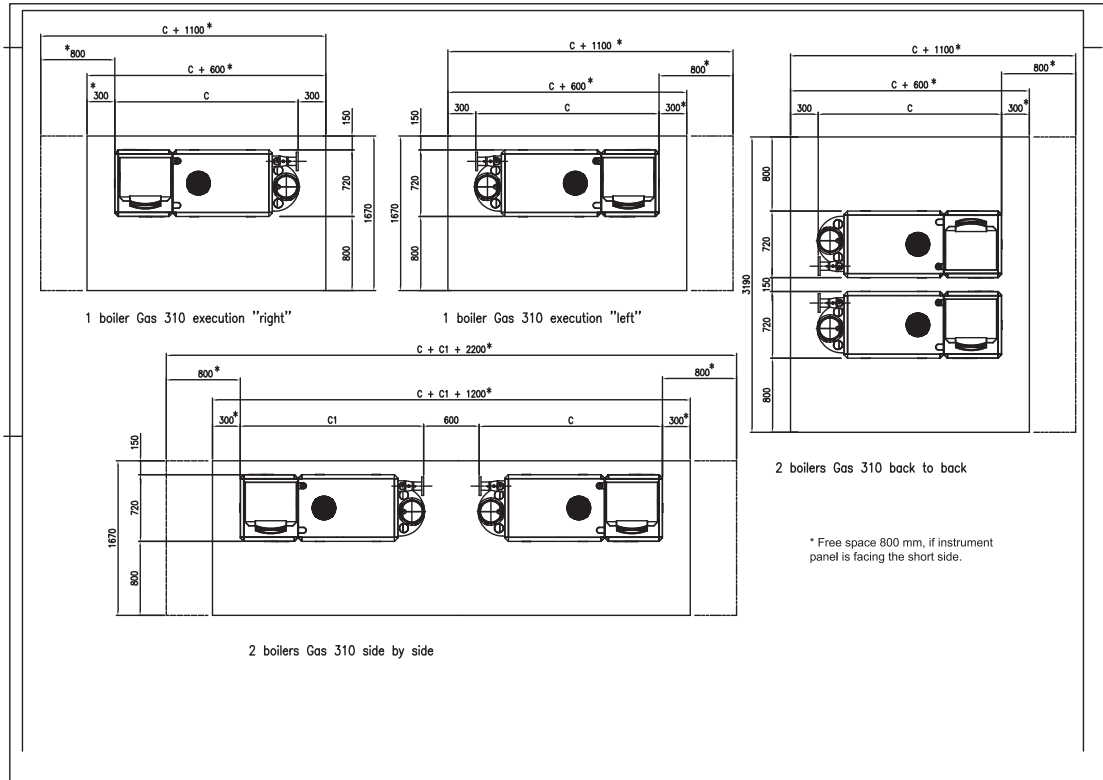

Layout in the boiler room

Number of sections	C in mm
5	1590
6	1590
7	1980
8	1980
9	1980

Clearance of at least 800 mm is required at the front (service side) of the boiler. However, we recommend a clearance of 1 m. A clearance of at least 400 mm above the boiler and at least 300 mm on both ends (800 mm if the instrument panel is rotated to face the short end). An isolating gas main cock must be installed near the boiler, within hand's reach.

Remeha Gas 610 ECO

Maintenance areas

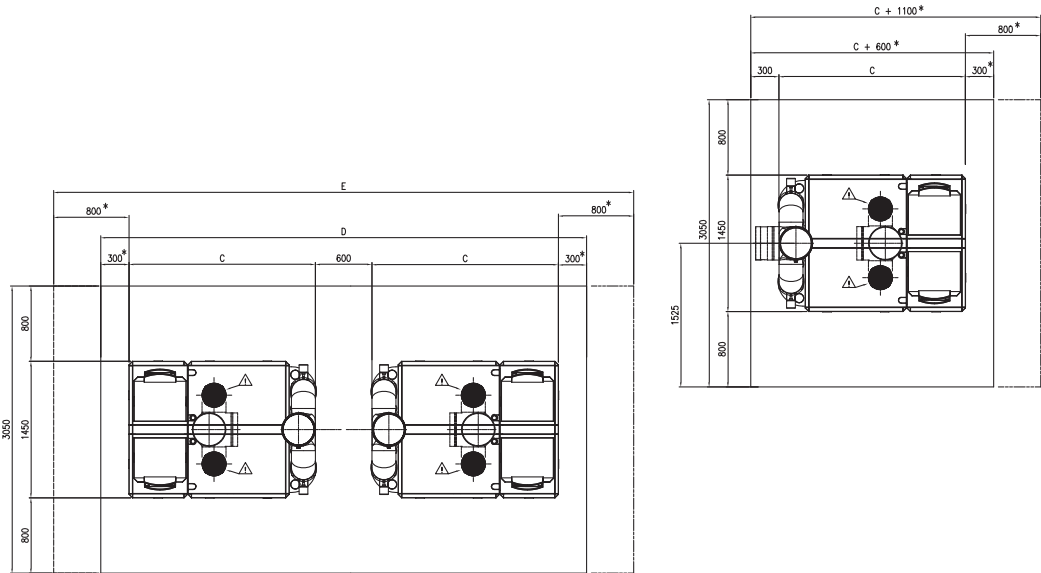

Layout in the boiler room

Clearance of at least 800 mm is required at the front (service side) of each boiler module. However, we recommend a clearance of 1 m. A clearance of at least 400 mm above the boiler and at least 300 mm on both ends (800 mm if the instrument panel is rotated to face the short end). An isolating gas main cock must be installed near the boiler, within hand's reach.

Number of sections	C in mm	D in mm
2 x 6	1590	1118
2 x 7	1980	1508
2 x 8	1980	1508
2 x 9	1980	1508

Base dimensions

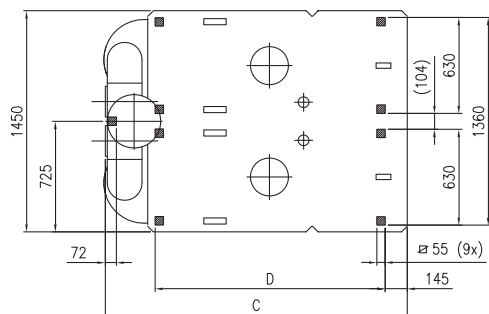

Shows the boiler's support area including the position of the support pads (shaded boxes) supplied.

Remeha Gas 310 ECO

Single boiler conventional flue

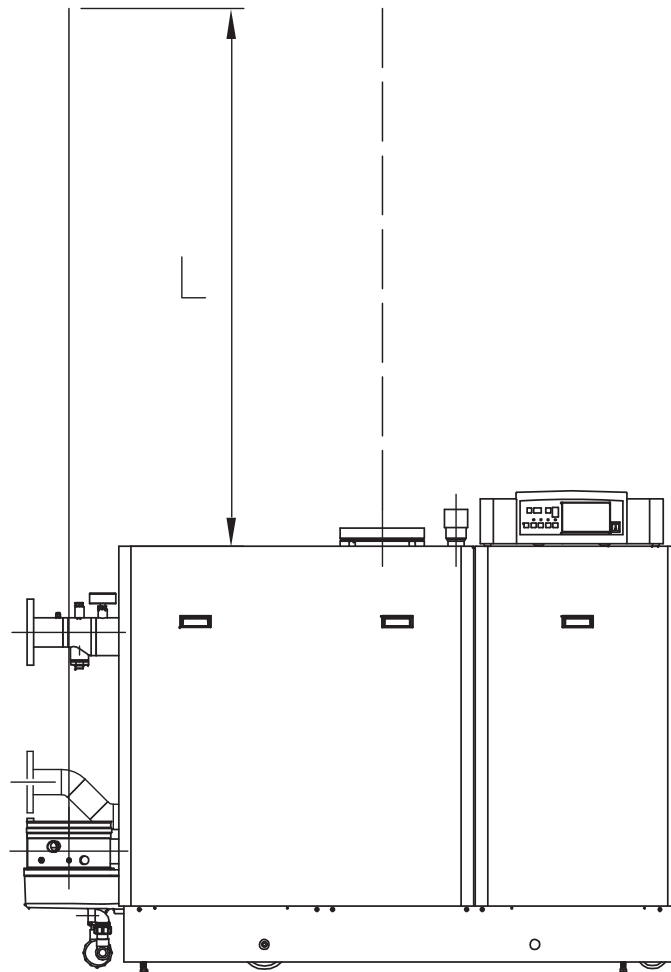

Flue diameter	200mm*			250mm		
		5	6	7	8	9
Model Gas 310 ECO		5	6	7	8	9
max eq. length L	m	103	65	145	105	78
eq. length bend 45°, R=D	m	1.6		2		
eq. length bend 90°, R=D	m	2.8		3.5		

Calculation data conventional flue

* Please note that when a flue with a diameter of 200mm is used an optional adapter is required from 250mm to 200mm diameter.

Remeha Gas 310 ECO

Single boiler room sealed flue

Flue/air inlet diameter		250/250mm				
Model Gas 310 ECO		5	6	7	8	9
max total length of air inlet and flue gas outlet pipework L	m	172	108	71	49	34
eq. length bend 45°, R=D	m	2				
eq. length bend 90°, R=D	m	3.5				

Calculation data room sealed applications

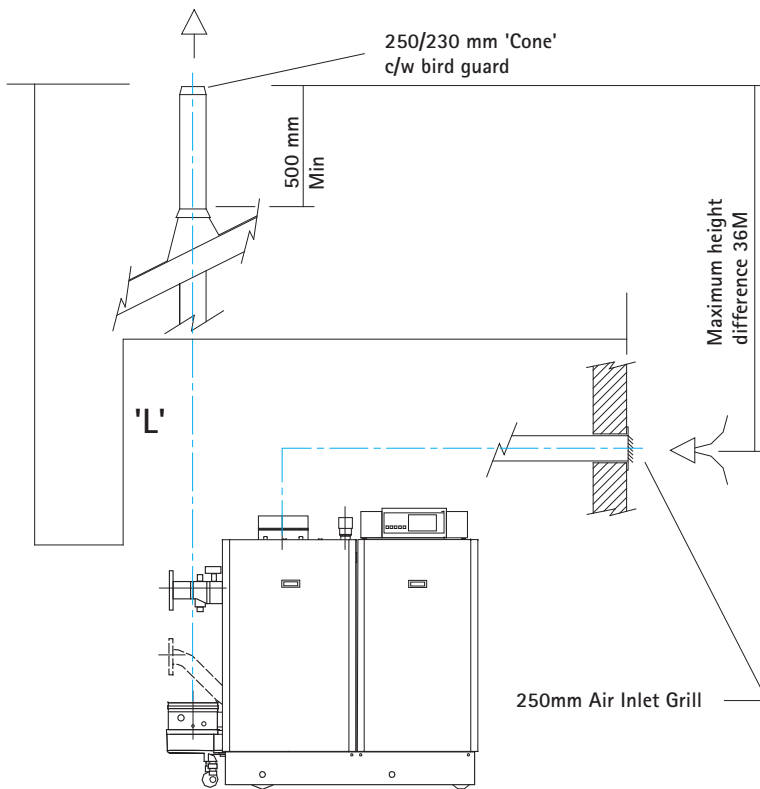

Room Sealed Operation CLV (two zone)

Flue/air inlet diameter		200mm*		250mm		
Model Gas 310 ECO		5	6	7	8	9
max total length of air inlet and flue gas outlet pipework L	m	262	158	98	62	40
eq. length bend 45°, R=D	m	2				
eq. length bend 90°, R=D	m	3.5				

Different pressure zones

* Please note that when a flue with a diameter of 200mm is used an optional adapter is required from 250mm to 200mm diameter.

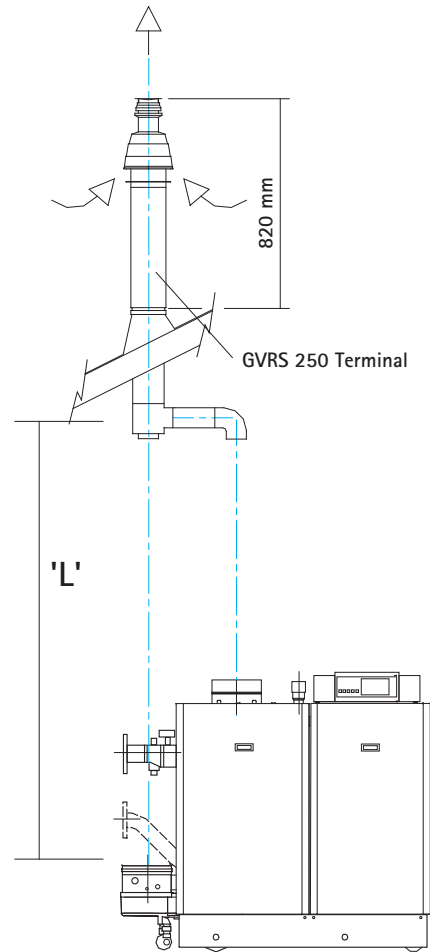

Room Sealed Operation (concentric)

Remeha Gas 610 ECO

Single boiler conventional flue

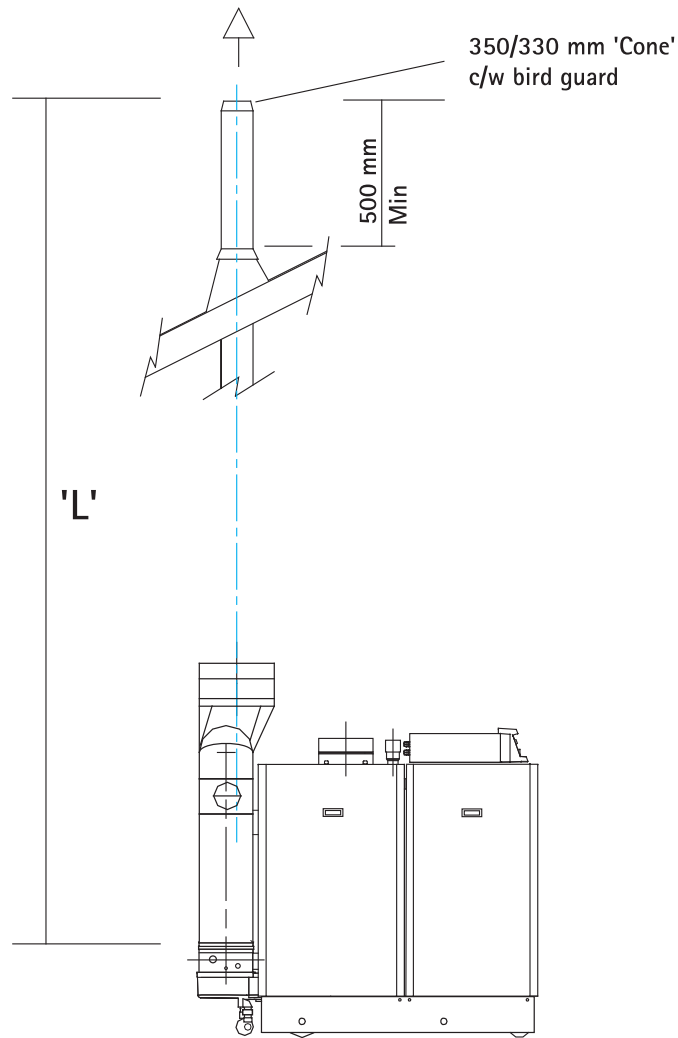

Conventional Flue

Flue diameter		350mm			
Model Gas 610 ECO		2x6	2x7	2x8	2x9
max eq. length L	m	286	183	122	81
eq. length bend 45°, R=D	m	3.2			
eq. length bend 90°, R=D	m	5.6			

Calculation data conventional flue

Remeha Gas 610 ECO

Single boiler room sealed flue

Flue/air inlet diameter		350/350mm			
Model Gas 610 ECO		2x6	2x7	2x8	2x9
max total length of air inlet and flue gas outlet pipework L	m	134	79	46	24
eq. length bend 45°, R=D	m	3.2			
eq. length bend 90°, R=D	m	5.6			

Room sealed operation

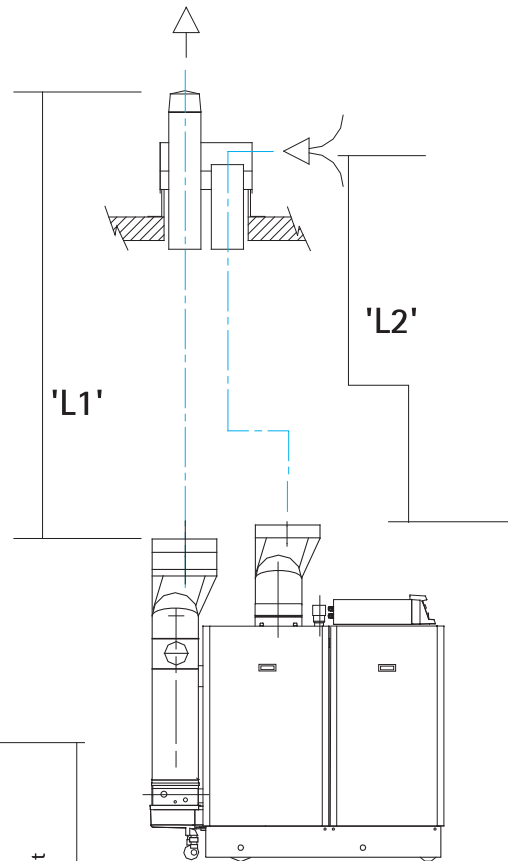

Room Sealed Operation
GVRS 350 roof terminal

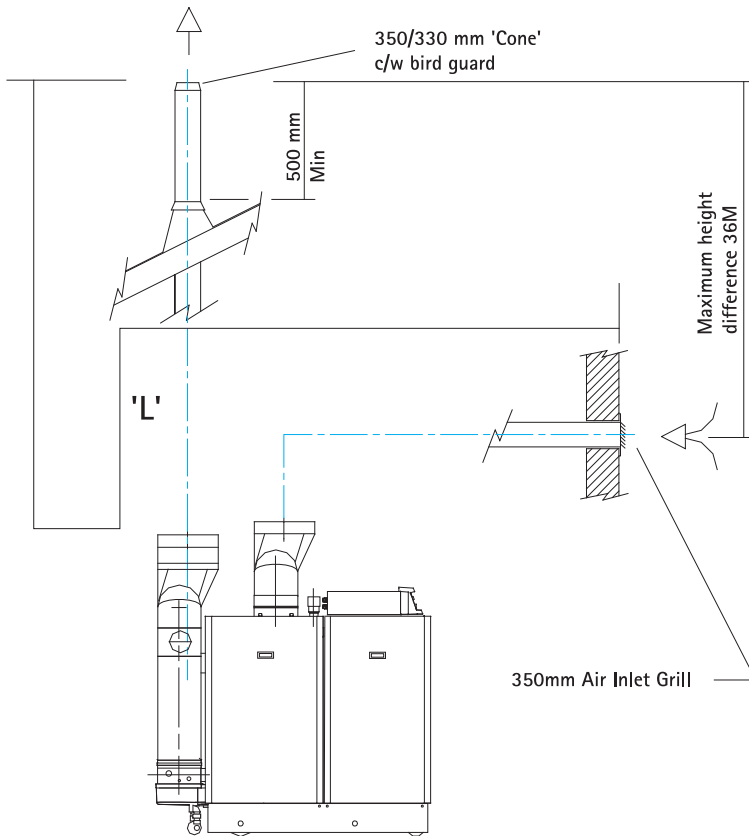

Room Sealed Operation
CLV (two zone)

Flue/air inlet diameter		350/350mm			
Model Gas 610 ECO		2x6	2x7	2x8	2x9
max total length of air inlet and flue gas outlet pipework L	m	168	78	24	-
eq. length bend 45°, R=D	m	3.2			
eq. length bend 90°, R=D	m	5.6			

Different pressure zones

Electrical connections and controls

Remeha Gas 310/610 ECO

General specifications

Note: General specifications apply to each boiler module on the Remeha Gas 610 ECO

The Remeha Gas 310/610 ECO boilers are supplied as standard with electronic operating and flame ionisation safety controls with a specially designed microprocessor at the heart of the system.

The boilers are pre-wired. All external connections can be made on the terminal strips (one low voltage 24v AC and one mains voltage 230v AC).

Power supply

The boilers are suitable for a 230V-50Hz supply with phase/neutral/earth. Other connection values are only acceptable if an isolating transformer is installed. The boilers are sensitive to phase/neutral and therefore have a facility to ensure that phase and neutral are correctly connected. If phase and neutral are crossed, the display will flash L-n / n-L alternately.

Automatic controls

Manufacturer: Honeywell

Type: MCBA 1458 D

Mains voltage: 230 V/50 Hz

Safety time: 3 sec.

The Remeha Gas 310/610 ECO have a unique "boiler code". This together with other data (incl. boiler type, counter readings, etc.) are stored in a "GM-key" that belongs to the boiler. If the control unit is replaced, the counter readings remain stored in the GM-key.

Power consumption

Power consumption at stand-by /part load /full load min (All boilers):

- 5 sections: 12 Watt / 303 W
- 6 sections: 12 Watt / 340 W
- 7 sections: 12 Watt / 470 W
- 8 sections: 12 Watt / 600 W
- 9 sections: 12 Watt / 858 W

2x6 sections	min 24 Watt	max 694 Watt
2x7 sections	min 24 Watt	max 980 Watt
2x8 sections	min 24 Watt	max 1240 Watt
2x9 sections	min 24 Watt	max 1684 Watt

Fuse specification

The control unit contains the following fuses:

- F1 - 2 AF mains voltage fuse (automatic fuse)
- F2 - 2 AT for gas valve multiblock
- F3 - 2 AT for 24 V circuit.
- F10 - 2 AT for shunt pump
- F11 - 1 AT for flue gas damper
- F12 - 1 AT for butterfly valve
- F13 - 2 AT for heating pump
- F14 - 1 AT for external gas valve

The boiler fuse F_a is located next to the 230V terminal strip. This fuse de-energises the whole boiler and has a rating of 10 AT.

The fan has Power Factor Control (PFC ensures that the mains supply is distributed more uniformly) and is fused with a 6.3 AT fuse F_b (next to the 230V terminal strip).

Temperature control

The Remeha Gas 310/610 ECO boilers are equipped with electronic temperature controls based on flow, return, boiler block and flue gas temperature sensors. The flow temperature is adjustable between 20°C and 90°C (factory setting 80°C).

Low water level protection (flow and content)

The Remeha Gas 310/610 ECO boilers are equipped with low water protection based on temperature differences (Δt) between flow and return. When the $\Delta t = 25^\circ\text{C}$ (factory setting) the boiler starts modulating down so that it remains operational as long as possible. When the $\Delta t = 40^\circ\text{C}$ the boiler will be at part load. If the Δt continues to rise and reaches 45°C , the boiler shuts down (not a boiler failure, see technical booklet) and will restart when conditions return to normal.

If the boiler is fired dry, it will go to high temperature lock out, failure code 97.

High limit protection

The high limit temperature protection device switches off and locks out the boiler (showing a flashing fault code) when the flow temperature exceeds the high limit set point. When the fault is corrected, the boiler can be restarted by using the reset-key on the control panel.

Air pressure differential sensor (LDS)

At the start of a heat demand the system checks whether the LDS input is open. If not, there are (max.) four restarts, before the boiler is locked out.

If the LDS input is open, the fan will speed up and a pressure difference is built up across the boiler. When the LDS control speed is reached the LDS input must close. If not, there are (max.) four restarts, before the boiler is locked out.

Once started the LDS function is switched off for modulation purposes.

Connections

The terminal strips and boiler connectors can be seen once the control box cover is removed. The left-hand terminal strip (X29) is used for 24 volt connections. The right-hand terminal strip (X27) is used for 230 volt connections. The external connections are made on these terminal strips. The various connection options are detailed in the following sections.

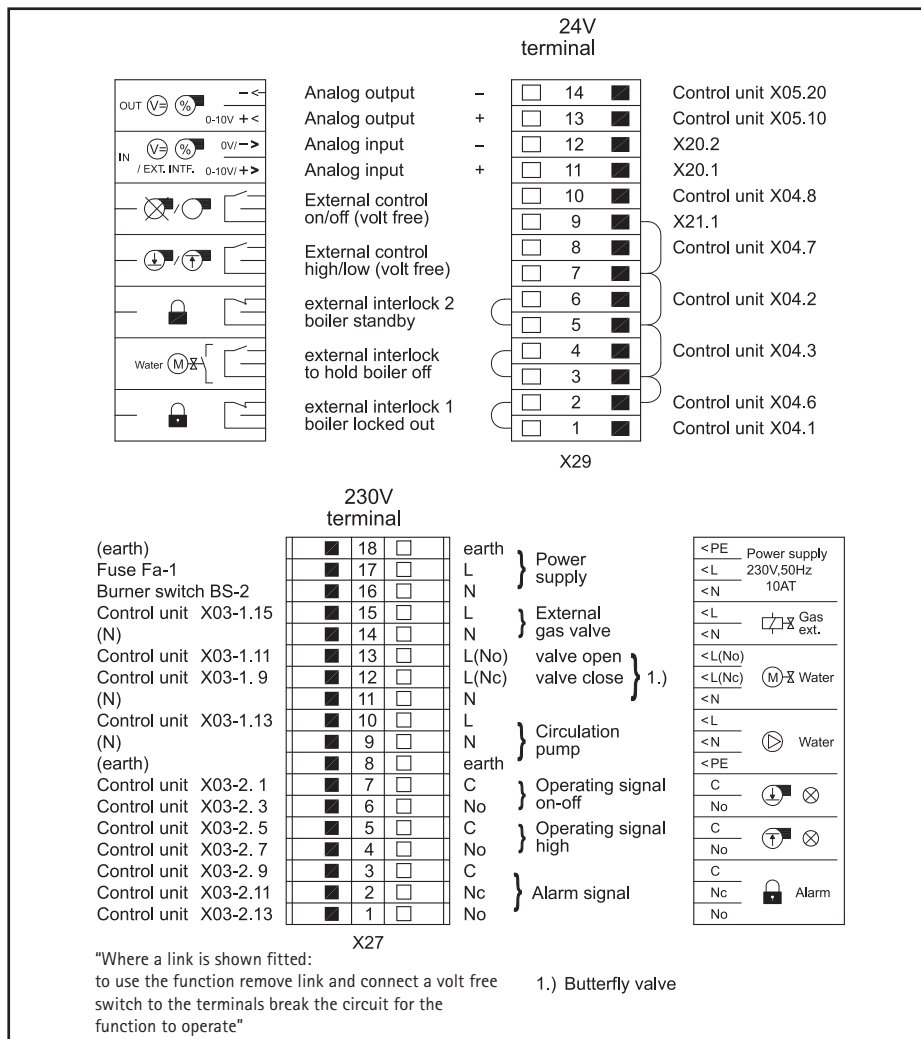

Controls

The Remeha Gas 310/610 ECO boilers can be controlled using one of the following methods:

Note: This applies to each module on the Remeha Gas 610 ECO.

1. Modulating

- Fully modulating, where the output modulates between the minimum and maximum value on the basis of the flow temperature defined by the modulating controller.

Note: when using on/off control the boiler will also modulate to maintain the flow temp set point.

- Analog control (0-10 volts), where the heat output or temperature is controlled by a 0-10 volt signal.

- On/Off control, (one volt free relay) where the heat output modulates between the minimum and maximum value on the basis of the flow temperature set in the boiler.

- High/low control, (two volt free relays) where the boiler is controlled by means of a 2-stage controller at part load and full load.

In all cases, modulation is based on the required flow temperature and there is a Δt dependent output control with the following characteristic. Up to a Δt of 25°C (factory setting, parameter H) the boiler operates at full capacity. Between Δt full load and Δt part load the output reduces in linear fashion.

- Modulating controls general (two wire control)

To make full use of the boiler's modulating feature a Rematic® control can be connected. These controls will provide optimised time and weather compensation to achieve maximum efficiency and minimum boiler cycling whilst maintaining design condition within the building.

- Rematic® single modulating and multiple boilers controller rematic® 2945 C3 K - an optimising/weather-compensated boiler control for one or multiple boilers (up to a max of 8 x Remeha Gas 310 ECO or 4 x Remeha Gas 610 ECO).

This compensator can regulate the boiler output against outside weather conditions, and provide time and temperature control over the DHW.

The compensator is mounted in one of the boilers and is interfaced to communicate with the boiler's controls via the supplied adapter. On site connection of the supplied outside and common flow sensors complete the installation. Set the X value of the boiler control operation parameter A to 1.

Note: Please refer to the relevant control leaflet for optimising / compensation settings.

2. Analog control (0-10 volts)

The heat output modulates between the minimum and the maximum value on the basis of the voltage supplied by an external analog (0-10V) input. To control the boiler with an analog signal, the signal has to be connected on terminals (x29) 11 and (x29) 12 of the terminal strip in the instrument panel.

- Analog control Remeha Gas 310 ECO.

Two formats are available:

a) Temperature based control-Gas 310 ECO Temperature based (20°C to 90°C) set the X value of the boiler control operation parameter A to 4.

0 to 0.9 Volt = boiler off

1 Volt = Flow temperature set point 10°C.

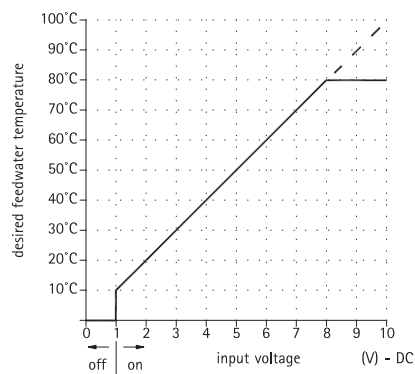

8 Volts = Flow temperature set point 80°C.

Temperature control via analog (0-10 Volt) signal

b) Output based control

Output based - fixed parameters (20% to 100%), Set the X value of the boiler control setting parameter A to 5.

- 0 to 1.9 Volt = boiler off
- 2 Volt - 10 Volt = boiler modulates between 20% and 100% on demand.

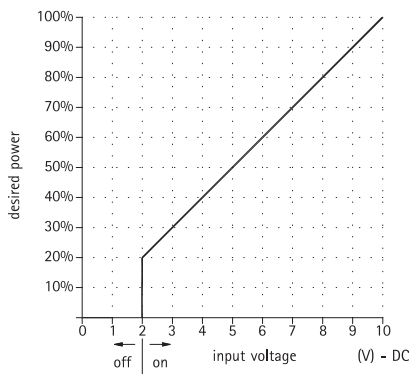

Output control via analog (0-10 Volt) signal

- Analog control Remeha Gas 610 ECO.

Two formats are available:

a) Temperature based control-Gas 610 ECO Temperature based (20°C to 90°C) set the X value of the boiler control operation parameter A to 4.

- 0 to 0.9 Volt = boiler off
- 1 Volt = Flow temperature set point 10°C.
- 8 Volts = Flow temperature set point 80°C.

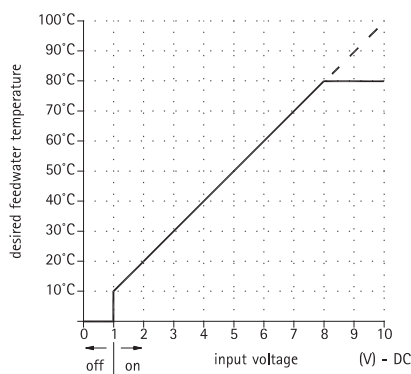

Temperature control via analog (0-10 Volt) signal

b) Output based control

Output based - fixed parameters (30% to 100%), Set the X value of the boiler control setting parameter A to 5.

- 0 to 1.9 Volt = boiler off
- 2 Volt - 10 Volt = boiler modulates between 30% and 100% on demand.

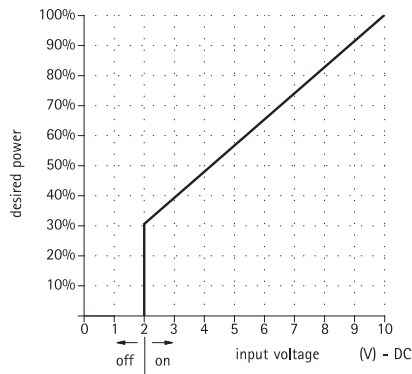

Output control via analog (0-10 Volt) signal

3. On/Off control

- Gas 310 ECO (1 x no volt switched pair)

The heat output modulated between the minimum and the maximum value based on the set flow temperature, terminal connections X29-9 and X29-10.

Set the X value of the boiler control operation parameter A to either 3 (on/off control without booster function) or 1 (on/off control with booster function).

- Gas 610 ECO (2 sets) (2 x no volt switched pair)

The heat output modulates between the minimum and the maximum value based on the set flow temperature, terminal connections X29-9 and X29-10.

Set the X value of each module control operation parameter A to either 3 (on/off control without booster function) or 1 (on/off control with booster function).

4. High/low control

- Remeha Gas 310 ECO (2 x no volt switched pairs)

The heat output is controlled between part load (50%, adjustable) and full load, by means of a two-stage controller, terminal connections X29-9 and X29-10 low fire, X29-7 and X29-8 high fire.

Set the X value of the boiler control operation parameter A to 2.

The output percentage on which the boiler runs on low fire, can be adjusted with parameter 4 (low fire start point as percentage) in the setting mode. The 'high fire' percentage is dependent of the maximal adjusted output, see setting mode, parameter 6 (maximum output). During this 'high' state modulation on adjusted flow temperature is released.

- Remeha Gas 610 ECO (2 sets) (4 x no volt switched pairs)

The heat output is controlled between part load (50%, adjustable) and full load, by means of a two-stage controller, terminal connections X29-9 and X29-10 low fire, X29-7 and X29-8 high fire.

Set the X value of the boiler control operation parameter A to 2.

The output percentage on which each module runs on low fire, can be adjusted with parameter 4 (low fire start point as percentage) in the setting mode. The 'high fire' percentage is dependent of the maximal adjusted output, see setting mode, parameter 6 (maximum output). During this 'high' state modulation on adjusted flow temperature is released.

Safety interlocks

This applies to Remeha Gas 310 ECO and each module on the Remeha Gas 610 ECO

As standard the boilers are supplied with two interlocks.

1. As standard the boilers are supplied with a shut down interlock carrying a 24 Volt AC boiler control circuit. This input does not require manual re-set.

Any external devices required to stop the boiler (e.g. limit switches of throttling valves, minimum gas pressure switches) should be wired in series and connected to terminals X29-5 and X29-6, breaking the circuit will activate the safety interlock and put the boiler into a shut-off condition with code b88. If this input is being used, the wire bridge must first be removed.

2. As standard the boilers are supplied with a lock out interlock carrying a 24 Volt AC boiler control circuit. This input requires manual re-set if activated.

Any external devices required to stop the boiler (e.g. maximum gas pressure switch) must be volt free and should be wired in series and connected to terminals X29-1 and X29-2. Breaking the circuit will activate the safety interlock and put the boiler into a lock out condition, failure code 12 requiring manual intervention to re-set it. If this input is being used, the wire bridge must first be removed.

Input release

The controls include a boiler release input circuit to release the boiler for operation. This input can be used in combination with the limit switches on return water butterfly valve, etc. This input relates to terminals X29-3 and X29-4. Remove the wire bridge before using the input.

Operation signal

As standard the boilers are supplied with internal relays to indicate boiler run and boiler on high fire. The relay contacts are volt free and close to confirm operation.

For the 'boiler on signal' connect to terminals X27-6 and X27-7. For the 'boiler high fire signal' connect to terminals X27-4 and X27-5.

Contact load:

- Maximum voltage: 230 volts.
- Maximum current: 1 Amp.

Common alarm (lock-out)

As standard the boilers are supplied with an internal change over relay to indicate common alarm. The relay contacts are volt free and can be connected to confirm operation with closed or open contacts. For the alarm signal indication "closed contacts" connect to terminals X27-3 and X27-1.

For the alarm signal indication "open contacts" connect to terminals X27-3 and X27-2.

Contact load:

- Maximum voltage: 230 volts.
- Maximum current: 1 Amp.

External gas valve control

As standard the boilers are supplied with an internal relay that is energised when there is a heat demand, this applies a 230V supply to terminals X27-15 (live) and X27-14 (neutral). The relay is de-energised when the gas valve multiblock closes at the end of the heat demand. Additional external interlocks (by others) may be required in a multi boiler installation.

Important!! This supply cannot be used to control an external gas valve if it supplies other appliances.

Contact load:

- External gas valve voltage: 230 Volts.
- Maximum current: 1 Amp.

Optional accessories

Hydraulic pressure sensor

Gas leak switch (VPS)

Minimum gas pressure switch

Flue gas damper

Boiler pump control

The Remeha Gas 310/610 ECO boilers have terminals, which can be used to connect an external boiler pump.

This pump is run once every 24 hours to prevent sticking (24 hour pump operation).

Note: These connections can only be used as boiler pump connections for the Remeha Gas 610 ECO, or when the Remeha Gas 310 ECO is used in multiples.

The pump must be connected to terminals X27-8, X27-9 and X27-10 .

The post-circulation time of the heating pump at the end of a heat demand can be set according to requirements by means of a program option at user level.

Important!! phase/neutral sensitive!

Contact load terminals X27-9 and X27-10:

Voltage : 230 volts

Maximum current : 2 A

Frost protection

The boiler must be installed in a frost free area to prevent freezing of the condensate drain.

If the temperature of the heating water drops too low the integrated boiler protection activates under the following conditions.

If the boiler flow temperature:

- is below 7°C, the external heating pump connected to the boiler is switched on by the control unit;

- is below 3°C, the boiler is switched on at minimum capacity;

- exceeds 10°C, the boiler and heating pump are switched off again. The pump now has a fixed post-circulation time of 15 minutes.

Important!! This frost protection only protects the boiler. Other measures must be employed to protect the building and system and will depend which parameters are set or what form of external controls are in use.



TreadLightly

ON THE PLANET



The data published in this technical sales leaflet is based on the latest information (at date of publication) and may be subject to revisions. It should be read in conjunction with our full technical brochure (available on request). We reserve the right to continuous development in both design and manufacture, therefore any changes to the technology employed may not be retrospective, nor may we be obliged to adjust earlier supplies accordingly.
Issue 2 date: 01/05/2010

PART OF BDR THERMEA



Broag Ltd. Head Office

Remeha House
Molly Millars Lane
Wokingham
Berkshire RG41 2QP
T: 0118 978 3434
F: 0118 978 6977
E: boilers@remeha.co.uk

www.remeha.co.uk



Remeha is committed to carbon offsetting