

Installation & Servicing Instructions

Q-Solar



These instructions to be retained by user.

Explanations of symbols and signs on the Control Tower display.

	Operation indication	(in the first display position by technical read out)
0	No heat requirement	
1	Ventilation phase	
2	Ignition phase	
3	Burner active on central heating	
4	Burner active on hot water	
5	Fan check	
6	Burner off when room thermostat is demanding	
7	Pump overrun phase for central heating	
8	Pump overrun phase for hot water	
9	Burner off because of too high flow water temperature	
R	Automatic venting programme	
SUN	Solar pump active	
HOT	Maximum cylinder temperature achieved (>80°C)	

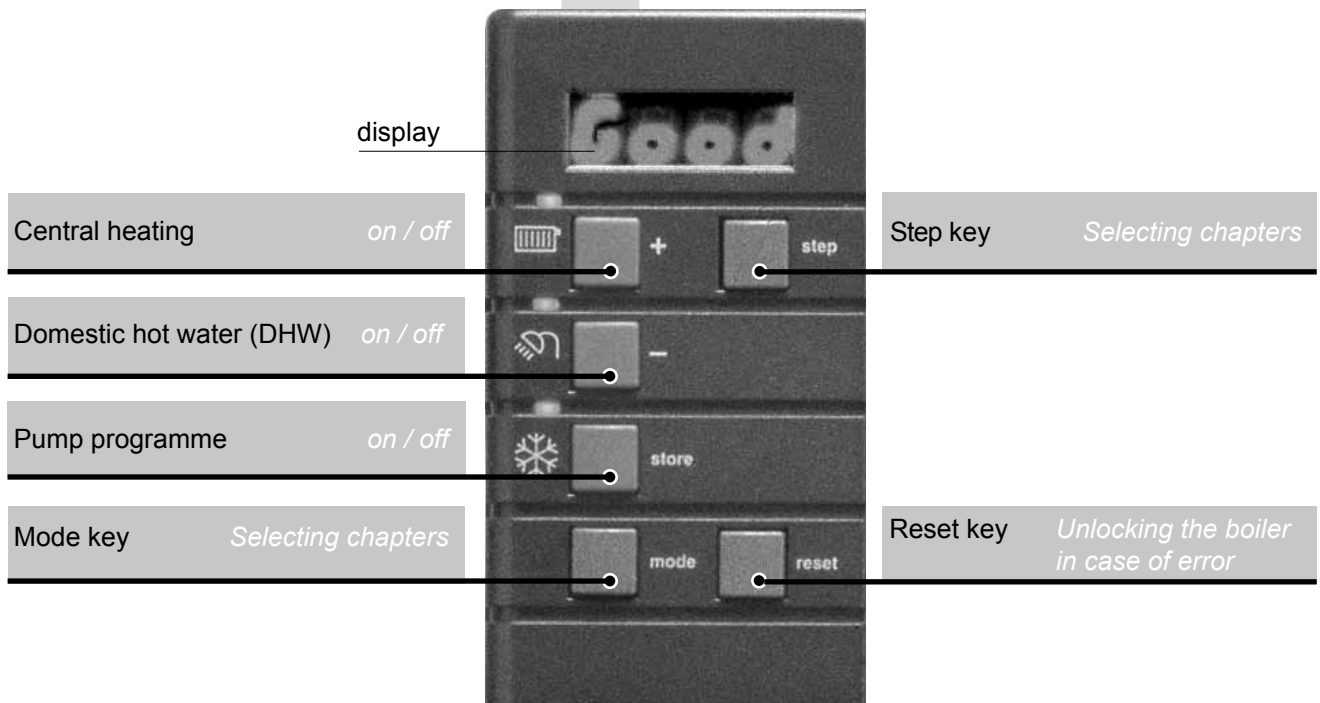

From Good-read out to Technical read out (and vice versa):
- Press 5 sec. on the STEP key.

FILL

Water pressure is too low (<0,7 bar), FILL indication remains continuously visible, the boiler is taken out of operation. The installation needs to be topped up.



Water pressure is too low (<1,0 bar), flashing FILL will alternate with indication of water pressure, boiler power of 50% is possible. The installation needs to be topped up.

HIGH

Water pressure is too high (>2,8 bar), if HIGH indication remains continuously visible, the boiler is taken out of operation. The installation pressure needs to be decreased by draining water.

Content

1	Introduction	4
2	Rules	5
3	Scope of the supply	7
4	Description of the boiler	7
	4.1 Schematic lay out of the Q-Solar	9
5	Mounting the boiler	10
	5.1 Dimensions	11
6	Connecting the boiler	12
	6.1 Central Heating system	13
	6.2 Expansion vessel	14
	6.3 Underfloor heating system (plastic pipes)	15
	6.4 Gas connection	15
	6.5 Hot water supply	16
	6.5.1 Secondary DHW Circulation	17
	6.6 Condensation drain pipe	18
	6.6.1 Condensate discharge	18
	6.7 Flue gas exhaust system and air supply system	20
	6.7.1 Flue system dimensions	23
7	Solar circuit	24
	7.1 Expansion vessel solar circuit	24
	7.2 Filling and de-aerating the solar circuit	24
	7.3 Solar pump	24
8	Electrical connection	25
	8.1 Electrical connections between cylinder and boiler	26
	8.2 Outside sensor (optional)	28
	8.3 Solar absorber sensor	28
	8.4 Calibrating the sensors	28
9	Boiler controls	29
	9.1 Explanation of the function keys	30
	9.2 Solar module	31
	9.3 Functioning of the Solar module	31
10	Filling and venting the installation	32
	10.1 Filling the cylinder (secondary DHW circuit)	32
	10.2 Central heating system (primary circuit)	33
11	Commissioning the boiler	34
	11.1 Central Heating system	34
	11.2 Hot water supply	34
	11.3 Solar circuit	34
	11.4 Adjustments	35
	11.5 Activating factory settings (green key function)	37
12	Isolating the boiler	38
13	Commissioning	38
	13.1 Checking for contamination	39
	13.2 Checking the CO ₂ /O ₂	40
	13.3 Maintenance activities	41
	13.4 Draining the installation	43
	13.5 User's instructions	44
	13.6 Maintenance frequency	44
	13.7 Warranty	44
14	Technical specifications	45
15	Parts of the boiler	46
16	Error indication	48
17	CE Declaration of conformity	49
	Benchmark Checklist	50
	Service Record	51



Work on the installation should only be carried out by qualified personnel with calibrated equipment.

Note:

Handling and storage packages:

- Handle with care. Note the instructions/symbols on the packages

Installation:

- Always read the installation manual before installing the system and putting the system into operation

Technical details:

- See page 11 for dimensions and page 45 for Technical specifications.

These instructions describe the functioning, installation, use and primary maintenance of ATAG central heating units for the United Kingdom and Ireland. Where necessary the different regulations for each country are separately described.

These instructions are intended for the use of a GasSafe Register registered installers or registered Bord Gais installers in connection with the installation and putting into operation of ATAG units. It is advisable to read these instructions thoroughly, well in advance of installation. Separate instructions for use are supplied with the unit for users of ATAG central heating units. ATAG is not liable for the consequences of mistakes or shortcomings which have found their way into the installation instructions or user's manual. Further, ATAG reserves the right to alter its products without prior notification.



When delivering the unit, give the customer clear instructions concerning its use; present the customer with the user's manual and card.

Each unit is fitted with an identification plate. Consult the details on this plate to verify whether the unit is compliant with its intended location, e.g.: gas type, power source and exhaust classification.

On completion of the installation the installer or commissioning engineer must fill out and complete the Benchmark commission section of the boiler log book and hand to customer or end user for future record keeping. The Benchmark log book must also be filled out and completed by the service agent following each service call, and returned to the customer. A copy of the Benchmark commissioning certificate must be returned to ATAG Heating UK Ltd along with the warranty registration card to register the appliance for the standard warranty benefits

Relevant Installation, Service and User manuals:

- ATAG Monopass Flue system individual
- ATAG BrainQ Digital room thermostat
- ATAG MadQ Cascade-/Zone controller

The following regulations apply to installation of ATAG central heating units:



The ATAG Q-Solar is only suitable as an individual heating appliance with DHW supply for houses and small utility applications.

Legislation and Regulations.

Gas Safety (Installation and Use). All gas appliances must by law, be installed by a competent person, eg. Members of Gas Safe Register and in accordance with the current Gas Safety Regulation. Failure to install appliance correctly could lead to prosecution. All Gas Safe registered installers carry a Gas Safe ID card and have a registration number. You can call Gas Safe Register directly on 0800 408 5577.

In addition to the above regulations this appliance must be installed in compliance with the current IEE Regulations, the Building Standards (Scotland Consolidation) Regulations. Regulations and bye laws of the Local Water Authority and the Current Health and Safety Regulation.



The Benchmark Scheme

Benchmark places responsibilities on both manufacturers and installers. The purpose is to ensure that customers are provided with the correct equipment for their needs, that it is installed, commissioned and serviced in accordance with the manufacturer's instructions by competent persons and that it meets the requirements of the appropriate Building Regulations. The Benchmark Checklist can be used to demonstrate compliance with Building Regulations and should be provided to the customer for future reference.

Installers are required to carry out installation, commissioning and servicing work in accordance with the Benchmark Code of Practice which is available from the Heating and Hotwater Industry Council who manage and promote the Scheme. Visit www.centralheating.co.uk for more information.

Ireland:

- Irish standard 813
- Domestic gas installations

The current, Electricity at Work Regulation must be complied with and also be in accordance with the relevant and current editions of the British Standards.

The ATAG Q boiler is a certified appliance and must not be modified or installed in any way contrary to this Installation Manual.

Manufacturers instructions must not be taken in any way as overriding statutory obligations.

The ATAG Q is a central heating solar unit with an integrated hot water function. These units must be connected according to these instructions and all installation norms in respect of the part of the unit to be connected.

Observe the following rules of safety:

- All work on the unit must take place in a dry environment.
- ATAG units must never be in operation without their housing, except in connection with maintenance or adjustments (see Chapter 13).
- Never allow electrical or electronic components to come into contact with water.

Carry out the following tasks during maintenance, etc. to an already-installed unit:

- Shut down all programmes
- Close the gas tap
- Remove the plug from the wall socket
- Close the stop cock of the unit's intake connection

Take note of the following when maintenance or adjustments are needed:

- The unit must be able to function during these activities; for this reason, the unit's supply voltage, gas pressure and water pressure must be maintained. Ensure that these is not a source of potential danger during these activities.



Following maintenance or other activities; always check the installation of all parts through which gas flows (using leak-detection fluid).



Following maintenance or other activities, always replace the housing and secure it with the screw behind the door at the front of the casing.



Any electrical immersion heater installed MUST contain a thermal cutout device that will require to be manually re-set should it operate.

The following (safety) symbols may be encountered in these installation instructions and on the unit:



This symbol indicates that the unit must be stored away from frost.



This symbol indicates that the packaging and/or contents can be damaged as a result of insufficient care taken during transport.



This symbol indicates that, whilst still in its packaging, the unit must be protected from weather conditions during transport and storage.



KEY-symbol. This symbol indicates that assembly or dismantling, must be carried out.



ATTENTION symbol. This symbol indicates that extra attention must be paid in connection with a particular operation.



Useful tip or advice



Gas pipe (yellow)



CH-flow pipe (red)



CH-return pipe (blue)



Cold water pipe (blue)



Hot water pipe (red)



Solar flow pipe (yellow)



Solar return pipe (orange)



Condensate drain pipe (blue)



Expansion vessel pipe (red)

3 Scope of the supply



The boiler is supplied as a 2 part system.

2 Part system Figure 1

The supplied kit is composed as follows:
Part 1:



Supplied parts with cylinder as separate items Figure 2

- Cylinder(3 coils) with casing and integrated:
- Drain valve for boiler.
 - Fill and drain valve for solar circuit.
 - Safety valve for solar circuit.
 - Expansion vessel solar circuit 18 litre.
 - Solar pump with non return valve.
 - Flow restrictor
 - Modulating 3-way valve (VC6940 Solar/CH).
 - Thermostatic mixing valve.
 - Temperature and pressure relief valve.
 - DHW pressure reducing valve.
 - DHW single check valve.
 - DHW expansion vessel.
 - DHW expansion relief valve.

- And:
- Thermometer /thermomanometer.
 - Tundish.
 - Installation manual.

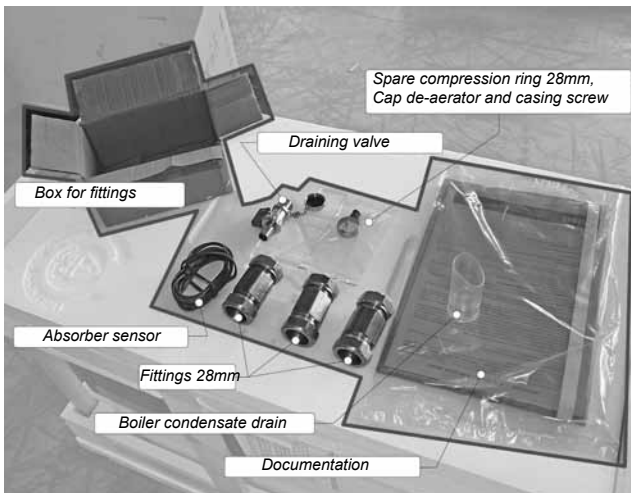

Supplied parts with boiler as separate items Figure 3

- Part 2:
Boiler with casing and integrated:
- Automatic de-aerator;
 - Safety valve;
 - 3-way valve (VC2010 CH/DHW);

- And:
- Fitting 28mm (3x);
 - T-piece 22 x 1/2" x 22 + draining valve;
 - Absorber sensor PT100 ø6mm;
 - Installation manual;
 - Operating manual;
 - Warranty card;
 - Benchmark logbook.

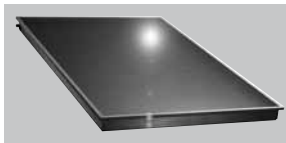

Thermal Absorber

The thermal absorber is not a standard part of the delivery. The thermal absorber should be obtained from a third party. The thermal absorber should fit to the specifications of the Q-Solar.



The supplied absorber sensor PT100 ø6mm should be mounted in the correct position in the absorber. Please contact the supplier of the absorber.

Room sealed boiler
The boiler retrieves its combustion air from outside then discharges the flue gasses to the outside.

Condensing
Retrieves heat from the flue gasses. Water condensates on the heat exchanger.

Modulating
Higher or lower burning according to the heat demand.

Stainless
Super solid kind of steel which keeps its quality for life. It will not rust or erode in contrast to composition materials, like aluminium.

The ATAG Q-Solar boiler is a room sealed, condensing and modulating central heating boiler, with or without an integrated hot water facilities which uses thermal solar power.

The boiler is provided with a compact stainless steel heat exchanger with smooth tubes. A well thought out principal using durable materials.

The boiler burns gas for supplying warmth. The heat is transferred in the heat exchanger to the water in the central heating system. By cooling down the flue gasses condensate is formed. This results in high efficiency. The condensate, which has no effect on the heat exchanger and the function of the boiler, is drained through an internal siphon.

The boiler is provided with an intelligent control system (CMS Control Management System). The boiler anticipates the heat demand of the central heating system or the hot water facility.

When an outside sensor is connected, the boiler reads it and works weather dependantly. This means that the boiler control measures the outside temperature and flow temperature. With this data the boiler calculates the optimal flow temperature for the installation.

The Q-Solar functions in combination with a thermal absorber. The solar circuit is a closed pressurised glycol circuit.

The cylinder is specifically designed and constructed for this purpose. The cylinder should not be used for other purposes.

Solar functioning in short:

The solar pump is activated as soon as the temperature of the absorber is approx. 10°C higher than the temperature in the cylinder ($\Delta T > 10^\circ\text{C}$: pump on). The glycol will be transported from the cylinder through the absorber and back. The glycol is heated in the absorber. The heat is transferred to the sanitary water through the solar coil in the cylinder.

The pump is deactivated as soon as the temperature of the absorber is approx. 2°C higher than the temperature in the cylinder ($\Delta T < 2^\circ\text{C}$: pump off). The pump is also deactivated if all of the sanitary water in the cylinder has reached a temperature of 80°C. This means that there is no chance of overheating! In addition, the cylinder is provided with a T&P valve and the solar circuit is provided with a pressure relief valve.

The heating circuit is supplied with solar warmth from the CH coil in the middle of the cylinder. This is especially suitable for low temperature installations, like under floor heating systems. When the cylinder has sufficient hot water and there is a heat demand for the heating circuit the modulating 3-way valve will be activated. The heating circuit will be supplied by water across the CH coil of the cylinder. If the heat demand is larger than the availability in the cylinder, the heating circuit will be heated by the gas fired boiler.

Explanation of the type indication: ATAG Q38SC380N

Q = Type
38 = Nominal load in kW
SC = SolarCombi
380 = content of the cylinder
N = Not vented glycol solar circuit

A

The boiler has been tested according to valid CE* standards and has a CE* certificate and SEDBUK A-rating.

Statement: No banned materials including asbestos, mercury, CFC's have not or will not be included in the product.

4.1 Schematic lay out of the Q-Solar

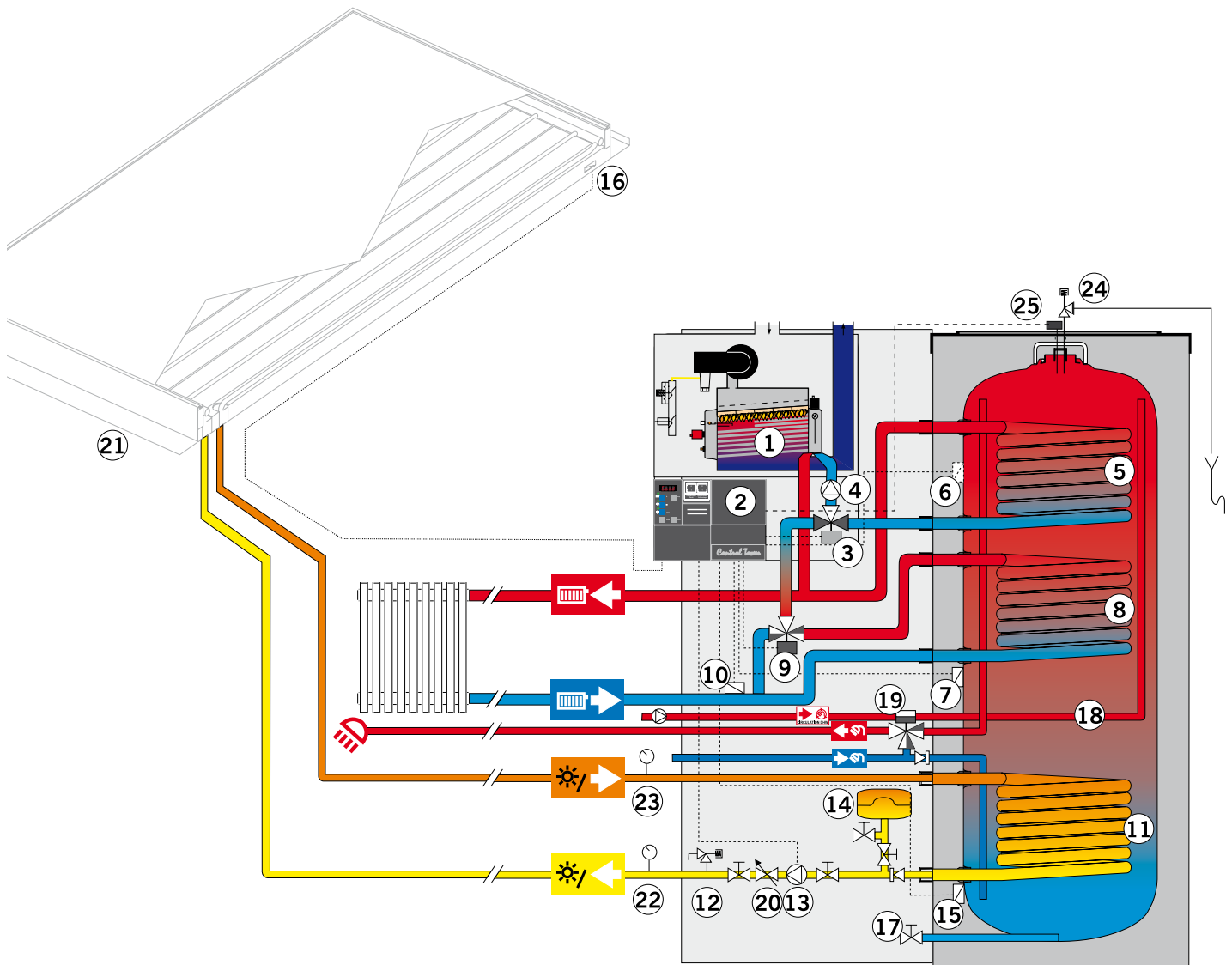

Schematic lay out Q-Solar system

Figure 4

- | | |
|------------------------------------------------------|-------------------------------------------|
| 1. Stainless steel OSS heat exchanger | 14. Expansion vessel |
| 2. Control Management System (CMS) with Solar module | 15. Cylinder sensor Solar (Delta-T) |
| 3. 3-Way valve (CH/DHW) | 16. Absorber sensor Solar (Delta-T) |
| 4. Boiler pump | 17. Cylinder drain valve |
| 5. DHW coil | 18. DHW circulation pipe |
| 6. DHW sensor | 19. Thermostatic mixing valve |
| 7. CH-Solar sensor | 20. Adjustable flow restrictor |
| 8. CH coil | 21. Solar absorber |
| 9. Modulating 3-way valve (CH-Solar) | 22. Pressure/temperature gauge |
| 10. CH-Solar return sensor | 23. Pressure/temperature gauge |
| 11. Solar coil | 24. Temperature and pressure relief valve |
| 12. Drain valve and relief valve solar circuit | 25. High limit thermostat |
| 13. Solar pump | |

The room where the boiler will be placed must always be frost free. To prevent heat loss the boiler should be placed as close as possible to the absorber and, if possible, as close as possible to the most used DHW tap(s).

It is NOT necessary to have a purpose provided air vent in the room or internal space in which the boiler is installed. Neither is it necessary to ventilate a cupboard or compartment in which the boiler is installed, due to the extremely low surface temperature of the boiler casing during operation. Therefore the requirements of BS 6798, Clause 12, and BS5440:2 may be disregarded.

The Q-Solar is a floor standing (upright) boiler. The floor on which the boiler will be placed must be flat and of sufficient strength in order to be able to carry the boiler weight with its total water content.

Above the boiler there must be at least 250 mm working space in order to be able to fit a coaxial flue system or a twin supply. Take account of enough space around the boiler in order to make connections to the boiler and installation, and allowing for access to carry out repair and replacement of components.

- First position the cylinder [section 1] in the desired place and adjust it vertically using the adjustment foot at the bottom of the cylinder.
- Slide the supplied fittings (3x 28mm) on the pipe connections on which the boiler (colli 2) has to be connected. Take note of the right position (see figure 1).
- Lift the boiler (Section 2) and hang it on the 2 suspension points at the top of the cylinder. Ensure that the boiler is correctly attached to these points.



When removing the plastic sealing caps from the pipes, contaminated testing water may be released.



Lift the boiler only by the boilers rear wall.

Lifting and carrying precautions:

- Lift only a manageable weight, or ask for help.
- When lifting the boiler, bend the knees, and keep the back straight and feet apart.
- Do not lift and twist at the same time.
- Lift and carry the boiler close to the body.
- Wear protective clothing and gloves to protect from any sharp edges.

- Slide the fitting upwards until the touch rim and tighten the nuts.
- Move the gas pipe and expansion vessel pipe upwards and connect them. Use only approved fittings on the gas supply.

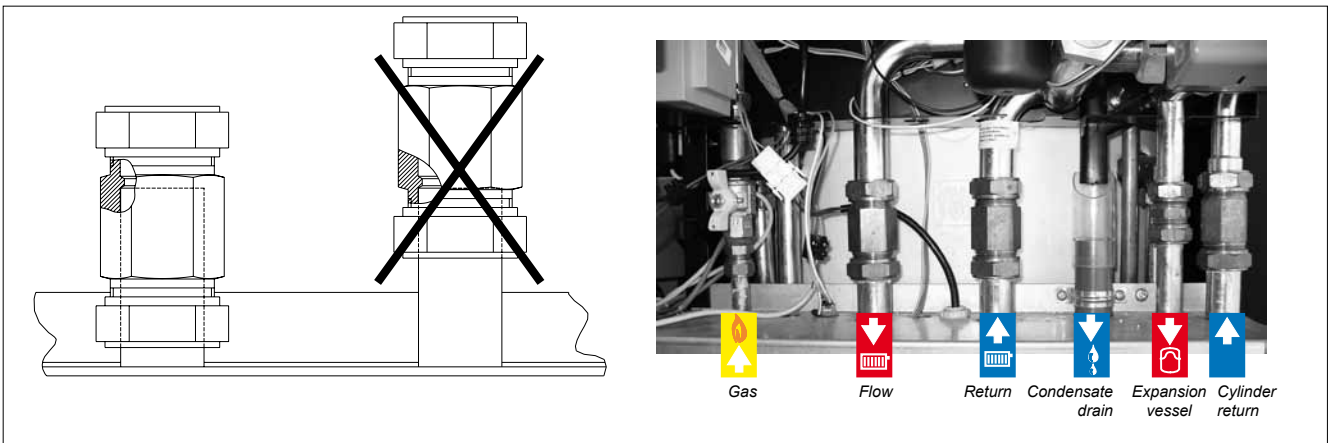

Fittings

Figure 5

5.1 Dimensions

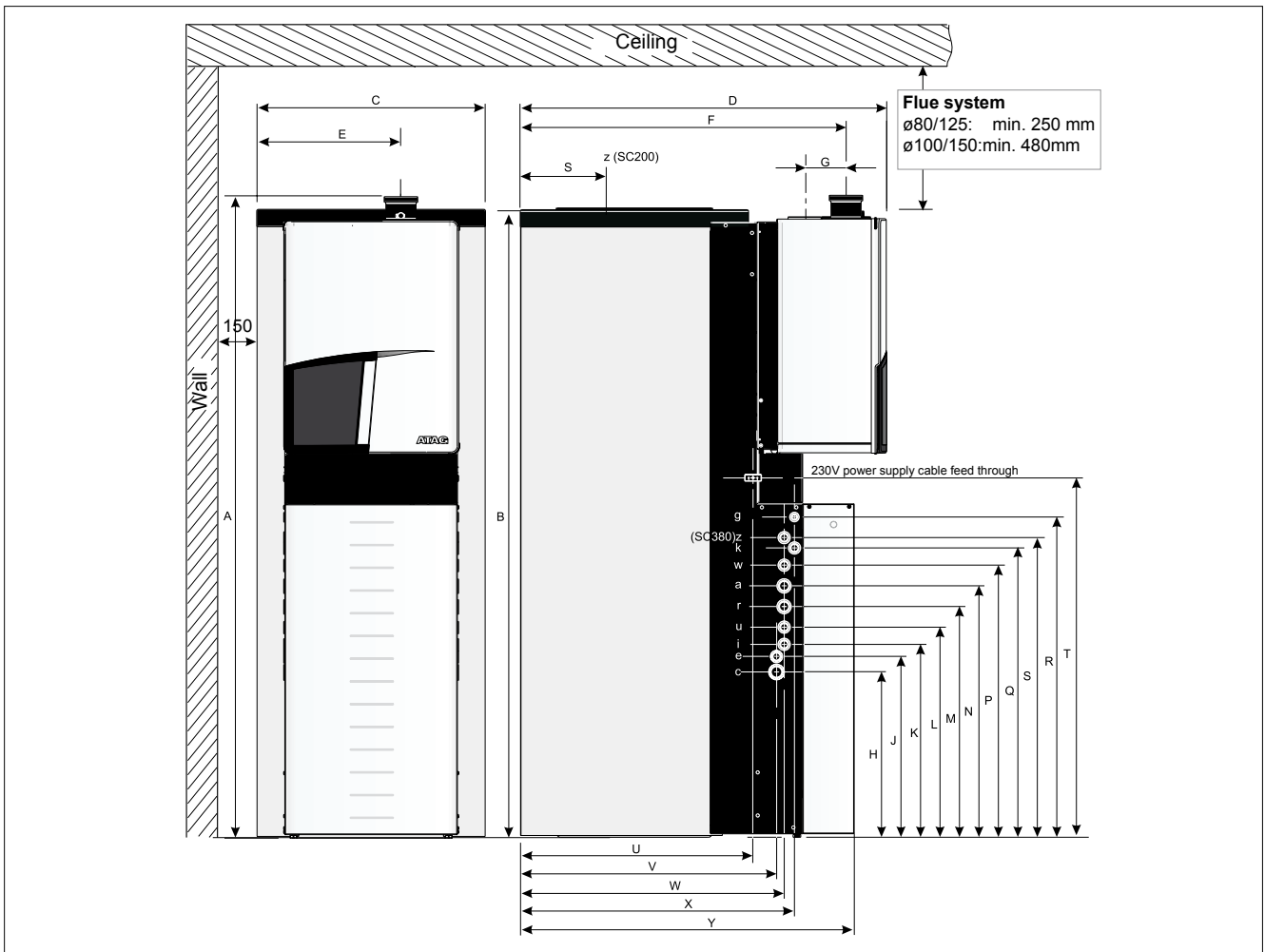

Dimensions Q-Solar (See Table 1 and 2)

Figure 6

Boiler type	Q-Solar	
	Q25SC200	Q25SC380
	Q38SC200	Q38SC380
	mm	mm
A Height total	1880	1860
B Height cylinder	1820	1830
C Width	510	660
D Depth	895	1040
E Left side / Flue gas	340	415
F Back side / Flue gas	780	920
G Centre to centre flue gas and air supply	120	120
H Condensate pipe - c	480	480
J Expansion vessel pipe - e	525	525
K Flow pipe solar absorber - i	560	560
L Return pipe solar absorber - u	610	610
M CH return pip - r	670	670
N CH flow pipw - a	730	730
P DHW pipe - w	790	790
Q Cold water pipe - k	850	840
R Gase pipe - g	930	930
S DHW circulation pipe - z	top side cyl.	870
T Supply cable	1040	1040
U Supply calbe	510	675
V Pipes c and e	580	744
W Pipes i, u, r, a, w and k	600	766
X Pipe g	636	796
Y Front cylinder casing	810	970

Dimensions

Boiler type	Q-Solar	
	Q25SC200	Q25SC380
	Q38SC200	Q38SC380
	mm	mm
Air supply / Flue gas	ø 125 / 80	ø 125 / 80
Flue gas	ø 80	ø 80
Gas pipe - g	ø15 x 1/2"int.	ø15 x 1/2"int.
CH flow pipe - a	ø28x1"ext.	ø28x1"ext.
CH return pipe - r	ø28x1"ext.	ø28x1"ext.
Condensate pipe - c	ø32	ø32
Cold water pipe - k	ø22 x 3/4"ext.	ø22 x 3/4"ext.
DHW pipe - w	ø22 x 3/4"ext.	ø22 x 3/4"ext.
Flow pipe solar absorber - i	ø22	ø22
Return pipe solar absorber - u	ø22	ø22
Expansion vessel pipe CH - e	ø22	ø22
DHW circulation pipe - z	1/2"	ø22

Table 1 Connection diameters

Table 2

The boiler has the following connection pipes, which can be connected left or right to the boiler by means of turning the knee fitting (all connections are positioned to the left from factory);



- The central heating pipes (See figure 7).
These can be connected to the installation by means of the supplied compression fittings(1xT-piece) 28 mm x1" and the 28mmx480mm pipes. The supplied drain valve can be fitted on the T-piece in the return pipe. See further chapter 6.1.



- CH expansion vessel pipe (See figure 7).
On this 22mm x480mm pipe and 22mmx3/4" fitting the CH expansion vessel should be mounted See further chapter 6.2.

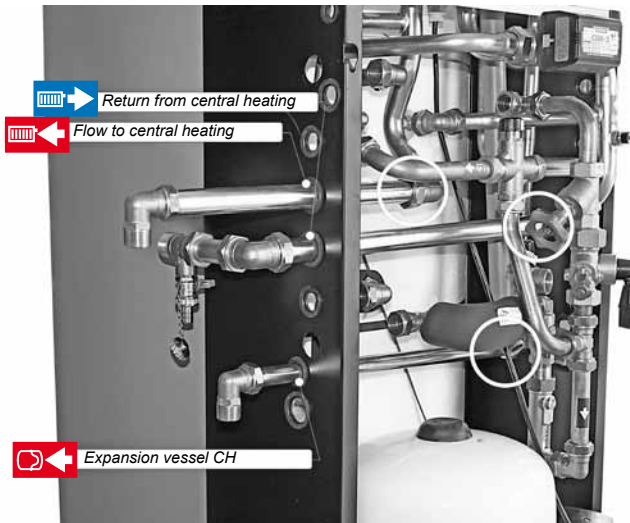

Central heating and expansion connections

Figure 7

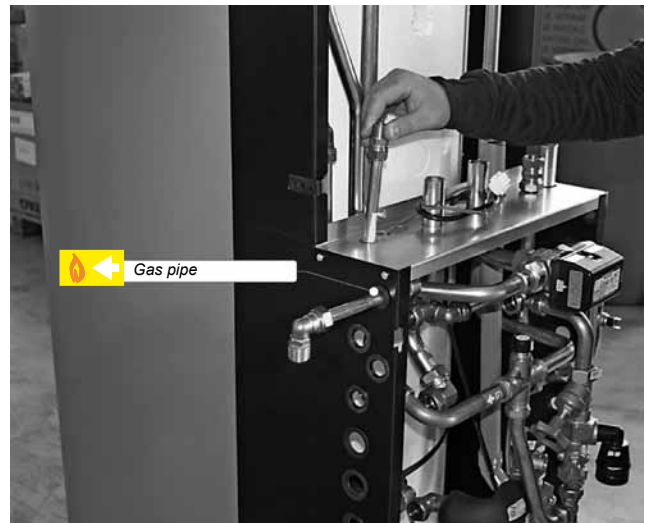

Gas pipe connection

Figure 8



- The gas pipe (See figure 8).
This can be fitted to the boiler with a 1/2"x15mm fitting to the boiler. Outside the boiler the gas pipe has to be provided with a manual gas valve within 1 metre of the boiler. See further chapter 6.4.



- The condensation drain pipe (See figure 9).
It consists of an oval 24 mm plastic pipe. The drain pipe can be connected to this by means of a tundish. The drain pipe is provided with a syphon. The drain pipe can be connected (glued) outside the boiler to a 32 mm PVC drain. See further chapter 6.6.



Condensation drain pipe



Figure 9



- Cold and hot water pipes (See figure 10).
These consist of 22mm copper pipes and can be connected to the installation by means of compression fittings. See further chapter 6.5.

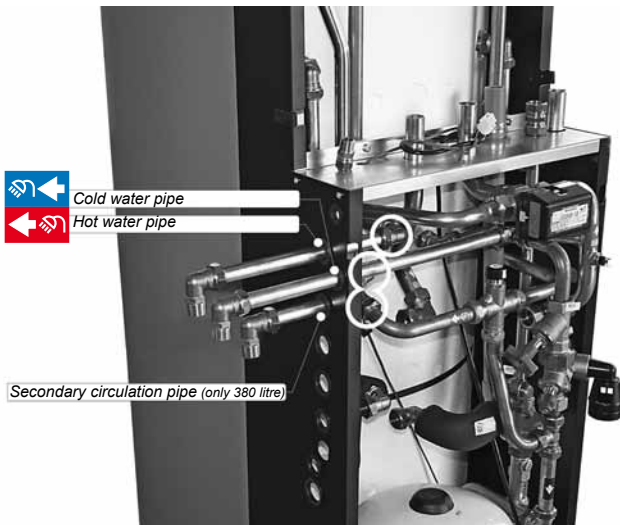

Cold and hot water pipe connections

Figure 10

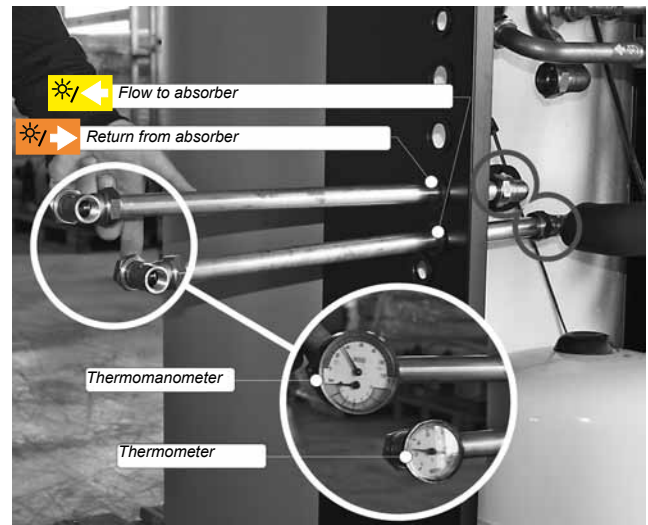

Absorber pipe connections

Figure 11



- Absorber pipes (See figure 11).
These consist of 22mm heat resistant insulated copper pipes. The complete absorber circuit has to be connected with heat resistant 22mm copper pipe with the supplied T-pieces 22mmx22mmx1/2". The supplied thermometer and thermomanometer should be fitted to the T-pieces. See further chapter 7.
- The flue gas exhaust system and air supply system.
It consists of a concentric connection 80/125 mm. See further chapter 6.7.



It is recommended that isolation valves are fitted to all heating and hot water connections to facilitate ease of future maintenance.



It is advisable to spray-clean all of the unit's connecting pipes and/or to spray-clean/blow-clean the installation before connecting it to the unit.

6.1 Central Heating system

Connect the central heating system according to local regulations.

The boiler pipes can be connected to the installation by means of compression fittings. Reducers should be used for connecting to thick-walled pipe (welded or threaded). Install the drain valve with the T-piece in the CH return pipe within reach. It is not necessary to install a heat trap in the central heating pipes. This is already present in the cylinder.

The boiler has a self-adjusting and self-protecting control system for the load and the pump capacity. This means the temperature difference between the flow and return water is checked. Table 3 shows the water displacement which supplies the circulation pump at certain installation resistance.

If the installation resistance is higher than the stated value the pump will rotate at maximum pump capacity and the load will be adjusted until an acceptable temperature difference between flow and return water has been obtained. If, after this, the temperature difference remains too much then the boiler will switch itself off and wait until an acceptable temperature has arisen.

If an unacceptable temperature is detected, then the control will repeatedly try to achieve water flow, and if this does not work then the boiler will switch off.

Boiler type	Pump type	Water flow rate		permissible installation resistance	
		l/min	l/h	kPa	mbar
Q25SC200	UPER 20-60	16,2	972	32	320
Q38SC200	20-70	24,6	1478	16	160
Q25SC380	20-60	16,2	972	32	320
Q38SC380	20-70	24,6	1478	16	160

Installation resistance

Table 3

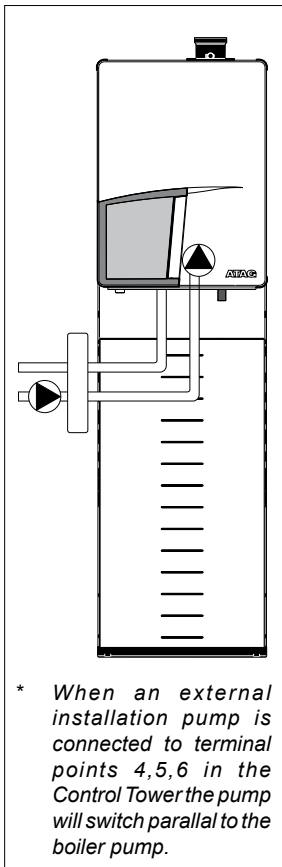

External installation pump with low velocity header

Figure 12

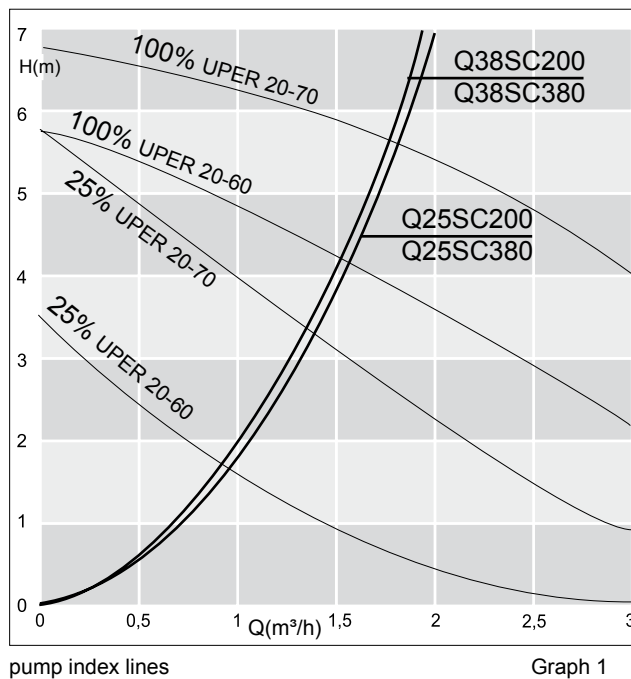

If the capacity of the boiler pump is insufficient, an extra external pump can be installed in combination with a low velocity header in series with the boiler. The electrical side of this external circulation pump can be connected in the Control Tower, by which means this pump switches at the same times as the boiler pump.

The maximum absorbed current consumption of the external circulation pump may be 230 W (1 Amp). The extra external pump must be selected according to the installation resistance and required flow.

As standard the boiler is provided with a water filter in the return pipe of the boiler. With this, possible contamination of the central heating water is prevented from ending up in the boiler. The boiler is also provided with an internal safety valve set at 3 bar. This is connected to the waste discharge together with the condensation discharge.

If all, or a large part of the radiators are provided with thermostatic radiator valves it is advisable to use a pressure difference control (bypass) in order to prevent flow problems in the installation.



The boiler is designed to be used on sealed systems only.



Additives in the installation water are only permitted in consultation with the country distributor. ATAG Heating UK Ltd recommend the use of either Fernox or Sentinel products.

6.2 Expansion vessel

The central heating system must be provided with an expansion vessel. The expansion vessel which is used should be geared to the water content of the installation. The pre-charge pressure depends on the installation height above the mounted expansion vessel. See table 5.

installation height above the expansion vessel	pre-charge pressure of the expansion vessel
5 m	0,5 bar
10 m	1,0 bar
15 m	1,5 bar

choice of expansion vessel

table 5

All Q-Solar boilers are provided with an expansion vessel connection. This pipe is connected between the three way valve and boiler pump. This prevents the expansion water produced during heating or hot water operation from being closed off from the expansion vessel, when the thermostatic radiator valves are fully closed.



In connection with correct functioning of the boiler it is necessary for the expansion vessel to be connected to the expansion vessel pipe of the boiler.

6.3 Underfloor heating system (plastic pipes)

When connecting or using an underfloor heating system, designed with plastic pipes, or plastic pipes are used elsewhere in the installation, one should ensure that the plastic pipes used comply with the DIN 4726/4729 standard. It is set out in this standard that the pipes may not have oxygen permeability higher than 0.1 g/m³.d at 40°C. If the system does not comply with this DIN standard, the underfloor heating component will have to be separated from the central heating appliance by means of a plate exchanger.

Take care that a system with plastic pipes is well de-aerated and remains well de-aerated.



No recourse can be made to the terms of the warranty in the event of failure to observe the regulations pertaining to plastic underfloor heating pipes.

6.4 Gas connection

Determine the correct diameter of the gas line and connect it to the boiler along with a gas isolation valve within 1 metre of the boiler.

United Kingdom:

The gas supply must comply to the current Gas Safety Installations & Use Regulations.

Ireland:

- Irish standard 813
- Domestic gas installations

The connection to the appliance must include a suitable method of disconnection and a gas control cock must be installed adjacent to the appliance for isolation purposes. The nominal inlet working gas pressure measured at the appliance should be 20 mbar for Nat gas (G20).



Make sure that the gas pipe work does not contain dirt, particularly with new pipes.



LPG

When the boiler has to be converted from natural gas to LPG, ATAG provides special kits for this purpose. Special instructions are supplied with the kit.



Always check the installation of all of the parts through which gas flows (using leak detection fluid)

6.5 Hot water supply

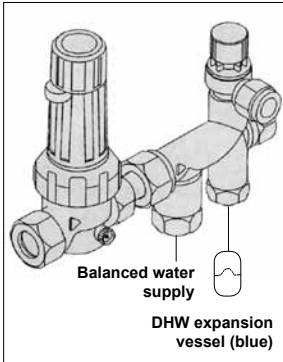

safety group Figure 13

Connection of the drinking water installation should be done according to the national water laws.

The sanitary water pipes can be connected to the installation by means of compression fittings. The cold water inlet must be provided with the supplied DHW safety group (see figure 13) consisting of (counted in the water flow direction):

- Pressure reducing valve with integral strainer
- Check valve
- Core unit
- Expansion vessel 6bar (potable water, blue)
- Expansion valve with tundish

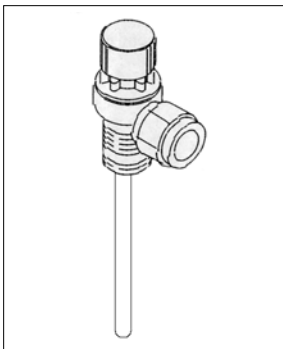

T&P valve Figure 14

The cylinder is provided with a temperature and pressure relief valve (T&P valve) on top of the cylinder (see figure 14).

Install the tundish of the T&P valve according figure 16 and table 6.



tundish Figure 15

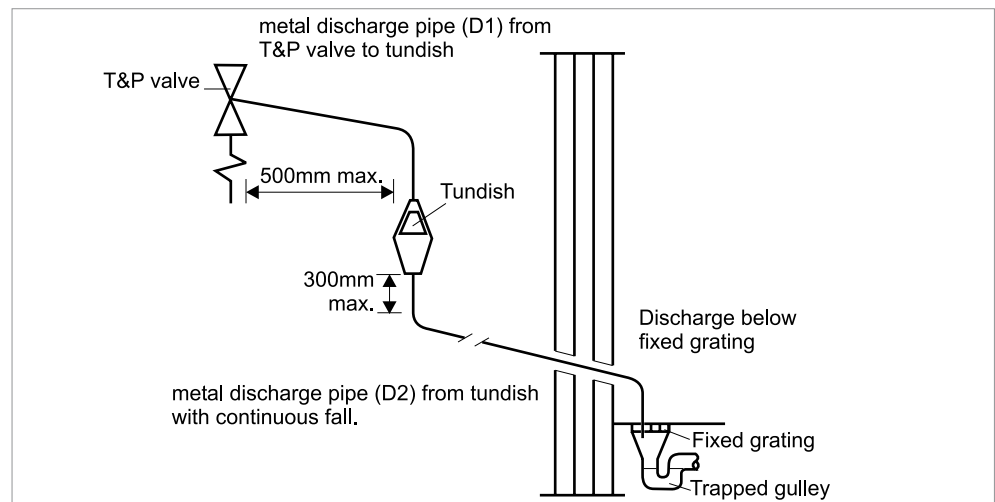

installation of the T&P valve tundish

Figure 16

Valve outlet size	Minimum size of discharge pipe (D1)	Minimum size of discharge pipe from tundish (D2)	Maximum resistance allowed, expressed as a length of straight pipe	Resistance created by each bend or elbow
G 3/4"	22mm	28mm	up to 9m	1.0m
		35mm	up to 18m	1.4 m
		42mm	up to 27m	1.7m

dimensions discharge pipes T&P valve

table 6



Above mentioned items may be used for their specific purposes only and have to be visible to occupants and kept away from electrical devices.

If a DHW secondary circulation line has to be installed take account of the extra volume regarding the size of the expansion vessel.



Cylinder relief valve connections should not be used for any other purpose and no valve should be fitted between the expansion valve and the storage cylinder.



Thermosat and thermal cut-out are integrated in the boiler and may not be changed. Therefore it is not allowed to fit an immersion heater.



Take account of the hardness of the water. Take precautions to prevent scaling in the cylinder.

In regions with a water hardness value higher than 267ppm (2,67 mmol/l), calcium deposits should be removed from the cylinder on a regular basis. If problems occur when using sanitary water with a chlorine content higher than 150 mg/l, no recourse can be made to the terms of the warranty.

The hardness of the water is variable in Great Britain and Ireland. The water company can provide exact information about this.

6.5.1 Secondary DHW Circulation.

In case of long DHW pipe runs one can connect a secondary circulation pipe to the Q-Solar. This improves the comfort because the waiting times can be reduced to a few seconds

The return of this pipe is connected to position Z on the Q-Solar.

The pump of this secondary circulation is not part of the delivery and has to be sourced elsewhere. Please make sure that this is a DHW circulation pump.

It is good practice to put a time clock on the pump so that it only runs during hours of possible hot water usage.

6.6 Condensation drain pipe

ATAG boilers produce condensate. This condensate must be drained otherwise the boiler will not function.

The collecting condensation drain pipe should be connected to the drain by means of an open connection. This means the possibility of drain gases ending up in the boiler is prevented. The drain connection should have a minimum diameter of 25mm.

Connect the condensation drain pipe according to the local regulations.

The following components are connected to the collective condensation drain pipe:

- Condensation discharge;
- Safety valve;



Draining of the condensation water to the external rain guttering is not permitted in view of the danger of freezing.



Before putting the boiler into operation fill the siphon with 300 ml of water.



The condensate pipe must be run using suitable corrosion resistant materials (eg. plastic).

6.6.1 Condensate discharge

ATAG Condensing boilers have the top SEDBUK band A Classification for high energy efficiency in heating and domestic hot water.

All ATAG wall hung gas fired condensing boilers contain a syphonic condensate trap to collect and release condensate.

The amount of condensate formed is determined by the type of boilers and the water temperature produced by the boiler.

Condensate pipework.

Use plastic pipe work of a diameter no less than 25mm.

Routing of the pipe work.

Wherever possible, the condensate pipework should be routed internally to prevent freezing.

The condensate pipework must fall at least 50mm per metre towards the outlet and take the shortest possible route

Support the pipe at least every 50 cm for near horizontal sections and 1 metre for vertical sections

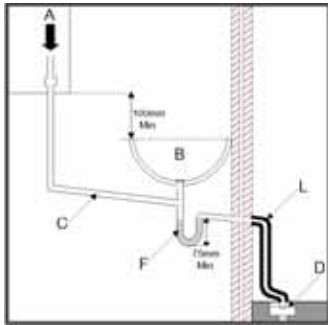

External pipework

The pipework should be kept to a minimum and the route as vertical as possible. Do not exceed 3 metres outside the dwelling. Terminate as close to the ground or drain as possible (below the grating and above the water level) while still allowing for safe dispersal of the condensate. Connection of a condensate drainage pipe to a drain may be subject to local building controls.

Pipework subjected to extreme cold or wind chill conditions should be in a 40mm diameter pipe.

Protect all external pipework with weather resistant insulation and, if necessary, box in, to reduce the risk of freezing.

Making it safe.

Condensate pipework must not leak, freeze or block up. Condensate traps must be filled before firing the boiler to prevent the possibility of potential harmful flue products evacuating via the condensate route. Do not dispose condensate into a water recovery system where it is reclaimed for reuse.

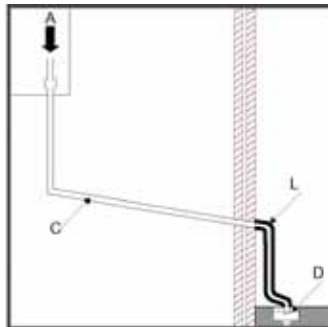

Condensate can be discharged into a rainwater hopper which is part of a sewer carrying both rain water and foul water.

Final discharge options.

The condensate pipe can only terminate into any one of the five areas as shown in the diagrams on this page.

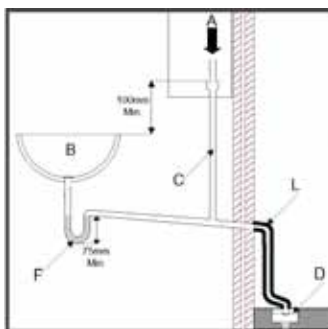
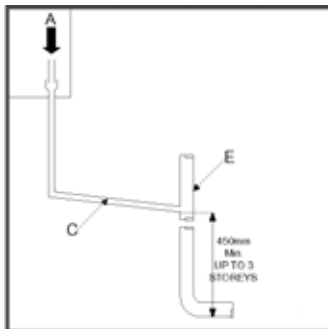

- A -Condensate from boiler syphon/trap
- B -Sink with internal overflow
- C -25mm dia. Plastic condensate pipe
- D -External drain or gully
- E -Internal soil and vent stack.
- F -Servicable condensate trap (75mm min.)
- G -300mm x 100mm dia. sealed plastic tube.
- H -Ground level
- J -Drainage holes facing away from the building
- K -Lime stone chippings
- L -Weather resistant insulation

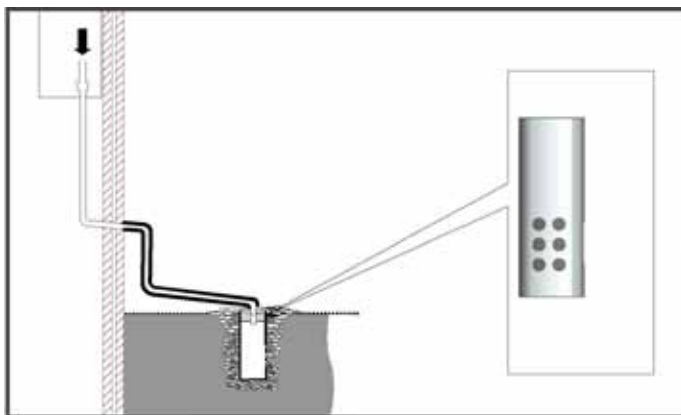

Condensate drain requirements

Figure 17

6.7 Flue gas exhaust system and air supply system

The flue gas exhaust system and air supply system consists of:

- Flue gas pipe;
- Air supply pipe;
- Roof or wall terminal.

The flue gas exhaust system and air supply system must comply with:

United Kingdom:

The flue gas outlet and air supply installation must comply with the current regulation requirements. IG UP 10 and BS 715.

Ireland:

- Irish standard is 813 section 9.10.1

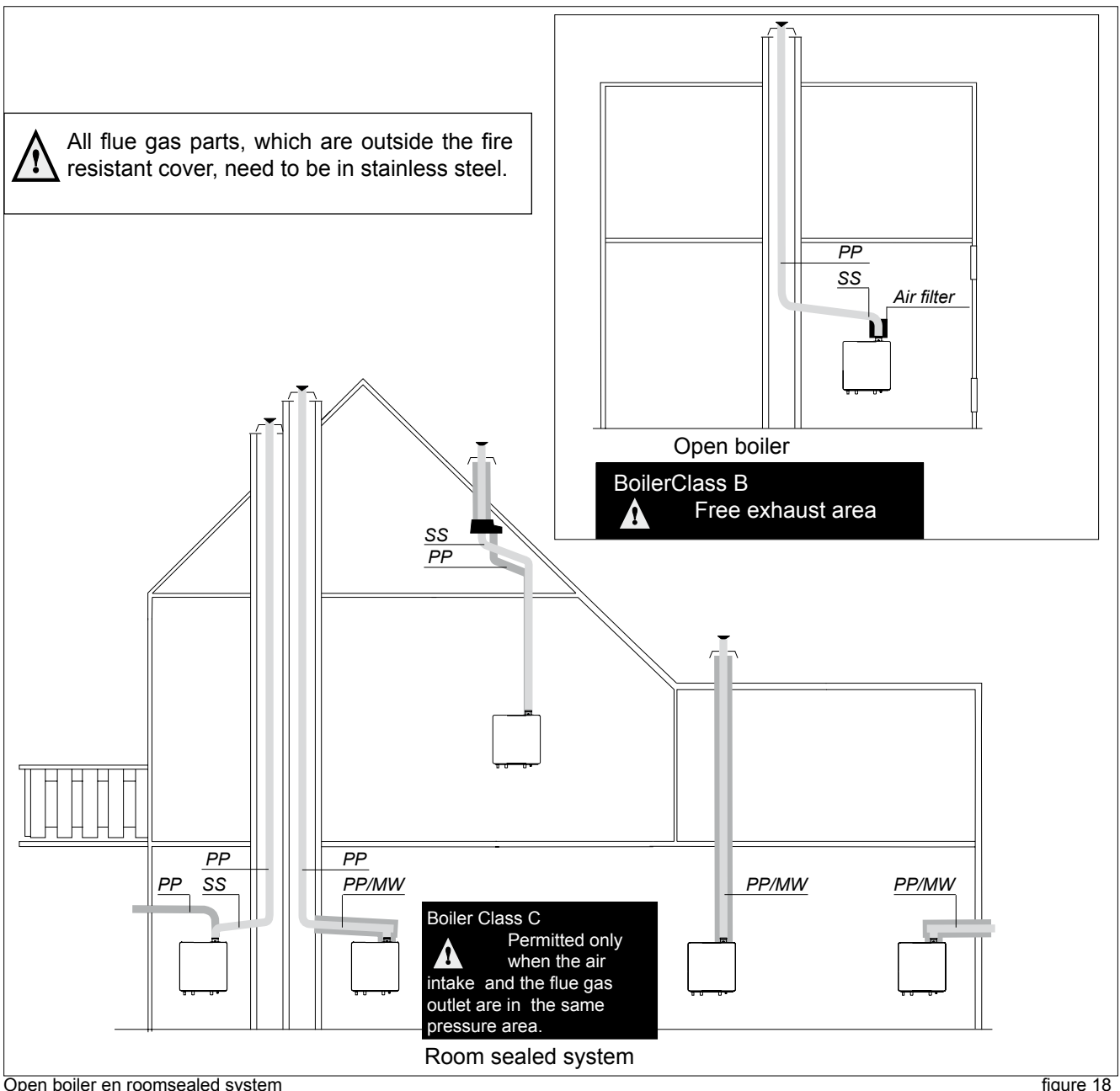

Open boiler en roomsealed system

figure 18

The appliance connection diameter is 80/125 mm, to which the flue gas outlet and air supply system can be fitted, with or without elbow pieces. The maximum permissible pipe length is set out in Table 8.

Boiler conversion from concentric to parallel

It is also possible to use a parallel pipe connection of 2x 80mm. In this case a conversion kit 'concentric to parallel' should be ordered. Art.nr. S4440520.

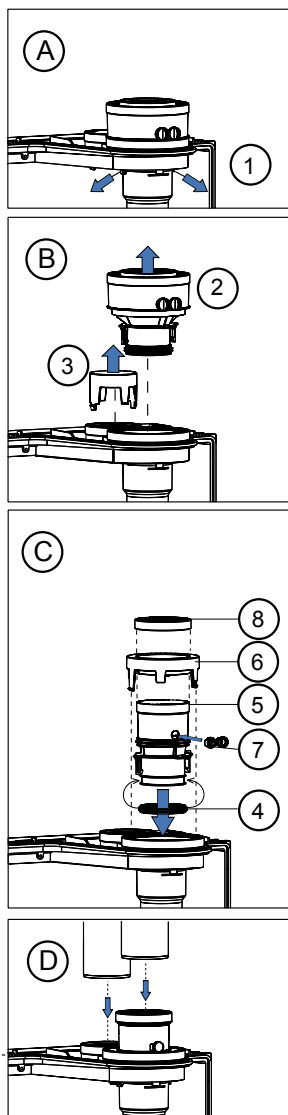

- A. 1. Push the 2 clips slightly outwards.
- B. 2. Pull the concentric adaptor out of the boiler.
3. Press the cover in the connection at the back from inside out.
- C. 4. Pull the rubber seal around the bottom of the flue connector.
5. Push the flue connector in the boiler, in the boiler flue pipe until 'CLICK'.
6. Push the $\varnothing 125\text{mm}$ cover over the flue connector in the $\varnothing 125\text{mm}$ opening until 'CLICK'.
7. Push the rubber plug in open position in the O_2 measuring opening and close the stop.
8. Push the gasket around the top of the flue connector.
- D. Connect the parallel flue gas and air intake system (2x $\varnothing 80\text{mm}$).

Installation & Servicing Instructions ATAG Q-Solar
boiler conversion from
concentric to parallel
figure 19



We suggest you design a simple flue gas system and air supply system using table 6. For further information about the available components of the flue gas and air supply system we recommend you consult the Monopass Flue system literature.

The ATAG flue gas system is ment, and designed, solely for the use on ATAG central heating boilers adjusted to Nat gas or LPG. The maximum flue gas temperatures are below 70°C (full load 80/60°C)

The proper operation may be adversely influenced by changes of or adjustments to the correct set up.

Possible warranty claims will not be honoured if incorrect changes result in non compliance with the installation manual or local rules and regulations.

The flue gas systems described in this document are solely suited for ATAG central heating boilers of the ATAG boiler range. For this purpose the CE Certificate has been supplemented under the Gastec nr: 0063BR3405, 0063BQ3021, 0063AS3538 and 0063AU3110.

The flue gas system should be built up using only ATAG program products. Combinations with other brands or systems are, without written permission from ATAG Heating, not permitted.

Horizontal flue systems should always be installed sloping towards the boiler, in order to avoid condensate lying in the flue system.

The minimum gradient is 50mm/mtr. With the condensate running back to the boiler the risk of ice forming at the terminal is reduced.

The terminal should be located where dispersal of combustion products is not impeded and with due regard for the damage or discolouration that might occur to building products in the vicinity (see figure 20).

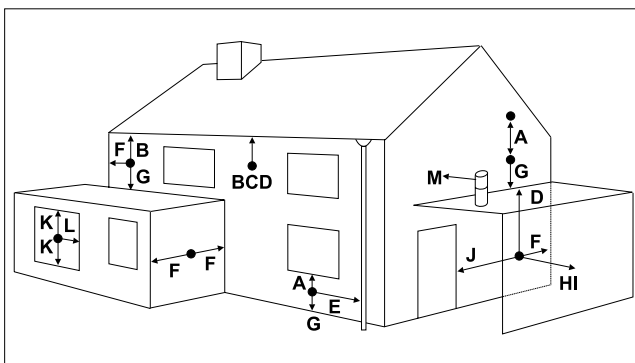

figure 20

terminal position for fan assisted boiler		minimum distance
A	directly below an open window or other opening (e.g. air brick)	mm 300
B	below gutters, soil pipes or drain pipes	mm 75
C	below eaves	mm 200
D	below balconies or car port roof	mm 200
E	from vertical drain pipes and soil pipes	mm 75
F	from internal or external corners	mm 300
G	above ground or below balcony level	mm 300
H	from a surface facing a terminal	mm 600
I	from a terminal facing a terminal	mm 1200
J	from an opening in the car port (e.g. door window) into dwelling	mm 1200
K	vertically from a terminal on the same wall	mm 1500
L	horizontally from a terminal on the same wall	mm 300
M	horizontally from a vertical terminal to a wall	mm 300

In certain weather conditions condensation may also accumulate on the outside of the air inlet pipe. Such conditions must be considered and where necessary insulation of the inlet pipe may be required.

In cold and/or humid weather water vapour may condense on leaving the flue terminal. The effect of such 'plumeing' must be considered.

The terminal must not be located in a place where it is likely to cause a nuisance. For protection of combustibles, refer to IS 813 section 9.10.1. where the terminal is less than 2m (6.6ft) above a pavement or platform to which people have access (including) any balcony or flat roof. The terminal must be protected by a guard of durable material.

A suitable guard is available from the country distributor.



Where a terminal is fitted below a window which is hinged at the top, and where the hinge axis is horizontal, and the window opens outwards, the terminal shall be 1m below the bottom of the window opening.



If the boiler is to be located under stairs, a smoke alarm meeting the requirements of I.S. 409 or equivalent must be fitted.



The flue must be terminated in a place not likely to cause a nuisance.

For horizontal sections, the outlet system should always be fitted on an incline (50 mm/m) sloping down towards the appliance so that no condensation water is able to accumulate in the outlet system. The chances of icicles forming on the roof outlet is minimised by causing the condensation water to run back towards the appliance. In the case of horizontal outlets the inlet system should be fitted on an incline sloping down towards the outside to prevent rainwater from coming in.

The appliance produces a white wisp of condensation (plumeing). This wisp of condensation is harmless, but can be unattractive, particularly in the case of outlets in outside walls.

At this time there are 2 different ways of connecting the flue gas/air intake system. The flue gas duct for the 60/100, 80/125 and 100/150 are push fit connections, see figure 10. The air intake for the 60/100 is a clamp ring connection. These two types are not interchangeable.

Cutting the pipe goes as follows:

- Take out the inner tube by turning it until it releases from its security position;
 - Cut just as much from the air intake part as from the flue gas part;
 - Take off the burrs from the cutting edge to prevent cutting the seals;
 - Click the pipes back together again.
- Use special grease to simplify the fitting

When mounting the flue gas system, pay attention to the flow direction. An arrow on the product points this out. It is not permitted to mount a system upside down and will lead to complaints.

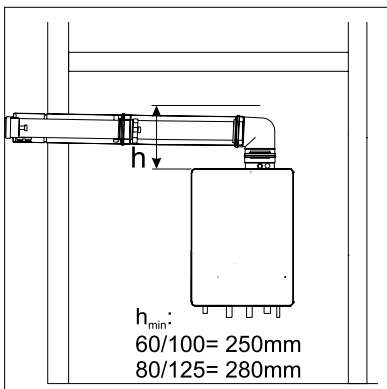
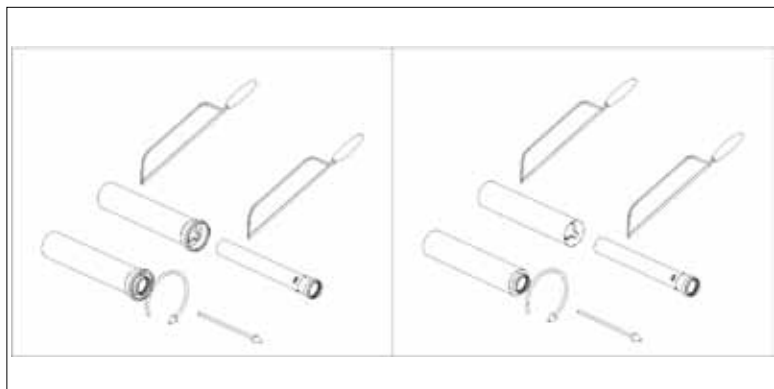

Figure 21



Dismantlement and shorten pipes

Figure 21

6.7.1 Flue system dimensions

The flue diameter is determined by the total length of the run, including for the connection pipe, elbow fittings and terminal covers etc and the type and number of boilers installed into the system.

An undersized flue pipe can lead to disorders. Look at table 8 for the choice of the system and the correct diameter. The table below shows the maximum flue lengths with the different boiler outputs. A longer flue gas length can be achieved by increasing the diameter to \varnothing 100mm.

Explanation table 8:

Two pipe flue gas system: maximum noted length = distance between boiler and roof terminal A

Concentric flue gas system: maximum noted length = distance between boiler and roof terminal B

When using bends the noted value behind every bend should be deducted from the maximum straight length.

Pipes with 60/100 diameter are only permitted on wall terminals in combination with ATAG boilers upto 25kW.

Example:
A 25kW with a concentric flue gas system \varnothing 80/125mm has according to the table a maximum flue straight length of 31m. In the system that is going to be put in there are 2 x 45° bends, so the maximum flue gas length is $31 - (2 \times 1.1) = 28.8$ meters.

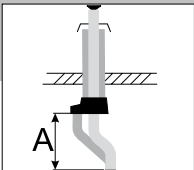
Two pipe flue system + chimney lining					
		\varnothing 80mm		\varnothing 100mm	
			A in m		A in m
16-25 kW		Maximum straight length 80	31	Maximum straight length 100	40
		87° bend resistance length	-1,5	87° bend resistance length	-1,8
		45° bend resistance length	-0,8	45° bend resistance length	-0,9
26-38 kW		Maximum straight length 80	18	Maximum straight length 100	39
		87° bend resistance length	-1,5	87° bend resistance length	-1,8
		45° bend resistance length	-0,8	45° bend resistance length	-0,9

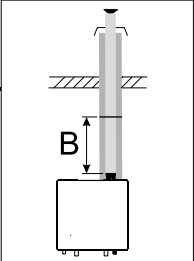
Concentric flue system					
		\varnothing 80/125mm		\varnothing 100/150mm	
			B in m		B in m
16-25 kW		Maximum straight length 80/125	31	Maximum straight length 100/150	40
		87° bend resistance length	-2,8	87° bend resistance length	-2,6
		45° bend resistance length	-1,1	45° bend resistance length	-1,1
26-38 kW		Maximum straight length 80/125	13	Maximum straight length 100/150	34
		87° bend resistance length	-2,8	87° bend resistance length	-2,6
		45° bend resistance length	-1,1	45° bend resistance length	-1,1

Dimensions flue gas system and air supply system

Table 8

7 Solar circuit

The cylinder of the Q-Solar is provided with a system to connect to a glycol solar system. The cylinder can be recognized by the type name on the data plate of the cylinder.

There are 2 types: SC200N and SC380N

N = non vented. This system is a pressurised closed system. The system has to be filled with glycol. Follow the instructions of the supplier of the solar absorber.

7.1 Expansion vessel solar circuit

The cylinder of the Q-Solar is provided with an 18 liter expansion vessel. Take this into account when designing and calculating the solar circuit.

7.2 Filling and de-aerating the solar circuit

Filling and de-aeration of the solar circuit should be executed according to the instructions of the supplier of the absorber.

When the system is filled and de-aerated the switch (Solar) on the Control Tower must be switched on (1).

When the boiler has to be operated without connection to a solar circuit, the switch [solar] on the Control Tower should be switched off [0] and the flat cable should be removed from the Solar Module. The Solar Module [PCB] is situated inside the Control Tower.

7.3 Solar pump

The solar pump is factory set at a pump head of 4 metre. When necessary the pump can be set to a pump head of 6 metre. In this case the electrical bridge in the connection terminal on top of the solar pump should be changed according to figure 22.

Pump head 4 Meter: Bridge between 2-6

Pump head 6 Meter: Bridge between 2-7

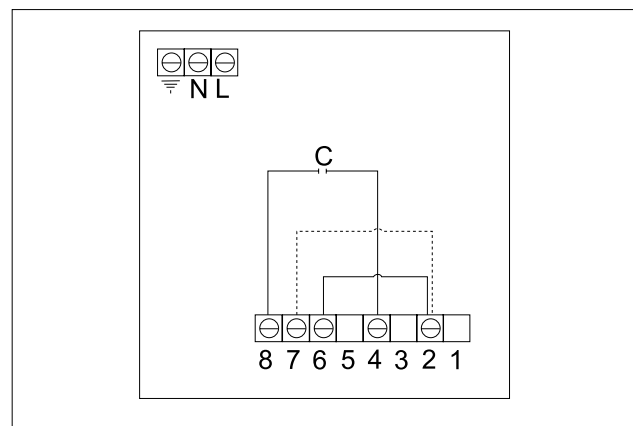

connection terminal solar pump

Figure 22

The appliance complies with the CE Machinery Directive 89/392/EEC. The EC Low Voltage Directive 72/23/EEC and the EC EMC Directive 89/336/EEC.

- A 230V -50Hz mains electrical supply is required fused externally at 5A.
- A deviation on the grid of 230V (+10% or -15%) and 50Hz

The installation must continue to comply with:

United Kingdom:

- the national rules for electrical installations.

Ireland:

- the ECTI national rules for electrical installations

The appliance must be connected to an earthed socket. this must be visible and within reach.

The following general stipulations also apply:

- No changes may be made to the wiring of the appliance;
- All connections should be designed in accordance with the enclosed regulations.;
- Should it be necessary to change it, the mains power supply cable may only be replaced with an ATAG mains power supply cable (item No. S4320100).



The ATAG room thermostat and controls must be connected to their allocated connections. All other types or makes of room thermostats or controls which are used must have a Volt free contact.

When using an on/off thermostat or control, it is possible that an anticipating resistance must be installed in order to prevent too high temperature fluctuations. As a standard rule this means mercury thermostats. This resistance wire is present in the Control Tower and must be connected to clamps 23 and 27. The anticipating resistance in the room thermostat has to be set at 0.11 A.



The high limit thermostat of the cylinder must be connected to clamps 24 and 25.

For more detailed questions regarding the components which are not supplied, the country distributor should be contacted.

Connection terminalQ																											
230 V~ Power Supply			230 V~ External Pump			230 V~ External Controller			230 V~			8G.35.22.02	Calorifier connection				Outside sensor		Brain Smart		Room therm. On / Off		External safety contact		24 V~ 100 mA		
N	L		N	L		N	L		N	L			CH	DHW	N	DHW sensor			A	B	On / Off						
1	2	3	4	5	6	7	8	9	10	11		12	13	14	15	16	17	18	19	20	21	22	23	24	25	26	27
mains power supply			230 Volts for external pump			230 Volts for external control			230 Volts			internal or external three-way valve motor and cylinder sensor				ATAG outside sensor		ATAG room thermostat		On/off thermostat or control (Volt free)		High limit thermostat		24 Volts maximum 100 mA			

Connection terminal

Figure 23

8.1 Electrical connections between cylinder and boiler

The following components should be connected according to figure 24 and 25 with corresponding pictures on next page:

A

- Solar absorber sensor T 7
Pass sensor cable through cable feed A to the side of the cylinder. Connect wires from the absorber to the connector with the green wires. Follow the instructions of the supplier of the absorber.

B

- Solar cylinder sensor T 6
Pass the red sensor cable through cable feed B and connect the wires to the connector with the red cables.

C

- CH - Solar sensor T 8
Pass the white and grey sensor cable through cable feed C and connect the wires to the CH - Solar sensor T 8 on the cylinder.

D

- CH - Solar return sensor T 9
Pass the white and black sensor cable through cable feed C and connect the wires to the CH - Solar return sensor T 9 on the CH return pipe.

E

- Modulating 3-way valve (VC 6940 CH-Solar)
Pass the connector with yellow, purple and blue cable through the cable feed D and connect it to the actuator of the modulating 3-way valve.

F

- Solar pump
Pass the cable from the solar pump through the cable feed E and connect it to the connector behind the Control Tower.

G

- DHW sensor T 3
Pass the sensor cable through the back side of the boiler E and connect it to the DHW sensor on the cylinder.



Caution! When the solar circuit is in operation the solar circuit pipes can reach high temperatures (> 120°C). Prevent physical contact and contact with electrical wiring.



The solar pipe lines should be insulated with UV and temperature resistant material.



Follow the instructions of the supplier of the absorber for correct installation.

Electrical connections boiler to cylinder

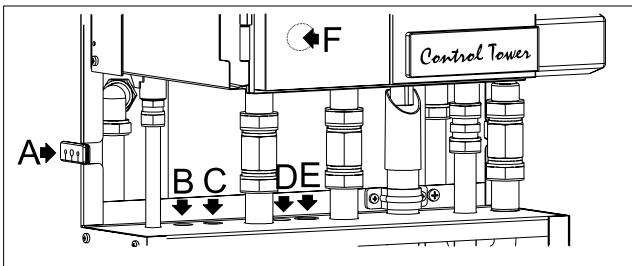
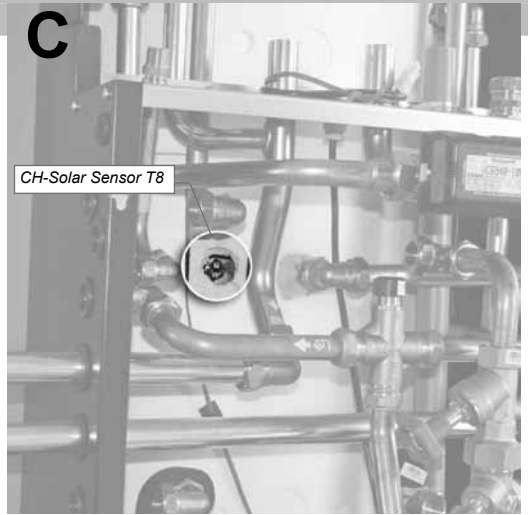
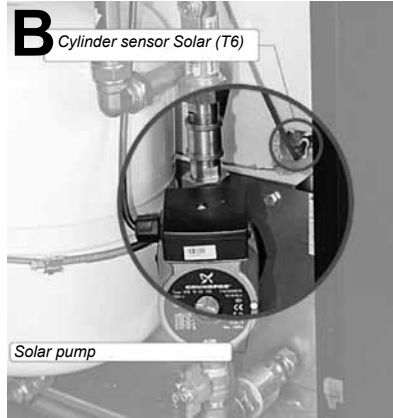

cable feed through

Figure 24

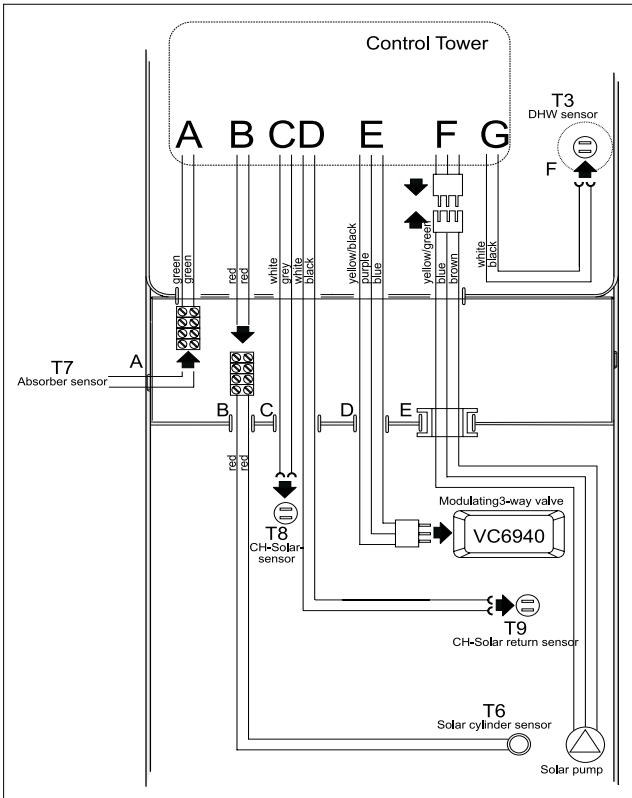

electrical connections

Figure 25

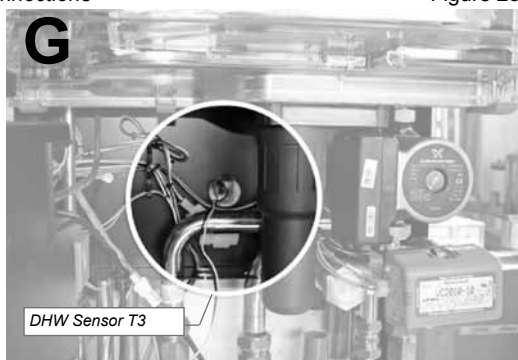
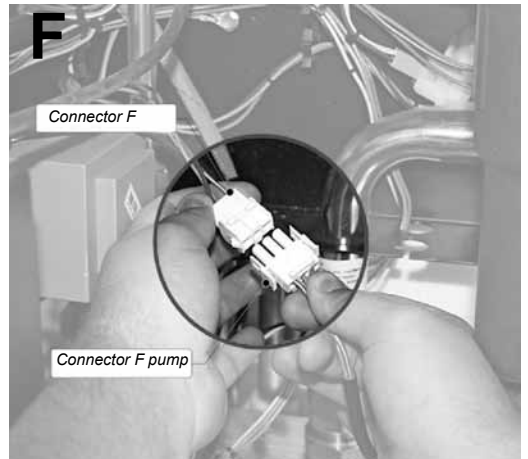
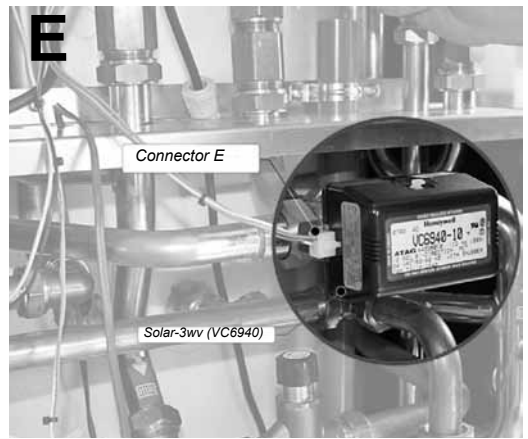
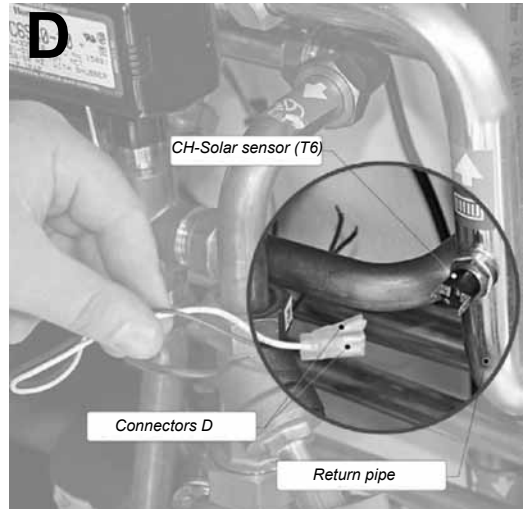

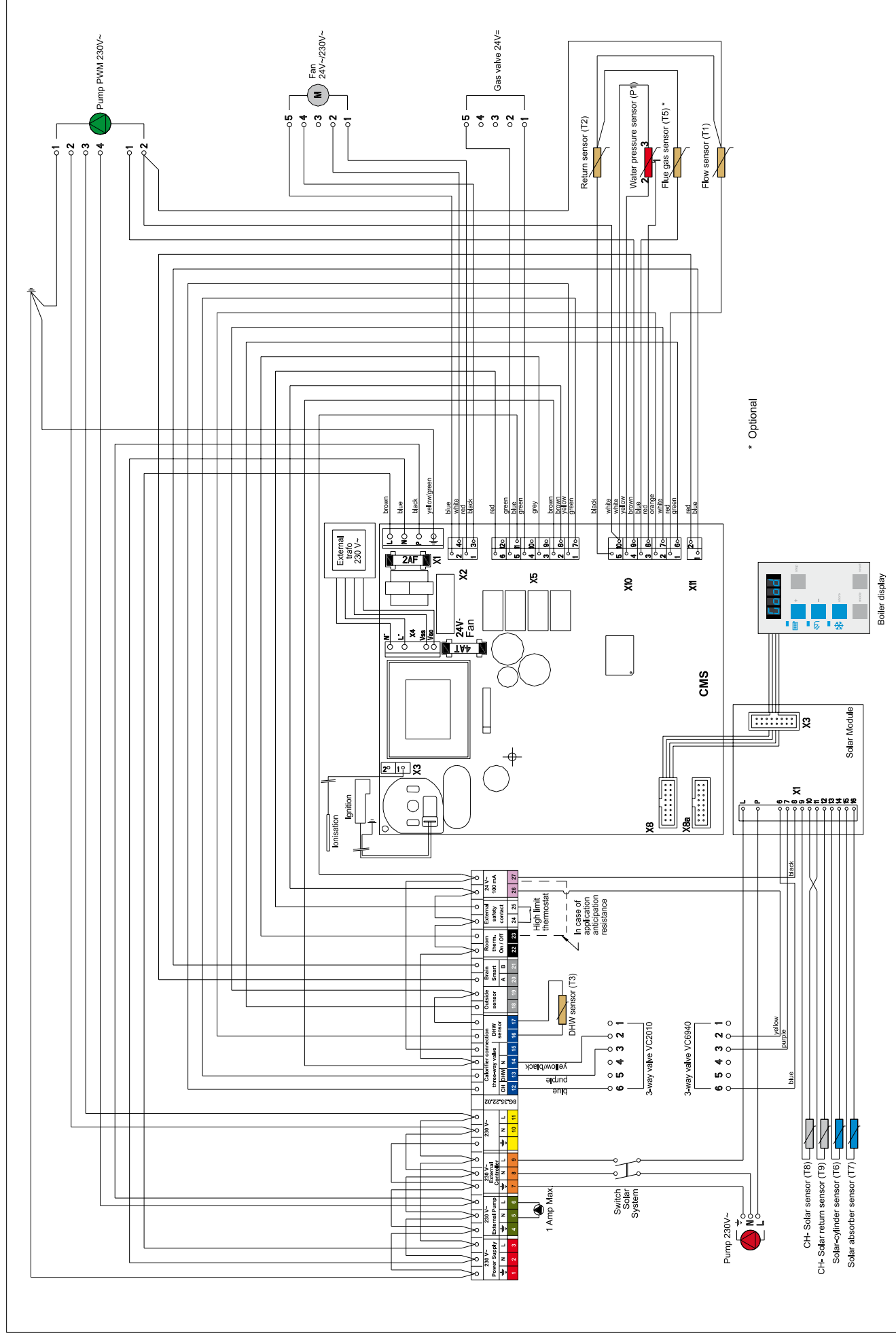

electrical diagram

figure 26

8.2 Outside sensor (optional)

Place the outside sensor on a north facing wall. The outside sensor should be placed in such a way, that sun, snow and/or air streams of ventilation do not have any adverse influence. Do not place the sensor on a chimney.

Connect the outside sensor with a 2-core cable of 0,75mm² on connection points 18 and 19 of the connection terminal in the Control Tower (see figure 13 and 16)

8.3 Solar absorber sensor

The ATAG Q-Solar boiler will **only** operate with the ATAG supplied panel sensor. This sensor is within the hardware box supplied with the Q-Solar boiler.



Do not fit any other panel sensor as it will not be compatible.

The PT100 absorber sensor T7 (green) is part of a kit comprising the PT100 Solar cylinder sensor T6 (red) and the Delta-T control in the Solar Module. The functioning of the Delta-T control is described in chapter 9.2 and 9.3.

Connect the absorber sensor according to chapter 8.1. The sensor cable can be lengthened to a maximum of 10 meters of 2 core cable of 0,75mm². If the sensor cable is lengthened with more than 10 meters of cable the sensor must be calibrated to get equal resistance values (see chapter 8.4)

8.4 Calibrating the sensors



Calibrating the sensors is only necessary when a sensor cable is lengthened to more than 10 meters of 0,75mm² cable.

On the Delta-T control (Solar module) are 2 PT100 sensors (cylinder T6 and absorber T7) connected.

When a sensor cable is lengthened to more than 10 meters a parameter adjustment has to be made. Please contact ATAG Heating for guidance.

The boiler is provided with a fully automatic microprocessor control, called CMS Control Management System. This control simplifies operation by undertaking all major control functions. Initially when power to the unit is switched on it will remain on standby. There is no indication Led on, until one of the programme keys is pressed. The control panel display will show the relevant state. When the installation is empty of water the display will show FILL.

The various parameters can be called up in two ways:

The Good-state or standard read out



The first way shows a simple display read out.

The boiler in operation will always show 'Good'. When a message is necessary this will be shown instead of Good.

Technical read out







The second way is a technical read out. In normal situations the following will be shown:

- on the left the status in which the boiler is active;
- on the right the flow temperature;
- the water pressure in the installation.

When a message (error or blocking code) is necessary this will be shown instead of the technical read out..



To switch over from the Good-state to the Technical read out (and vice versa):
- Press for 5 sec. on the STEP-key.

When the system has been filled the automatic venting program starts, when a programme has been selected, by pressing the key for Central Heating, DHW or pump programme (,  or ). The programme takes 17 minutes and stops automatically. After this the unit will function normally. (See also 'Filling and venting the boiler and installation).

On a call for heating or hot water the control system will select the required water control temperature. This water temperature is called the T-set value. On a call for central heating the boiler ignites first at low output. The output is then changed slowly to match the load required. The boiler operates in this way to avoid excessive water noises and temperature overshoot. On a call for hot water supply the T-set value of central heating return water temperature is monitored. Depending on the amount of sanitary water which is withdrawn from the DHW cylinder, the central heating return water temperature, from which the input is adjusted, will vary.

9.1 Explanation of the function keys



- Central Heating programme key.
Switching the Central Heating on or off (Led on/off);



- Hot Water programme key.
Switching the Domestic Hot Water (DHW) facility on or off (Led on/off);



- Pump programme key.
adjusts the pump to continuous water circulation in the central heating system (Led on), or according to the pump overrun times on the relevant programs (Led off);

When the pump is switched on continuously it can lead to undesired heating up of the central heating system during the summer.

- Mode-key.
*After briefly pressing, a selection of the data chapters can be retrieved.
After pressing for 5 seconds it is possible to enter the code as described in chapter 11.3;*
- Step-key.
*After briefly pressing, the water pressure can be retrieved and pages per chapter can be retrieved.
After pressing for 5 seconds it switches from the Good-state to technical read out and vice versa;*
- Reset-key.
After briefly pressing, for:
 - *unlocking errors;*
 - *ending the access code;**After pressing for 5 seconds an operating stop is made, for example, for activating the automatic venting programme.*

Some keys have other functions. These functions are only active when according to the procedure described in chapter 11.4, adjustment has to be changed or data must be retrieved from the CMS.

The other functions are:

- Central Heating programme key : **+** function.
- Hot Water programme key: **-** function.
- Pump programme key : **store-function**, which means that by means of this key a modified setting is confirmed.
- Step-key: **scrolling** in a data chapter.

9.2 Solar module

In the Control Tower, next to the CMS for the boiler, is the Solar Module [Delta-T controller] to control the solar circuit. This control is completely separate from the boiler control and can be switched off with the switch on the Control Tower.

9.3 Functioning of the Solar module

The Delta-T control of the Solar module functions in combination with 2 solar sensors. One is situated on the cylinder, the second one is situated in the absorber (follow the instructions of the supplier)

The inputs for the sensors have a temperature range of -40°C to $+175^{\circ}\text{C}$. The maximum temperature difference between cylinder and absorber amounts to -80°C to $+175^{\circ}\text{C}$. The Delta-T controller works on the basis of the measured temperature difference between the sensor in the cylinder and the absorber. The absorber pump is activated if the temperature in the absorber is approx. 10°C higher than the temperature in the cylinder. The absorber pump switches off automatically as soon as this temperature difference has dropped to approx. 2°C .

The pump also switches off automatically as soon as the cylinder has reached a temperature of 80°C . The controller allows the pump to restart once the temperature of the cylinder has dropped to 75°C .

When there is a heat demand on CH and the cylinder contains sufficient heat (solar) the modulating 3-way valve will pass to the CH circuit via the Solar CH coil in the cylinder. Sensor T8 and T9 will measure the temperature difference and together with the standard data from the CMS it decides if heat may be retrieved from the cylinder or that the boiler has to fire. DHW demand is always priority and if the cylinder contains insufficient heat due to insufficient solar influence, the boiler will operate.

Fill the following parts of the installation:

- cylinder (secondary DHW circuit)
- solar circuit (see page 21)
- central heating system (primary circuit)

10.1 Filling the cylinder (secondary DHW circuit)



Do not manually open the temperature and pressure relief valve or expansion relief valve for venting purposes (any foreign matter in the pipework may cause damage to the valve seats).

To fill the hot water cylinder:

- Open the isolation valve in the cold feed supply to the cylinder;
- Open all hot water outlet taps;
- Close the hot water taps as water runs freely out of each. This will remove any air within the cylinder and outlet pipework;
- Switch on the boilers DHW programme button.



To flush the cylinder:

- Allow the cylinder to fully heat up;
- Turn off the boilers hot water programme, and open all hot water outlet taps until the water runs cold. This will flush the cylinder and pipe work through.



To drain the cylinder:

The cylinder can be drained by means of the drain tap fitted.

- Close the cold feed supply isolation valve;
- Open all hot water outlet taps;
- Open the cylinders drain tap until water stops flowing.

10.2 Central heating system (primary circuit)



Do not use boiler pressure relief valve for venting purposes.

- The complete primary heating system must be flushed out with cold and hot water. Fill and vent the central heating system as detailed in the boiler installation instructions. Use only potable water.

For filling or topping up the installation you use the filling loop according to the following procedure:

- 1 Switch on the power supply;

FILL

- 2 The display will show FILL;



- 3 All functions off (heating, DHW and pump);



- 4 Push briefly the 'STEP'-button: P x.x = water pressure in bar;

- 5 Open the filling loop (Indication on display increases);

P 1.5 P 1.7

- 6 Fill up slowly to 1.5 to 1.7 bar;

STOP

- 7 STOP appears on the display;

- 8 Close the filling loop;

- 9 De-aerate the complete installation, start at the lowest point;

- 10 Check the water pressure and if necessary top it up;

- 11 Close the filling loop;



- 12 Activate the functions in use (heating , DHW  and/or pump 

- 13 If A xx appears on the display, wait for 17 minutes.

A XX

Do not press the Reset button as this restarts this process;



- 14 Check the water pressure and if necessary top it up to 1,5 to 1,7 bar

- 15 Close the filling loop;



- 16 Press the 'STEP'-button;

- 17 Be sure that the filling loop is closed.

Good 0 XX

- 18 After the automatic de-aeration programm (A xx) is finished the boiler will return to the Good state or Technical read out (xx = actual flow temperature).

P 1.5 P 1.7

Check the water pressure regularly and top up the installation when necessary. The working pressure of the installation should be between 1.5 and 1.7 bar when the installation is cold.



It can take a while before all air has disappeared from a filled installation. Especially in the first week noises may be heard which indicate the presence of air. The automatic air vent in the boiler will make this air disappear, which means the water pressure can reduce during this period and therefore topping up with water will have to be done.

11 Commissioning the boiler

Before the boiler is fired, ensure that the boiler and the system are well vented and free of air. Purge the gas line between the gas meter and the boiler and carry out a gas soundness test as specified in the current Gas Safety Installation & Use Regulations. The boiler does not require adjustment of the burner pressure and air quantity because it is self adjusting and is factory set at the correct value.

11.1 Central Heating system

Provided there is a heat requirement from the thermostat or control, the central heating programme will be put into operation by means of the  key (central heating programme). The circulation pump will start circulating and the boiler will start the burner.

11.2 Hot water supply

Provided there is a heat requirement from the cylinder, the hot water programme will be put into operation by means of the  key (hot water programme).

11.3 Solar circuit

Switch on the solar circuit by means of the (solar) switch on the Control Tower. When the temperature difference between absorber and cylinder $>10^{\circ}\text{C}$ the solar pump will switch on and will function according to the control of the Solar module described on page 28.

When the boiler has to be functioning without the connected solar circuit, the switch (solar) on the Control Tower should be switched off (0) and the flat cable should be removed from the Solar module. The Solar module (PCB) is situated on the back inside the Control Tower.

11.4 Adjustments

When the boiler is installed it is in principal ready for use. All adjustments of the boiler control are already pre-programmed for a heating system with radiators/convectors with a flow temperature of 85°C. The adjustments are described in the Parameter chapter on page 33.

In certain cases adjustment have to be altered in case of :

- Lower flow temperature

Read through the Parameter chapter to adjust the boiler to its installation. Contact ATAG Heating in case of doubt.

Please follow the next procedure to alter adjustments:

Altering adjustments

STEP 1 Press the Mode-key for 5 seconds.
The display shows CODE followed by an arbitrary number;

STEP 2 Press by means of the + or the - key until the code C123 is shown;

STEP 3 Press the STORE-key to confirm the code (code blinks 1 x).

Now you have access to the installer level. There are 4 chapters:

- PARA *Parameters*
- INFO *Information chapter (no adjustments possible)*
- SERV *Service chapter*
- ERRO *Error-chapter (no adjustments possible)*

The content of the chapters is described on the following pages.

STEP 4 Press briefly the MODE-key to select one of the 4 chapters, i.e. PARA;

STEP 5 Press briefly once or more on the STEP-key to select a Parameter
(parameter visible on the left, value on the right) ;

STEP 6 Alter the value, if necessary/possible, by means of the + or the - key

STEP 7 Press briefly on the STORE-key to confirm the alteration.
When you have to change more values, repeat from step 5.

STEP 8 Press once or more on the MODE-key until StBY or Good is shown:
After a few seconds the text StBY will be replaced by the technical read-out or Good-state (Depending from the position the access code is keyed in)

When you want to return from an arbitrary position to the original read out press once or more on the MODE-key until StBY is shown.



After 20 minutes if no single key is used, the display will return automatically to its original read-out (Good state or technical read out)

Parameter-Mode			
PARA	Factory	Description	Range
1	70°C	maximum flow temperature CH	20 - 85°C
2*	02	type of CH installation: <i>radiators; air heating; convectors:</i> <i>T max. flow 85°C; K factor heating line 2.3; gradient 5°C/min; gear</i> <i>radiators with large surface areas or underfloor heating as additional heating:</i> <i>T max. flow 70°C; K factor heating line 1.8; gradient 5°C/min; gear</i> <i>under floor heating with radiators as additional heating:</i> <i>T max. flow 60°C; K factor heating line 1.5; gradient 4°C/min; gear</i> <i>full under floor heating:</i> <i>T max. flow 50°C; K factor heating line 1.0; gradient 3°C/min; gear</i>	01 02 03 04
3	max.	maximum power CH in kW	min-max
4*	00	control principal with on / off thermostat: 100 % on / off thermostat 100 % on / off weather dependant	00 01
5*	2.3	heating line K-factor (see also heating line graph)	0.2 - 3.5
6*	1.4	heating line exponent (see also heating line graph)	1.1 - 1.4
7*	-10	heating line climate zone (see also heating line graph)	-20 - 0
10*	0°C	fine adjustment heating line day temperature	-5 to 5°C
11*	0°C	fine adjustment heating line night temperature	-5 to 5°C
14	5	gradient speed	0 - 15
15*	0	booster after night reduction: no yes	00 01
23	-3°C	Frost Temperature	-20 to 10°C
31	63°C	Cylinder temperature with external cylinder sensor	40 - 80°C
36	0	Type of three way valve cylinder VC 2010 / VC 8010 VC 6940	00 01
43	max.	Maximum power DHW in kW	min-max
45	0	No function	00 - 01
48	25% (50%)	Minimum pump capacity (Q60S)	25-100 %
49	100%	Maximum pump capacity Heating	40-100 %
89	00	Address of boiler in cascade No function ATAG Bus thermostat (BrainQ, MadQ, Smart) Cascade boiler 1 to 8	-01 00 00 - 07

Info-Mode		
INFO	Factory	Description
1	°C	flow water temperature T1
4	°C	return water temperature T2
5	°C	DHW temperature T3
7	°C	outside temperature T4
8	°C	flue gas temperature T5
16	%	actual power in %
17	kW	actual power in kW
18	kW	actual load in kW
20		indication bus communication
21	GJ	consumption total in GJ (.. x 33 = .. m3)
22	GJ	consumption CH in GJ (.. x 33 = .. m3)
23	GJ	consumption DHW in GJ (.. x 33 = .. m3)
24	Std	total number of burner run hours
25	Std	number of burner run hours CH
26	Std	number of burner run hours DHW
32	Std	total number of hours counter
37	Std	total number of run hours pump CH and DHW
46	Std	within how many hours is service required
200	°C	Solar-Cylinder - Temperature T6
201	°C	Solar-Absorber-Temperature T7
202	°C	Solar-Cylinder-Temperature Heating coil T8
203	°C	Solar-Cylinder-Return temperature Heating T9
204	h	Solar pump running hours
205	h	Total number of hours solar contribution to heating

Service-Mode			
SERV	Value	Description	Range
1	OFF	boiler in operation with burner function on	OFF - max.
2	OFF	fan adjustable and burner off	OFF - max.
3	OFF	pump adjustable with burner on	OFF - max.
4	OFF	showroom position ON = active and OFF = non active	ON - OFF
200	0	Solar pump Manual (1) / Automatic (0)	0 - 1
201	0	Three port valve solar-heating open (1) / closed (0)	0 - 1

Error-Mode		
ERRO	Value	Description
Err.L - Err.5		Last saved error until 5 last predecesing errors
1		error code
2		operation status boiler
3	°C	flow water temperature T1
4	°C	return water temperature T2
5	kW	load
6	%	pump capacity

Parameter-, Info-, Service- and Error-chapters

Table 9

* Most of the data in this table can be obtained by the BrainQ. Most of the adjustments which are stated in this table are unnecessary when in combination with the ATAG BrainQ thermostat and will be taken care of by the BrainQ itself and do not have to be adjusted. For further information regarding the BrainQ thermostat, please refer to the ATAG BrainQ installation manual.

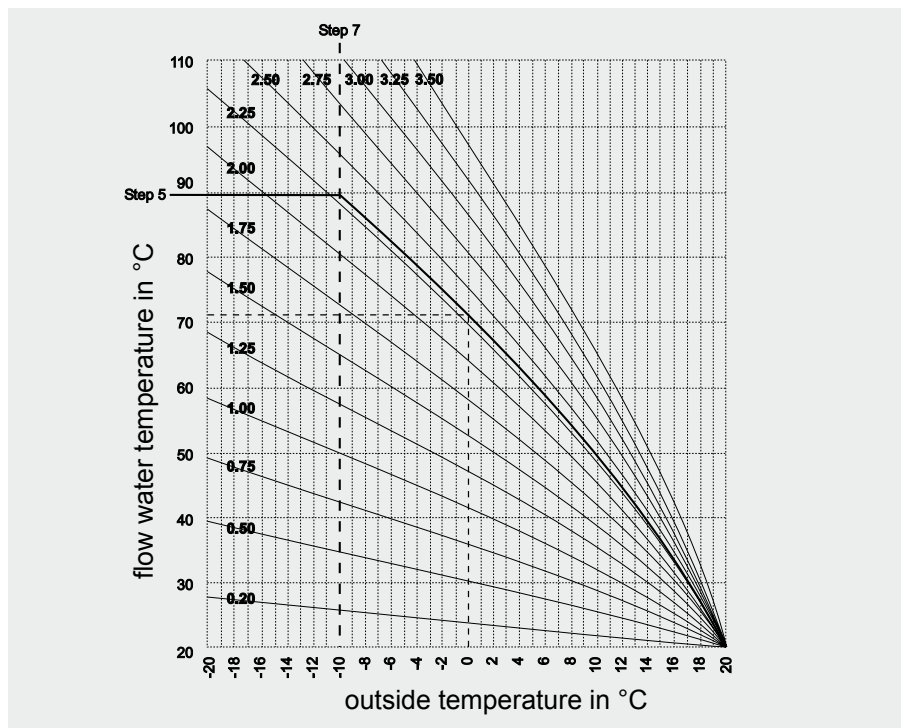

heating line adjustments Parameter Step 6 and 7



graph 2

11.5 Activating factory settings (green key function)

To activate the factory settings again please follow the next procedure (Note: all altered adjustments will be set back):

- Select, when necessary, the technical read out;
- Select with the MODE-key chapter PARA;
- Press the STORE-key.

The word "Copy" will appear and the factory settings are active again.

In some situations it may be that the entire boiler must be switched off. By switching off the three keys with the lamps for central heating, hot water and pump programme (,  or ), the boiler is switched off. Leave the plug in the wall socket, which means the circulation pump and the three-way valve are activated once every 24 hours in order to prevent jamming.



In the event of frost danger it is advisable to drain the boiler and/or the installation.

Alternatively you can drain the central heating system, boiler and cylinder. Please contact your Installer. The cylinder can be drained almost completely (> 80%) using the drain valve at the bottom of the cylinder .



Work on the installation should only be carried out by qualified personnel with calibrated equipment.



At the time of commissioning, complete all relevant sections of the Benchmark Checklist located on the inside back pages of the document.

To commission the boiler the casing has to be removed. The casing is locked with a screw behind the door on the front, and the top of the casing is hooked behind a locking edge. After removing this screw the casing must be lifted at the bottom by which means it is released from the locking edge. Then the casing can be removed forward.

Changing settings, such as the burner pressure and the amount of air flow, is superfluous. Only in case of a failure or when replacing the gas block, venturi and/or fan, the CO₂/O₂ percentage should be checked.



Always check all gas carrying parts for leaks (with a leak detection spray) after (maintenance) work to the boiler.

13.1 Checking for contamination

In order to be able to check the boiler for contamination in the following years it is advisable to measure the maximum air displacement in the boiler when putting the boiler into operation. This value can be different with each type of boiler.

In order to be able to measure this value follow the next procedure:



- Press the MODE-key for 5 seconds.



- The display will show COdE followed by an arbitrary number;



- Select by means of the + or the - key the code C123;



- Press the Store-key to confirm the code (code blinks 1 x);



- Press the MODE-key until SERV is shown;



- Press the STEP-key until 2 is shown; alternately 2 and OFF will be shown.

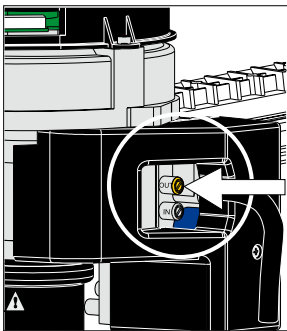

Test nipple

figure 27

- Undo the top test nipple on the gas valve (fig. 27);
- Connect the hose of the digital pressure gauge to the top test nipple of the gas valve
- Press the + key until the maximum value is achieved; The fan will function to its maximum revolutions (burner stays off)
- Measure the under pressure and write down this value. At the next service visit this value may drop by 20% of its original value recorded on commissioning. If this value has dropped by more than 20% the boiler requires full maintenance.



- Press the - key until OFF is shown (keep key pressed) With this the procedure is finished.

13.2 Checking the CO₂/O₂



The CO₂/O₂ percentage is factory-set. This has to be checked at commissioning, maintenance and faults.

This can be checked by means of the following procedure:

- Remove the black cover of the gas valve by unscrewing the sealed screw.
- Put the boiler into operation and take care that it can deliver its heat;



Tip: If there is no demand for heat on CH, turn the hot water tap completely open and measure the CO₂/O₂.



- Press the MODE-key for 5 seconds.



- The display will show COdE followed by an arbitrary number;



- Select by means of the + or the - key the code C123;



- Press the Store-key to confirm the code (code blinks 1 x);



- Press the MODE-key until SERV is shown;



- Press the STEP-key once until 1 is shown; alternately 1 and OFF will be shown.

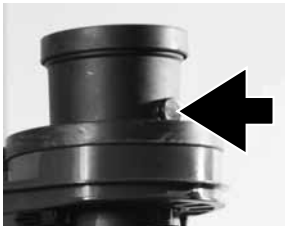

checkpoint CO₂/O₂ figure 28

- Calibrate the CO₂/O₂ meter ;
- Place the lance of the CO₂/O₂ meter into the check point (see fig. 28);
- Press the + key until the maximum value (in kW) is achieved;
The boiler will burn on full load (value on display in kW)

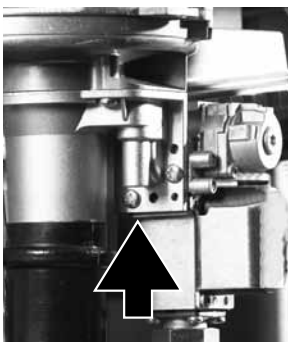

adjustment screw CO₂/O₂ figure 29

- CO₂ percentage = 9%
O₂ percentage = 4,7%
- Let the CO₂/O₂ meter do its measuring procedure.
- Adjust, if necessary, the adjustment screw to correct the CO₂/O₂ value (see fig. 29).



Ending the CO₂/O₂ measuring procedure:

- Press the - key until OFF is shown (keep key pressed).
With this the procedure has ended..
- Replace the black cover on the gas valve and fix it with the screw.

13.3 Maintenance activities

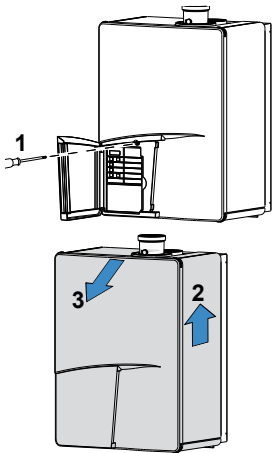

Removing casing figure 30

To carry out the maintenance activities please follow the next procedure:

- switch off the power supply;
- remove the screw behind the door on the front of the casing (see fig. 30);
- Lift the casing and remove it towards the front.

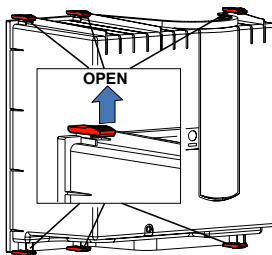

Opening air box figure 31

The air box

- remove the transparent air box (see fig. 31);
- clean the box with a cloth with a simple (non-abrasive) cleaning agent;

The fan unit and burner cassette (see fig. 32 and 33)

- remove the electrical connection plug from the gas valve (1) and fan motor (2);
- loosen the nut (3) of the gas pipe under the gas valve;
- **replace the gasket with a new one;**
- loosen the front cross head screw (4) of the black plastic silencer;
- after this turn the two clamping rods (9 and 10) $\frac{1}{4}$ turn and remove them by pulling them forward. **Note the correct turning direction (red indicator, fig. 23);**
- slightly lift the fan unit and remove it towards the front of the heat exchanger;
- remove the burner cassette out of the fan unit;
- check the burner cassette for wear, pollution and possible cracks. Clean the burner cassette with a soft brush and vacuum cleaner.

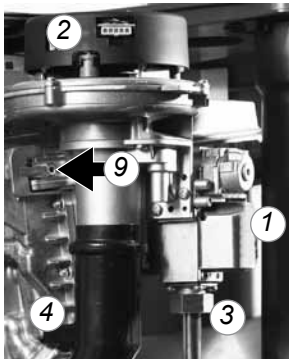

fan unit and gas valve figure 32

If burners are cracked replace the complete burner cassette;

- **replace the gaskets between burner and fan unit and the gasket between fan unit and heat exchanger;**
- check the venturi and the gas-air distribution plate for pollution and clean this part, if necessary with a soft brush and vacuum cleaner. If the air box contains a lot of dirt it is plausible that the fan itself is dirty as well. To clean this, the fan has to be removed from the hood and the venturi. Clean the fan with a soft brush and a vacuum cleaner. Replace the gasket and ensure that all gaskets of the fan parts are mounted correctly.

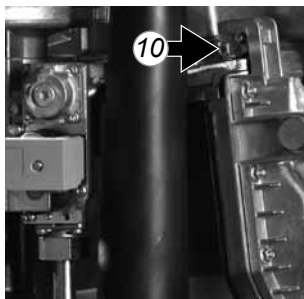
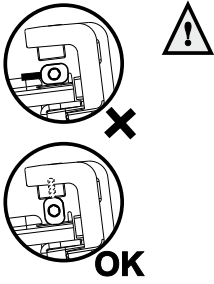

figure 33

Heat exchanger

- check the heat exchanger for contamination. Clean this if necessary with a soft brush and a vacuum cleaner. Prevent dirt falling down into the heat exchanger. **Flushing the heat exchanger from the top down is not permitted**

Refitting of the components is done in reverse order.



Make sure that during refitting of the clamping rods, they are put into the correct position. They should be turned vertically.

Ignition electrode

The replacement of the electrode is only necessary when the electrode is worn off. This can be checked by measuring the ionisation current. The minimum ionisation current has to be higher the 4µA on full load.

If the viewing glass is damaged the complete electrode must be replaced.

Replacement goes as follows:

- remove the electrical connections of the electrode;
- press the clips on both sides of the electrode to both sides and remove the complete electrode;
- remove and replace the gasket;

Refitting of the components is done in reverse order.

Siphon and condensate tray (see fig. 34 and 35)

Step 1: Siphon

- first remove the condensate cup (7);
Check this for pollution. If there is no sign of strong pollution it is not necessary to clean the condensate tray (Go to Step 3). If there is strong pollution in the cup it is necessary to remove and clean the condensate tray according Step 2;
- remove the inner siphon pipe (8) which remains in the condensate tray;
- check the O-rings of the cup as well as those from the pipe and replace if necessary;
- clean both parts by flushing it with clean water;
- grease the O-rings again with acid free O-ring grease to make fitting easier;
- if there is a leak at the condensate cup (7) or tray (9) the complete condensate trap unit (10) has to be replaced by S4451610;

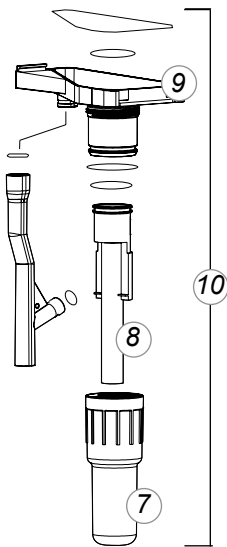

Siphon figure 34

Step 2: Condensate tray

- remove the plug from the flue gas sensor if present;
- turn the two short clamping rods (11 and 12) ¼ turn and remove them by pulling them forward; **Note the correct turning direction (red indicator, fig. 25);**
- lift the exhaust pipe (13) out of the condensate tray (14);
- press the condensate tray (14) carefully downwards and remove it by pulling it forward;
- replace the gasket between condensate tray and heat exchanger by a new one;
- clean the condensate tray with water and a hard brush;
- check the condensate tray on leaks.

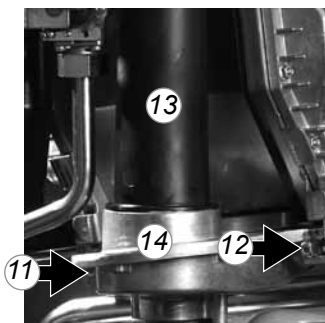

Condensate tray figure 35

Step 3: Refitting is done in reverse order.

Note that all gaskets seals completely.

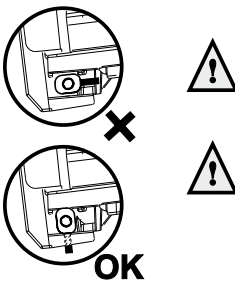

Make sure that during refitting the clamping rods they are put in the right position. They should be turned vertical.

Always replace all removed gaskets of dismantled parts during the maintenance activities.

Put the boiler into operation and check the CO₂/O₂ (see page 40).

Cylinder

The casing of the cylinder may be cleaned with a damp cloth and a little soap. Do not use any abrasive or solvent material which could damage the case or fittings.

The following maintenance work has to be carried out by the competent installer.

- Inspection of pressure/temperature relief valve and expansion relief valve. Manually operate each valve by twisting the operating cap, and check if water flows unobstructed via the tundish to the discharge point. ensure that both valves re-seat satisfactorily.
- Check pressure of expansion vessel.
Turn off mains water supply and open nearest hot water tap to depressurise the secondary water system.
Check the expansion vessel charge pressure gauge at the test point. If the pressure is below 3.0 bar, top up with suitable air pressure pump.
- Complete service section of cylinder commissioning checklist.



In the event that parts require replacement, use only genuine parts supplied by ATAG Heating UK Ltd.

Please contact your installer or ATAG Heating UK Ltd. for further details. Contact details can be found on the back page of this manual.



After servicing, complete the relevant Service Interval Record section of the Benchmark Checklist located on the inside back page of the document.

13.4 Draining the installation

During servicing one of the following items has to be drained:

1. Central heating system - boiler

The central heating system and boiler can be drained using the fill- and drain valve installed in the system. If service valves are installed (advised) the boiler can be drained separately from the rest of the installation via the drain valves on the service valves.

2. Cylinder

The cylinder can be drained almost completely (> 80%) using the drain valve at the bottom of the cylinder behind the bottom part of the casing.

3. Solar system

Refer to the instructions of the supplier of the absorber to drain the solar system.

13.5 User's instructions

Hand these instructions and the user manual to the user for retention and instruct in the safe operation of the boiler and cylinder. Advise the user of the operation of the cylinder temperature, and that normally a setting of max. which gives a stored water temperature of approximately 60°C is adequate.



In hard water areas the DHW temperature setting should not exceed this setting to avoid possible scale build-up.

Frost protection

Advise the user of the precautions necessary to prevent damage to the system and to the building if the system does not remain operative during frost conditions.

Please ensure that if you are absent during a period of frost the central heating system remains in operation and the rooms and CBS cylinder are kept above freezing point.

Finally, advise the user that for continued efficient and safe operation, the boiler and cylinder should be serviced at least once a year by qualified servicing company. It is important and strongly recommended that arrangements are made for a maintenance agreement with a qualified servicing company to ensure regular servicing of the boiler and cylinder.

Please contact ATAG Heating UK Ltd. for further details. Contact details can be found on the back page of this manual.

13.6 Maintenance frequency

ATAG Heating UK Ltd advises an annual inspection, with a full strip down service every 4 years, depending on the operational hours listed in the warranty conditions.

13.7 Warranty

For the warranty conditions we refer to the Warranty Card that is supplied with the boiler.

14 Technical specifications

Boiler type		Q-Solar			
		200 litre		380 Litre	
		Q25SC200N	Q38SC200N	Q25SC380N	Q38SC380N
Input Hs CH	kW	25	38	25	38
Qn Input Hi CH	kW	22,5	34,2	22,5	34,2
Qnw Input Hi DHW		22,5	34,2	22,5	34,2
Efficiency class according BED	%	★★★★	★★★★	★★★★	★★★★
Efficiency according EN677 (36/30°C part load, Hi)	%	109,8	109,6	109,8	109,6
Efficiency according EN677 (80/60°C full load, Hi)	%	97,5	97,4	97,5	97,4
Modulation range CH (capacity 80/60°C)	kW	4.4 - 21.9	6.0 - 33.3	4.4 - 21.9	6.0 - 33.3
Modulation range CH (capacity 50/30°C)	kW	4.9 - 23.9	6.8 - 36.3	4.9 - 23.9	6.8 - 36.3
Nox class EN483		5			
CO ₂ /O ₂	%	9 / 4,7			
Flue gas temp. CH (80/60°C on full load)	°C	68	69	68	69
Flue gas temp. CH (50/30°C on low load)	°C	31			
Gas consumption G20 CH (DHW) (at 1013 mbar/15°C)	m ³ /h	2,38	3,62	2,38	3,62
Electr. power consumption max.	W	106	165	106	165
Electr. power consumption on part load acc. EN677 incl. boiler pump	W	74	74	74	74
Electr. power consumption stand by	W	10			
Current	V/Hz	230/50			
Fuse rating	A	5			
Degree of protection acc. EN 60529		IPX0D			
Weight boiler (empty/filled)	kg	50 / 53,5	53 / 58	50 / 53,5	53 / 58
Weight cylinder (empty/filled)	kg	75 / 275	75 / 275	98 / 478	98 / 478
Weight total (empty/filled)	kg	125 / 328,5	128 / 333	148 / 531,5	151 / 536
Width	mm	510	510	660	660
Height	mm	1880	1880	1860	1860
Depth	mm	895	895	1040	1040
Water content CH	l	3,5	5	3,5	5
Water content DHW	l	200	200	380	380
Water content DHW effective	l	80	80	150	150
Water content Solar part	l	120	120	230	230
Input Solar part (80/30°C)	kW	8	8	10	10
After run time pump CH	min	5			
After run time pump DHW	min	1			
P _{MS} Water pressure min./max.	bar	1 / 3			
P Operating water pressure / nominal	bar	1 / 3.5			
DHW flow (at 38°C)	l/min	24,1	29,5	30,9	38,9
DHW flow (at 60°C)	l/min	13,5	16,5	17,3	21,8
DHW temperature (T _{in} =10°C)	°C	60			
Heat up time 15° to 60°C (gas fired)	min	17		19	
Reheat time (70% draw off)	min	12		18	
DHW Expansion vessel charge pressure	bar	3			
DHW Expansion valve setting	bar	6			
Pressure reducing valve	bar	3,5			
Set opening temperature and pressure of relief valves	K, bar	95 / 7,0			
Pump type boiler	UPER	20-60	20-70	20-60	20-70
Available pump height CH	kPa	32	16	32	16
Pump type solar system		UPR15-60	UPR15-60	UPR15-60	UPR15-60
CE product identification number(PIN)		0063BQ3021			
Manufacturer		ATAG Verwarming Nederland BV Galileïstraat 27 NL 7131 PE Lichtenvoorde			

Installation & Servicing Instructions ATAG Q-Solar

15 Parts of the boiler

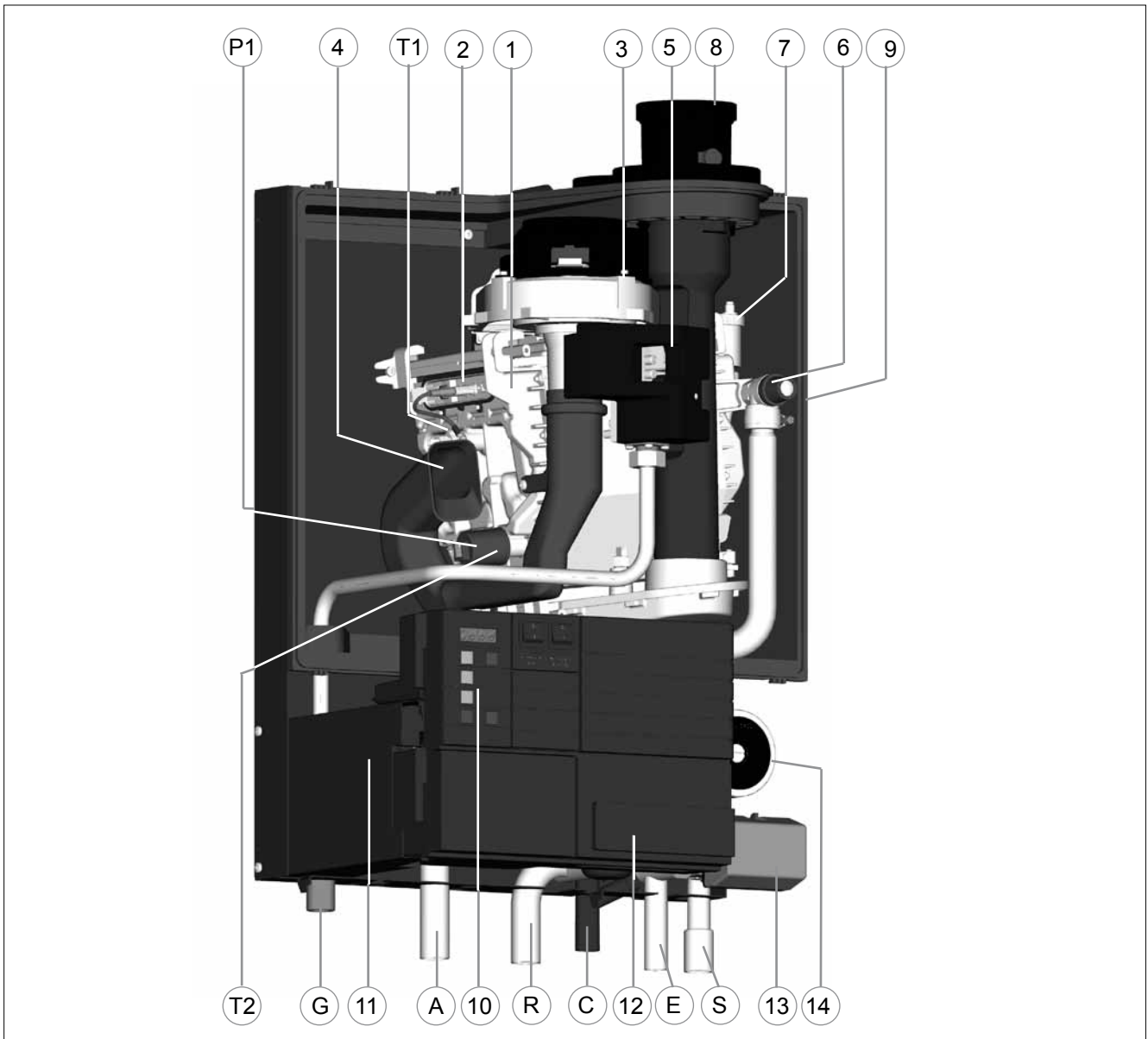

ATAG Q

figure 36

1 heat exchanger	10 operating panel	19 Solar pump
2 ignition unit	11 type plate	20 Relief valve solar circuit\
3 fan unit	12 Control Tower (CMS)	21 Drain valve cylinder
4 air inlet damper	13 three-way valve	22 Fill- and drain valve solar circuit
5 gas valve	14 circulation pump	23 Flow restriction
6 safety valve	15 Modulating 3-way valve (Solar-CH)	24 Single check valve DHW
7 automatic air vent	16 Safety group	25 Temperature and pressure relief valve
8 ceramic burner cassette	17 thermostatic mixing valve	26 High limit thermostat
9 air box	18 Expansion vessel Solar circuit	

G gas pipe
A flow connection central heating
R return connection central heating
C condensate pipe
E expansion vessel pipe
K cold water pipe
W hot water pipe
S Cylinder return pipe
U Flow pipe absorber
I Return pipe absorber
Z DHW Circulation line connection

T1 flow sensor
T2 return sensor
T3 cylinder sensor DHW (combi)
T4 Outside sensor (optional)
T5 Flue gas sensor (optional)
T6 Cylinder sensor Solar (DT)
T7 Absorber sensor Solar (DT)
T8 CH-Solar sensor
T9 CH-Solar return sensor
P1 water pressure sensor

See also page 41

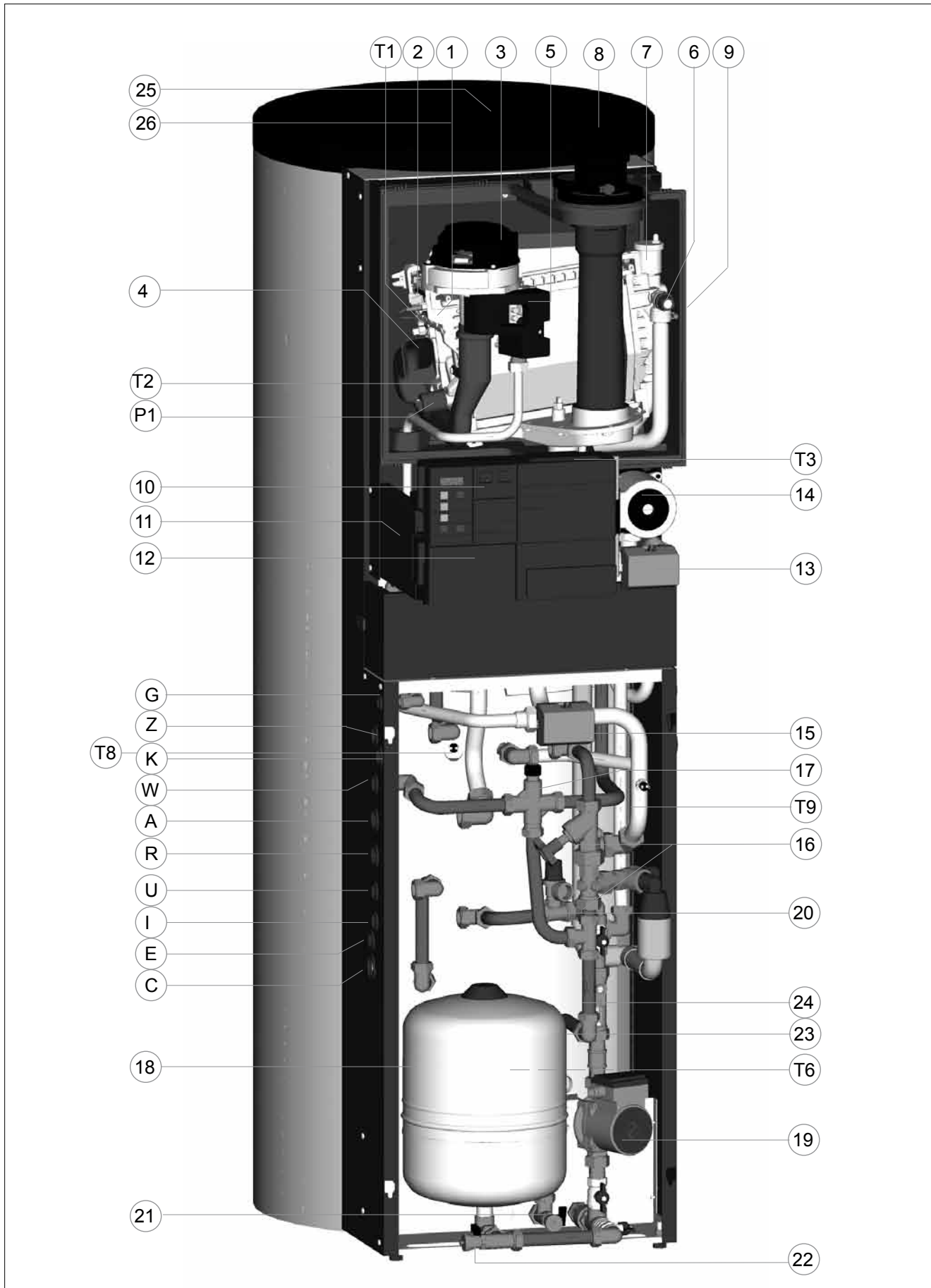

ATAG Q-Solar Q38SC380N

figure 37

16 Error message

If an error is detected it is indicated on the display by means of blocking or error messages. A distinction should be made between these two messages due to the fact that blocking can be of a temporary nature, however, error messages are fixed lockings. The control will try its utmost to prevent locking and will temporarily switch off the unit by blocking it. Hereunder is a list of some messages.

Blocks **bL** with a number in the last 2 positions.

- bL01** Block 01:
External safety contact cut off
- bL11** Block 11:
Maximum ΔT of flow and return sensor in central heating has repeatedly been exceeded. During the block normal operation of the hot water supply is possible. The pump continues to operate at minimum capacity during the block.
- bL12** Block 12:
Maximum ΔT of flow and return sensor in domestic hot water has repeatedly been exceeded. During the block normal operation of the central heating installation is possible. During the block the pump continues to operate at minimum capacity.
- bL18** Block 18:
Wiring T3 and T9 swapped
- bL60** Block 60:
Incorrect parameter setting of the minimum or maximum power.
- bL67** Block 67:
A ΔT has been detected between flow and return sensor whereas the burner is not in operation. After the ΔT has disappeared the block will disappear.
- bL80** Block 80:
Maximum flue gas temperature has been exceeded (if present). The block will not be cancelled until the flue gas temperature has arrived below the temperature.
- bL81** Block 81:
The flue gas sensor is not connected although it was connected to the control. The burner is blocked until the flue gas sensor is reconnected.
- bL82** Block 82:
The flue gas sensor has short-circuited, heat requirement blocked and pump capacity at minimum.
- bL85** Block 85:
The control has not detected a water flow. The venting cycle is started. If during this cycle water flow is detected, the venting cycle is ended and the burner is released.
- bL88** Block 88 and 89:
bL89 CH-Solar sensor (T8) open (88) or closed (89); boiler will functioning normally without solar circuit.
- bL90** Block 90 and 91:
bL91 CH-Solar return ensor (T9) open (90) or closed (91); boiler will functioning normally without solar circuit.
- bL92** Block 92 and 93:
bL93 Cylinder sensor (T6) open (92) or closed (93); boiler will functioning normally without solar circuit.
- bL94** Block 94 and 95:
bL95 Absorber sensor (T7) open (94) or closed (95); boiler will functioning normally without solar circuit.
- bL97** Block 97:
T1 - T6 too high; boiler will functioning normally without solar circuit.
- bL98** Block 98:
T6 > T6 maximum

Error **E** with a number in the last two positions.

- E 00** Error 00: Poor flame-forming
- E 01** Error 01: short-circuit of 24 volt circuit
- E 02** Error 02: no flame-forming
- E 04** Error 04: adjustment or error for voltage interruption
- E 05** Error 05: error MCBA
- E 19** Error 19: maximum return temperature exceeded
- E 28** Error 28: number of revolutions not reported back from fan
- E 92** Error 92: loose connection on terminal block PT100 sensors
- E 94** Error 94: loose connection on terminal block PT100 sensors

CE DECLARATION OF CONFORMITY

Hereby declares ATAG Verwarming Nederland BV that,

the condensing boiler types: ATAG

Q25SC200N	Q25SC380N
Q38SC200N	Q38SC380N

are in conformity with the provisions of the following EC Directives, including all amendments, and with national legislation implementing these directives:

<u>Directive</u>		<u>Used standards</u>
Gas Appliance Directive	2009/142/EC (ex.90/396/EEG)	EN483: 1999,A2 ;2001-C1 ;2006,A4 ;2007 EN50165: 1997
Efficiency Directive	92/42/EEC	EN677: 1998
Low Voltage Directive	2006/95/EG	EN50165: 1997 EN60335-1: 1994
EMC Directive	2004/108//EG	EN61000-3-2: 2000,A1 ;2001,A2 ;2005 EN61000-3-3: 1995,2006 EN55014-1: 1993;A1;2001,A2;2002 EN50165: 1997,A1;2001 EN55014-2: 1997,A1;2001

Report numbers

	GAD	ED	LVD	EMC D
ATAG Q	177021	177021	177021	178195-EMC

and that the products are in conformity with EC type-examination certificate number E0430, as stated by KIWA-Gastec Certification BV, Apeldoorn, The Netherlands.

Date :2-11-2010

Signature :



Full name : C. Berlo
CEO

ATAG
Verwarming

Adres: Galileïstraat 27, 7131 PE Lichtenvoorde • Postadres: Postbus 105, 7130 AC Lichtenvoorde
Telefoon: +31(0) 544 391777, Fax: +31(0) 544 391703
E-mail: info@atagverwarming.com Internet: http://www.atagverwarming.nl

GAS BOILER SYSTEM COMMISSIONING CHECKLIST

This Commissioning Checklist is to be completed in full by the competent person who commissioned the boiler as a means of demonstrating compliance with the appropriate Building Regulations and then handed to the customer to keep for future reference.

Failure to install and commission according to the manufacturer's instructions and complete this Benchmark Commissioning Checklist will invalidate the warranty. This does not affect the customer's statutory rights.

Customer Name _____ Telephone Number _____
 Address _____
 Boiler Make and Model _____
 Boiler Serial Number _____
 Commissioned by (print name) _____ Gas Safe Register Number _____
 Company Name _____ Telephone Number _____
 Company Address _____
 Commissioning Date _____

To be completed by the customer on receipt of a Building Regulations Compliance Certificate*:

Building Regulations Notification Number (if applicable) _____

CONTROLS Tick the appropriate boxes

Time and Temperature Control to Heating	Room Thermostat and Programmer/Timer <input type="checkbox"/>	Programmable Room Thermostat <input type="checkbox"/>	Load/Weather Compensation <input type="checkbox"/>	Optimum Start Control <input type="checkbox"/>
Time and Temperature Control to Hot Water	Cylinder Thermostat and Programmer/Timer <input type="checkbox"/>		Combination Boiler <input type="checkbox"/>	
Heating Zone Valves	Fitted <input type="checkbox"/>		Not Required <input type="checkbox"/>	
Hot Water Zone Valves	Fitted <input type="checkbox"/>		Not Required <input type="checkbox"/>	
Thermostatic Radiator Valves	Fitted <input type="checkbox"/>		Not Required <input type="checkbox"/>	
Automatic Bypass to System	Fitted <input type="checkbox"/>		Not Required <input type="checkbox"/>	
Boiler Interlock				Provided <input type="checkbox"/>

ALL SYSTEMS

The system has been flushed and cleaned in accordance with BS7593 and boiler manufacturer's instructions Yes
 What system cleaner was used? _____
 What inhibitor was used? _____ Quantity litres

CENTRAL HEATING MODE Measure and Record:

Gas Rate m³/hr OR ft³/hr
 Burner Operating Pressure (if applicable) mbar OR Gas Inlet Pressure mbar
 Central Heating Flow Temperature °C
 Central Heating Return Temperature °C

COMBINATION BOILERS ONLY

Is the installation in a hard water area (above 200ppm)? Yes No
 If yes, and if required by the manufacturer, has a water scale reducer been fitted? Yes No
 What type of scale reducer has been fitted? _____

DOMESTIC HOT WATER MODE Measure and Record:

Gas Rate m³/hr OR ft³/hr
 Burner Operating Pressure (at maximum rate) mbar OR Gas Inlet Pressure (at maximum rate) mbar
 Cold Water Inlet Temperature °C
 Hot water has been checked at all outlets Yes Temperature °C
 Water Flow Rate l/min

CONDENSING BOILERS ONLY

The condensate drain has been installed in accordance with the manufacturer's instructions and/or BS5546/BS6798 Yes
 If the condensate pipe terminates externally has the pipe diameter been increased and weatherproof insulation fitted? Yes

ALL INSTALLATIONS

If required by the manufacturer, record the following CO₂ % OR CO ppm OR CO/CO₂ Ratio
 The heating and hot water system complies with the appropriate Building Regulations Yes
 The boiler and associated products have been installed and commissioned in accordance with the manufacturer's instructions Yes
 The operation of the boiler and system controls have been demonstrated to and understood by the customer Yes
 The manufacturer's literature, including Benchmark Checklist and Service Record, has been explained and left with the customer Yes

Commissioning Engineer's Signature _____
 Customer's Signature _____
 (To confirm satisfactory demonstration and receipt of manufacturer's literature)

*All installations in England and Wales must be notified to Local Authority Building Control (LABC) either directly or through a Competent Persons Scheme. A Building Regulations Compliance Certificate will then be issued to the customer.



Service Record

It is recommended that your heating system is serviced regularly and that the appropriate Service Interval Record is completed.

Service Provider

Before completing the appropriate Service Record below, please ensure you have carried out the service as described in the manufacturer's instructions.

Always use the manufacturer's specified spare part when replacing controls.

Service 1

Date: _____

Engineer Name: _____

Company Name: _____

Telephone No. _____

Gas Safe Register No. _____

Comments: _____

Signature: _____

Service 2

Date: _____

Engineer Name: _____

Company Name: _____

Telephone No. _____

Gas Safe Register No. _____

Comments: _____

Signature: _____

Service 3

Date: _____

Engineer Name: _____

Company Name: _____

Telephone No. _____

Gas Safe Register No. _____

Comments: _____

Signature: _____

Service 4

Date: _____

Engineer Name: _____

Company Name: _____

Telephone No. _____

Gas Safe Register No. _____

Comments: _____

Signature: _____

Service 5

Date: _____

Engineer Name: _____

Company Name: _____

Telephone No. _____

Gas Safe Register No. _____

Comments: _____

Signature: _____

Service 6

Date: _____

Engineer Name: _____

Company Name: _____

Telephone No. _____

Operative ID No. _____

Comments: _____

Signature: _____

Service 7

Date: _____

Engineer Name: _____

Company Name: _____

Telephone No. _____

Gas Safe Register No. _____

Comments: _____

Signature: _____

Service 8

Date: _____

Engineer Name: _____

Company Name: _____

Telephone No. _____

Gas Safe Register No. _____

Comments: _____

Signature: _____

Service 9

Date: _____

Engineer Name: _____

Company Name: _____

Telephone No. _____

Gas Safe Register No. _____

Comments: _____

Signature: _____

Service 10

Date: _____

Engineer Name: _____

Company Name: _____

Telephone No. _____

Gas Safe Register No. _____

Comments: _____

Signature: _____



kiwa
approved
product



UK WATER SUPPLY
REGULATIONS



ATAG Heating UK Ltd. • Unit 3 • Beaver Trade Park • Quarry Lane Chichester West Sussex PO19 8NY
Phone: 01243 815 770 • Fax 01243 839 596 • E-mail: info@atagheating.co.uk • Internet: www.atagheating.co.uk

This renewed publication cancels all previous installation instructions. The company reserves the right to change the specifications and dimensions without prior notice.

E. & O. F.