



Installation and servicing instructions
MODEL **DIA** SYSTEM 27 RFFI
Type C
with Sealed Combustion Chamber
G.C. NUMBER

Produced by Merloni Termo Sanitari^{spa} - Italy

**LEAVE THESE INSTRUCTIONS
ADJACENT TO THE GAS METER**

MTS (GB) LIMITED
MTS Building, Hughenden Avenue, High Wycombe
Bucks HP 13 5FT
Telephone (01494) 459711 - Fax (01494) 459775

TABLE OF CONTENTS

Sect.	Subject	Page No.	Sect.	Subject	Page No.
1	GENERAL INFORMATION		6.13	Burner and injectors	25
1.1	Overall view	2	6.14	Insulations panels	26
1.2	Technical data	3	6.15	Gas modulator cartridge	26
1.3	Available pump head	4	6.16	Gas modulator coil	27
1.4	Flue pipes optional extras	4	6.17	On-off operator coils	27
1.5	Design principles and operating sequence	4	6.18	Gas valve	27
			6.19	Removing the fan	27
2	GENERAL REQUIREMENTS		6.20	Air pressure switch	28
2.1	Related documents	6	6.21	Main heat exchanger	28
2.2	Location of appliance	6	6.22	Automatic air purger	29
2.3	Flue system	6	6.23	Pump	29
2.4	Gas supply	6	6.24	Pump pressure switch	30
2.5	Air supply	7	6.25	Temperature pressure gauge	30
2.6	Water circulation	7	6.26	Expansion vessel	31
2.7	Domestic water	8	6.27	Safety valve	31
2.8	Electrical supply	8	7	ELECTRIC DIAGRAMS	
3	INSTALLATION		7.1	Electrical connection	32
3.1	Delivery	9	7.2	Functional flow connection	33
3.2	Measurements for installing the appliance	9	8	SHORT SPARE PARTS LIST	34
3.3	Unpacking the boiler	10	.	Control panel	
3.4	Positioning of the boiler	10	.	Residual head of circulator	
3.5	Mounting the flue exhaust pipes	11	.	Regulating heating power for Natural Gas (G20)	
3.6	Flue terminal guard	13	.	Regulating heating power for Butane Gas (G30)	
3.7	Electrical connections	13	.	Regulating heating power for Propane Gas (G31)	
4	COMMISSIONING				
4.1	Electrical installation	15			
4.2	Gas supply installation	15			
4.3	Filling the d.h.w. system	15			
4.4	Initial filling of the system	15			
4.5	Setting the system pressure	16			
4.6	Lighting the boiler	16			
5	MAINTENANCE				
5.1	General	17			
5.2	Recommended routine maintenance	17			
6	SERVICING INSTRUCTIONS				
6.1	Replacement of parts	18			
6.2	To gain general access	18			
6.3	To drain the main circuit of the boiler	19			
6.4	Setting gas pressure	19			
6.5	Overheat thermostat	21			
6.6	Removing ignition electrodes	21			
6.7	Removing flame sensor	22			
6.8	Replacing P.C.B.	23			
6.9	Replace the hot water temperature probe	24			
6.10	Removing c.h.w. sensor probe	24			
6.11	Diverter valve (motorized)	24			
6.12	Main flow switch	24			

*Dear customer,
Thank you for choosing a ARISTON combination boiler.
We guarantee that your boiler is a reliable and technically sound product.
This Owner's manual provides detailed instructions and recommendations for proper installation, use and maintenance.
Remember to keep this manual in a safe place for future reference i.e. by the gas meter.
Your local MTS Servicing Centre is at your complete disposal for all your requirements.*

MTS (GB) LIMITED



GUARANTEE

The guarantee on this appliance is valid for 12 months from the date of installation.
Repairs to the electric, hydraulic or gas circuits may be carried out only by your local authorized MTS Servicing Centre.

*Despite every attempt has been made to avoid errors of any kind in this Owner's Manual, the Management invites customers to inform of any inaccuracies which they may find.
This will help to improve our service.*

IMPORTANT INSTRUCTIONS

Read the instructions and recommendations in this owner's manual carefully to ensure proper installation, use and maintenance of the appliance.

Keep this owner's manual in a safe place.

You may need it for your own reference while our Servicing Centre technicians or your installer may need to consult it in the future.

WARNING

This appliance is designed to produce hot water. It must be connected to a central heating system or to hot water mains system suited to its specifications and capacity.

This appliance **MUST BE USED ONLY** for the purpose for which it is designed.

The manufacturer declines all liability for damage caused by improper or negligent use.

BEFORE CONNECTING the appliance check that the information shown on the data plate and the table on pages 4-5 comply with the electric, water and gas mains of your home.

You will find the data plate on the control panel.

The gas with which this appliance operates is also shown on the label at the bottom of the boiler.

DO NOT install this appliance in a damp environment or close to equipment which spray water or other liquids.

DO NOT PLACE objects on the appliance.

DO NOT ALLOW children or inexperienced persons to use the appliance without supervision.

If you smell gas in the room, **DO NOT TURN ON** light switches, use the telephone or any other object which might cause sparks.

Open doors and windows immediately to ventilate the room.

Shut the gas mains tap (on the gas meter) or the valve of the gas cylinder and call your Gas Supplier immediately.

If you are going away for a long period of time, remember to shut the mains gas tap or the gas cylinder valve.

ALWAYS DISCONNECT the appliance either by unplugging it from the mains or turning off the mains switch before cleaning the appliance or carrying out maintenance.

IN THE CASE OF FAULTS OR FAILURE, switch off the appliance and turn off the gas tap. Do not tamper with the appliance.

For repairs, call your local Authorized Servicing Centre and request the use of original spare parts.

For in guarantee repairs contact MTS (GB) LIMITED

NEVER block the ventilation outlet of the compartment in which the boiler is installed with rags or paper.

CHECK the following at least once a year:

- 1 - Check the seal of water connections, replacing the gaskets if necessary.
- 2 - Check the seal of the gas connections, replacing the gaskets if necessary.
- 3 - Check the general condition of the appliance and of the combustion chamber visually.
- 4 - Visual check of the combustion: clean burners if necessary.
- 5 - With reference to point 3, dismount and clean the combustion chamber if necessary.
- 6 - With reference to point 4, dismount and clean the injectors if necessary.
- 7 - Visual check of the primary heat exchanger:
 - check for overheating of the exchangers fins;
 - clean the fume side of the exchanger if necessary.
- 8 - Regulate the gas pressure, ignition pressure, partial flame, maximum flame.
- 9 - Check proper operation of the heating safety system:
 - maximum safety temperature;
 - maximum safety pressure.
- 10 - Check the proper operation of the gas safety system:
 - gas or flame safety device;
 - gas valve safety device.
- 11 - Check that the electric connections have been made in compliance with the instructions shown in the owner's manual.
- 12 - Check the efficiency of the hot water supply (flow and temperature).
- 13 - General operating check of the appliance.
- 14 - Check room ventilation.
- 15 - Check the exhaust system for the combustion products.

**FAILURE
TO FOLLOW THE
ABOVE INSTRUCTIONS
MAY COMPROMISE
THE SAFETY OF THE
APPLIANCE**

1 GENERAL INFORMATION

1.1 OVERALL VIEW

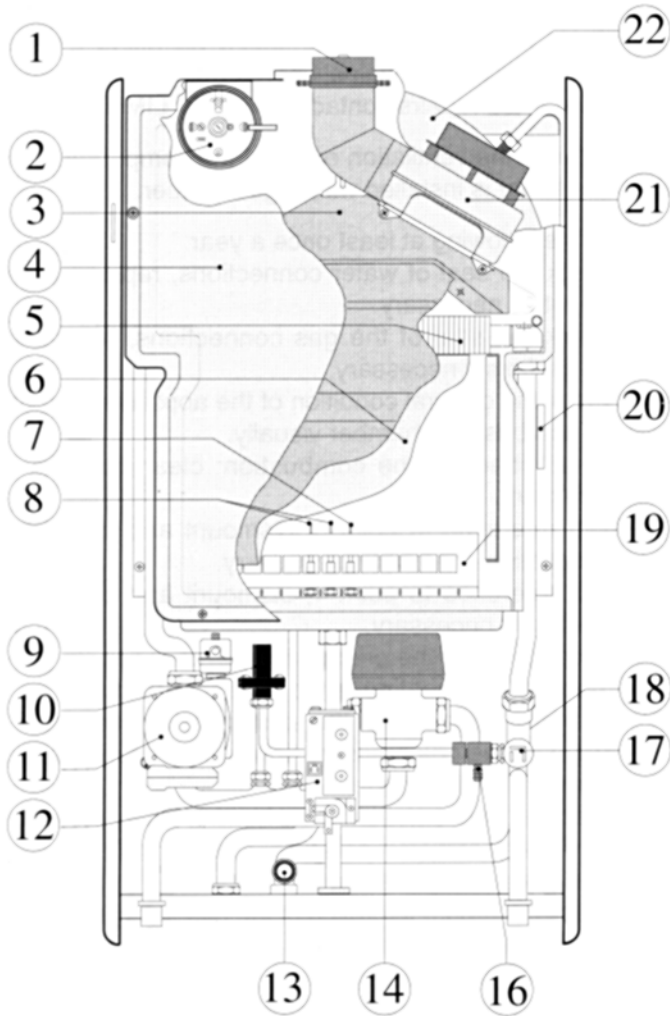

- 1 Venturi device.
- 2 Air pressure switch.
- 3 Flue hood.
- 5 Main exchanger
- 4 Sealed combustion chamber.
- 6 Insulation panel.
- 7 Detection electrode.
- 8 Ignition electrodes.
- 9 Automatic air release valve.
- 10 Main flow switch.
- 11 Pump
- 12 Gas valve.
- 13 Safety valve.
- 14 Three way motorized valve.
- 16 Central heating drain cock.
- 17 Pump pressure switch.
- 18 Hydraulic multi connections.
- 19 Main burner.
- 20 Overheat thermostat probe.
- 21 Fan.
- 22 Expansion vessel.

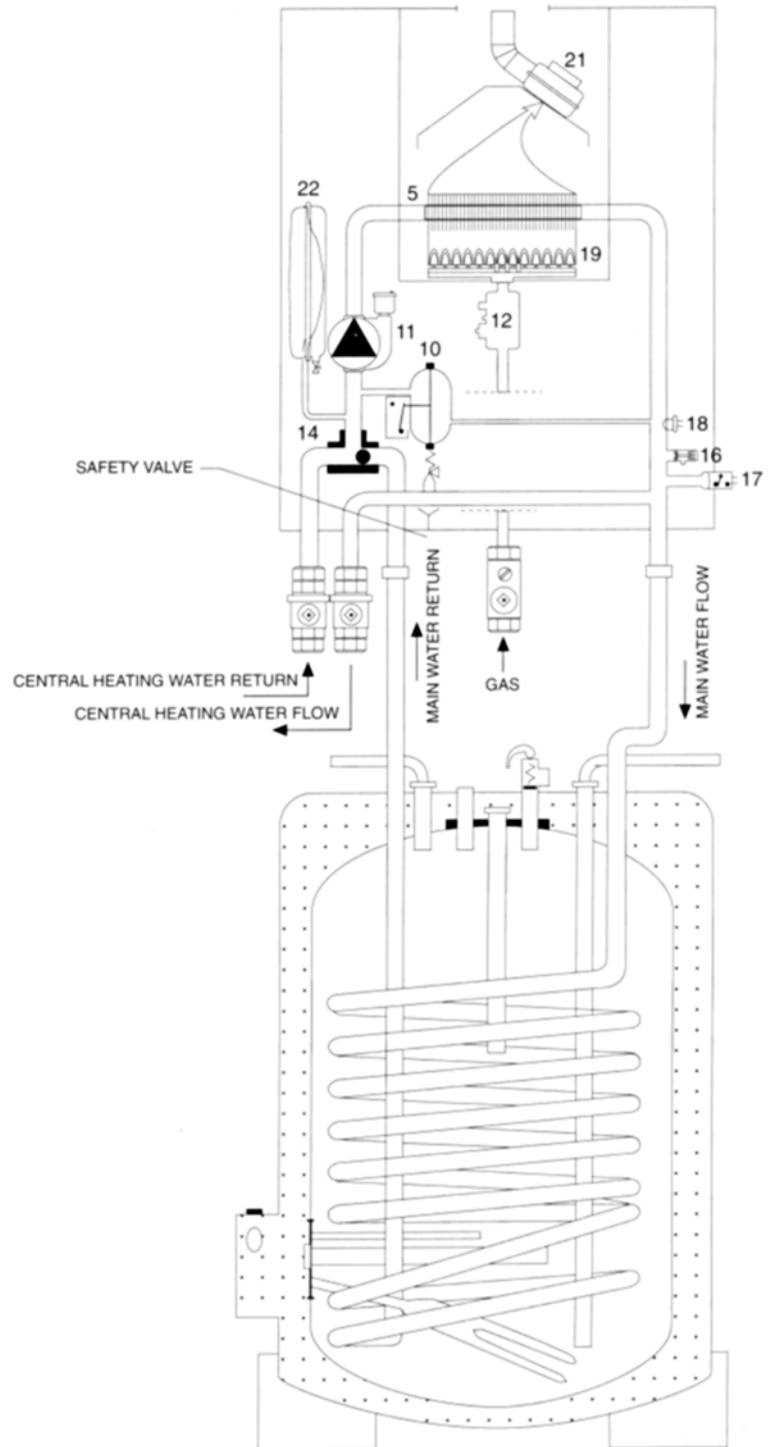

General information

1.2 TECHNICAL DATA

Model DIA SYSTEM 27 RFFI

The ARISTON DIA SYSTEM 27 RFFI is a central heating (c.h.w.) appliance.

It is produced as a room sealed category appliance suitable for wall mounting applications only.

This boiler is suitable only for sealed system.

Heating input	max	29.8 kW	101000 Btu/h
Heating input	min	12.0 kW	40800 Btu/h
Heating output	max	27.3 kW	92800 Btu/h
Heating output	min	10.1 kW	34500 Btu/h

CENTRAL HEATING

Operating temperature	max	87 °C	
Operating temperature	min	45 °C	
Working pressure	max	2.5 bar	36.25 p.s.i.
Water content		2.7 lts	0.6 gals.
Built-in expansion vessel - Total capacity		7 lts	1.53 gals.
Built-in expansion vessel - Pre-charge pressure		1 bar	14.5 p.s.i.
Available head at 1000 lts./h (220 gals./h)		3.00 m w.g.	118.1 ins w.g.
Temp. difference for flow and return		20 °C	
Flow rate of water through the appliance		1000 lts./h	219.3 gals./h
Max permissible cold water capacity without additional expansion vessel ⁽¹⁾		70 lts./h	15.3 gals./h

ELECTRICAL DATA

Electrical supply	230 V
Frequency	50 Hz
Power consumption	200 W
Internal fuse rating	FAST 2 AT

CONNECTIONS

Gas connection	15 mm o.d.
C.h. flow	22 mm o.d.
C.h. return	22 mm o.d.
Safety discharge pipe	15 mm o.d.

STANDARD FLUE PIPES SPECIFICATIONS

Outer diameters	Flue exhaust pipe	60 mm	2.36 ins
Outer diameters	Air intake pipe	100 mm	3.93 ins
Standard length		1000 mm	39.38 ins
Maximum length ⁽²⁾		3000 mm	118.1 ins

OTHER SPECIFICATIONS

Height	895 mm	35.24 ins
Width	480 mm	18.90 ins
Depth	360 mm	14.17 ins
Dry weight	55 Kg	121 lb

GAS REQUIREMENTS		NATURAL GAS (G20)		BUTANE GAS (G30)		PROPANE GAS (G31)	
Gas rate	max	3.0 m ³ /h	106.0 ft ³ /h	0.88 m ³ /h	31.1 ft ³ /h	1.15 m ³ /h	40.6 ft ³ /h
Gas rate	min	1.2 m ³ /h	42.3 ft ³ /h	0.35 m ³ /h	12.3 ft ³ /h	0.46 m ³ /h	16.2 ft ³ /h
Inlet pressure		20 mbar	7.8 in w.g.	28 mbar	10.9 in w.g.	37 mbar	14.4 in w.g.
Burner pressure	max	12.3 mbar	4.8 in w.g.	28 mbar	10.9 in w.g.	37 mbar	14.4 in w.g.
Burner pressure	min	2.0 mbar	0.8 in w.g.	5.1 mbar	2.0 in w.g.	7.0 mbar	2.7 in w.g.
Burner injectors		15 x 1.25		15 x 0.72		15 x 0.72	

(1) If required an external expansion vessel can be fitted

(2) Using one or more horizontally elongated flue pipes kits (see sect. 1.3)

General information

1.3 AVAILABLE PUMP HEAD

The curve at pag.52 shows the water pressure (head) available to the central heating (c.h.) circuit as a function of flow; the load loss of the appliance has already been subtracted.

1.4 FLUE PIPE OPTIONAL EXTRAS

For a full report about flue pipe optional extras, please consult "flue pipe accessories !"

1.5 DESIGN PRINCIPLES AND OPERATING SEQUENCE

The fundamental concept behind this type of boiler is the production of a general source of heat by burning a combustible gas, which may be either methane or LPG. This heat is then transferred to the water moving through the main circuit (see fig. 1.1) by means of an exchanger. The main circuit, in turn, must be connected to an hydraulic circuit designed for heating purposes.

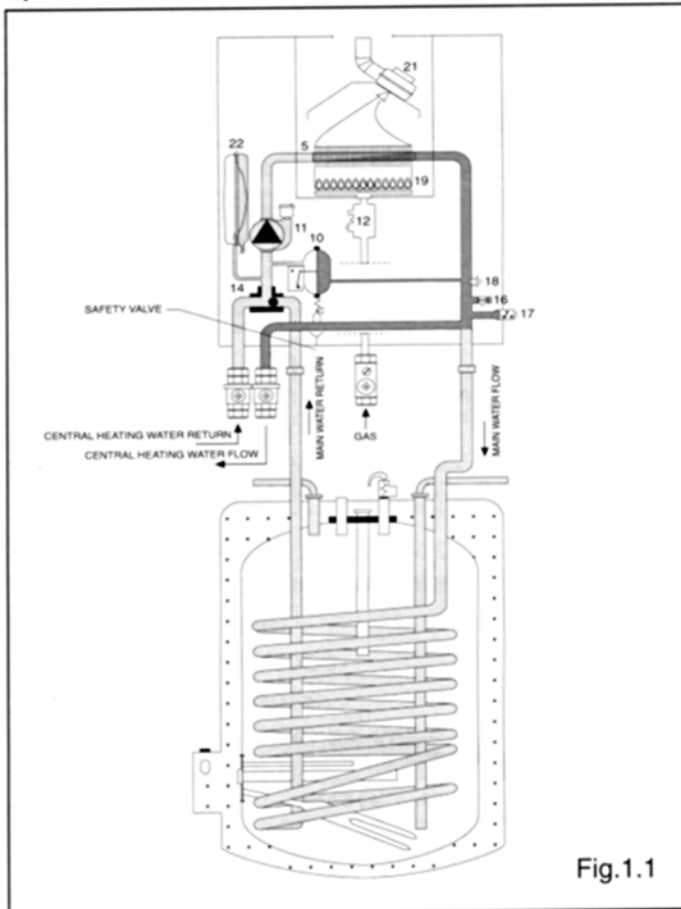

Fig.1.1

This boiler is designed to be used in conjunction with an indirect water storage cylinder (external to the boiler).

When water for ordinary household use is turned on, a motorized diverter valve built into the boiler diverts the flow of water coming from the primary heat exchanger to the storage tank coil.

The cold water from the mains will automatically pass through the boiler where it will absorb heat emanating from the coil so that it reaches the required temperature (see fig. 1.2).

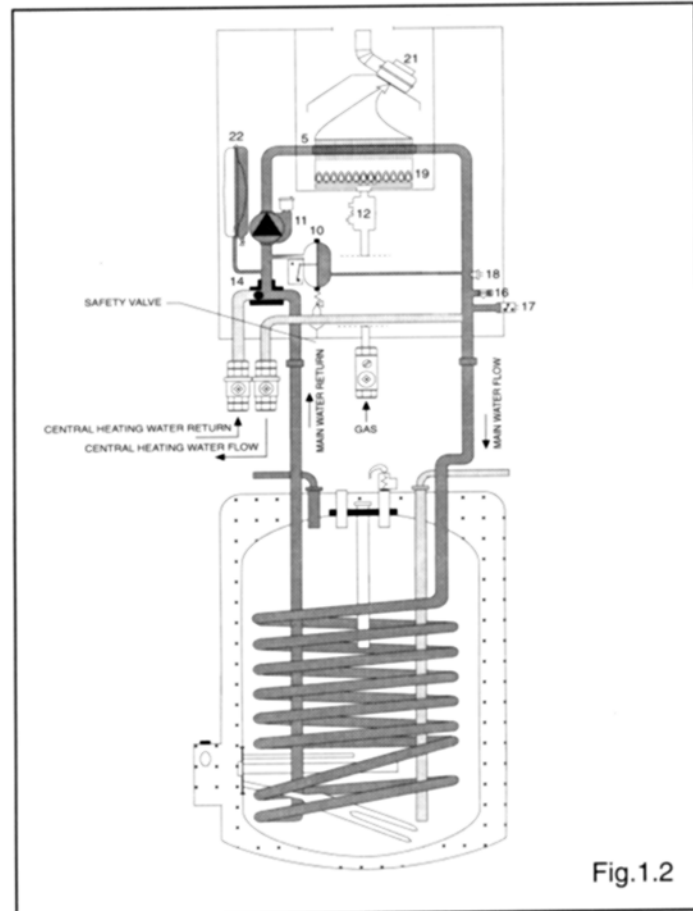

Fig.1.2

Operating Procedure

This boiler is designed with two selector switches, F and G, which allow you to turn on or off both the domestic water and heating functions. The table on page 5 shows all of the possible setting combinations for the two switches. Setting number 4 is a "stand-by" mode in the event you want to temporarily turn off both functions while leaving the system's electrical components turned on. This domestic and central heating water is equipped with electronically controlled ignition.

To turn on the boiler, simply turn the On/Off switch "E" to the On position "I". At this point the system is ready for use: an electronic device will automatically light the main burner when the domestic h.w./central h.w. functions are triggered. No other action is required.

After one or both functions have been selected, the "L" red warning light will light up for safety purposes if the burner does not light within the preset time limit. Press it to reset the ignition system. In the event that the burner fails to light a second time, make sure that the gas cock is open and repeat the procedure. If the burner still does not light, call a qualified technician for assistance.

General information

Before reading the following instructions please look up the control panel layout on the internal end cover.

Central heating water (c.h.w.) only ① installation without room thermostat :

- Turn the switch "F" to the "III" setting;
- Make sure that the switch "G" is turned to the "⚡" setting;
- Turn the electrical supply for the system on by turning the switch "E" to the "I" setting;
- Adjust the temperature of the water by turning the knob "D"; the temperature can be set between 42°C and approximately 82°C;
- Check the c.h.w. temperature using the thermometer "B".

In this type of installation, the c.h.w. thermostat directly influences the ambient temperature, and the pump remains in operation.

Installation with room thermostat:

- Turn the switch "F" to the "III" setting;
- Make sure that the switch "G" is turned to the "⚡" setting;
- Turn the electrical supply for the system on by turning the switch "E" to the "I" setting;

In this case, the boiler is controlled by the room thermostat in the sense that it remains on until the temperature selected has been reached.

Once the selected temperature has been reached, the main burner automatically turns off along with the pump.

Domestic hot water (d.h.w.) only ②

- Turn the switch "G" to the "⚡" setting;
- Make sure that the switch "F" is turned to the "III" setting;
- Adjust the temperature for the d.h.w. (from 40°C to approximately 70°C) by turning the knob C;
- Turn on the boiler by turning the switch "E" to the "I" setting;
- The burner will automatically turn off once the water in the tank has reached the temperature selected; it will remain in operation if the hot water is in continuous use. It is recommended that you avoid setting the thermostat at high temperatures and then mixing the hot water with cold. It is best to set the thermostat at middle-range temperatures.
- By leaving the switch "G" on the "⚡" setting, the burner will automatically ignite when activated by the thermostat located in the storage tank. This occurs if the water temperature varies; if the water in the tank is used, or if the water cools by more than 5°C.

C.h. and d.h. water operation: ③

- Turn the switch "G" to the "⚡" setting;
- Adjust the temperature of the water (from 40°C to approximately 70°C) by turning the knob C;

- Make sure that the switch "F" is turned to the "III" setting;

Without room thermostat:

- Adjust the temperature of the water by turning the knob "D"; the temperature can be set between 42°C and approximately 82°C;
- Check the c.h. temperature using the thermometer "B".

In this type of installation, the c.h. thermostat directly influences the ambient temperature, and the pump remains in operation.

With room thermostat:

In this case, the boiler is controlled by the room thermostat in the sense that the system remains on until the temperature selected has been reached.

Once the selected temperature has been reached, the main burner automatically turns off along with the pump.

The domestic hot water function takes priority over the central heating unit function:

- It is recommended that you avoid setting the thermostat at high temperatures and then mixing the hot water with cold. It is best to set the thermostat at middle-range temperatures.
- By leaving the switch "G" on the "⚡" setting, the burner will automatically ignite when activated by the thermostat located in the cylinder. This occurs if the water temperature varies; if the water in the tank is used, or if the water cools by more than 5°C.

Turning the boiler off

To turn the boiler off and deactivate the electrical components of the system, simply turn the switch "E", to the "O" setting.

Table of Possible Function Combinations

①	DOMESTIC HOT WATER (D.H.W.) - ON	⚡	CENTRAL HEATING WATER (C.H.W.) - OFF	III
②	DOMESTIC HOT WATER (D.H.W.) - OFF	⚡	CENTRAL HEATING WATER (C.H.W.) - ON	III
③	DOMESTIC HOT WATER (D.H.W.) - ON	⚡	CENTRAL HEATING WATER (C.H.W.) - ON	III
④	DOMESTIC HOT WATER (D.H.W.) - OFF	⚡	CENTRAL HEATING WATER (C.H.W.) - OFF	III

2 GENERAL REQUIREMENTS

This appliance must be installed by a competent installer in accordance with the 1984 Gas Safety (installation & use) Regulations (as amended).

2.1 RELATED DOCUMENTS

The installation of this appliance must be in accordance with the relevant requirements of the 1984 Gas Safety (installation & use) Regulations, the Local Building Regulations, the current I.E.E. Wiring Regulations, the by laws of the local water undertaking, and in Scotland, in accordance with the Building Standards (Scotland) Regulation. Health and safety document n° 635 "Electricity at work regs. 1989".

Installation should also comply with the following British Standard Codes of Practice:

Low pressure pipes	BS 6891	1988
Boilers of rated input not exceeding 60 kW	BS 6798	1987
Forced circulation hot water system	BS 5449	1990
Installation of gas hot water supplies for domestic purposes (2 nd family gases)	BS 5546	1990
Flues	BS 5540-1	1990
Air supply	BS 5540-2	1989

2.2 LOCATION OF APPLIANCE

The appliance may be installed in any room or indoor area, although particular attention is drawn to the requirements of the current I.E.E. Wiring Regulations, and in Scotland, the electrical provisions of the Building Regulations applicable in Scotland, with respect to the installation of the combined appliance in a room containing a bath or shower.

Where a room-sealed appliance is installed in a room containing a bath or shower, any electrical switch or appliance control, utilising mains electricity should be situated so that it cannot be touched by a person using the bath or shower.

The location must permit adequate space for servicing and air circulation around the appliance (see fig. 3.1-a and 3.1-a).

The location must permit the provision of an adequate flue and termination.

For unusual locations special procedures may be necessary.

BS 6798-1987 gives detailed guidance on this aspect.

A compartment used to enclose the appliance must be designed specifically for this purpose.

This appliance is not suitable for outdoor installation.

2.3 FLUE SYSTEM

The provision for satisfactory flue termination must be made as described in BS 5440-1.

The appliance must be installed so that the flue terminal is exposed to outdoor air.

The terminal must not discharge into another room or space such as an outhouse or lean-to.

It is important that the position of the terminal allows a free passage of air across at all times.

The terminal should be located with due regard for the damage or discoloration that might occur on buildings in the vicinity.

In cold and/or humid weather water vapour may condense on leaving the flue terminal.

The effect of such "steaming" must be considered.

The minimum acceptable spacing from the terminal to obstructions and ventilation openings are specified in fig. 2.1.

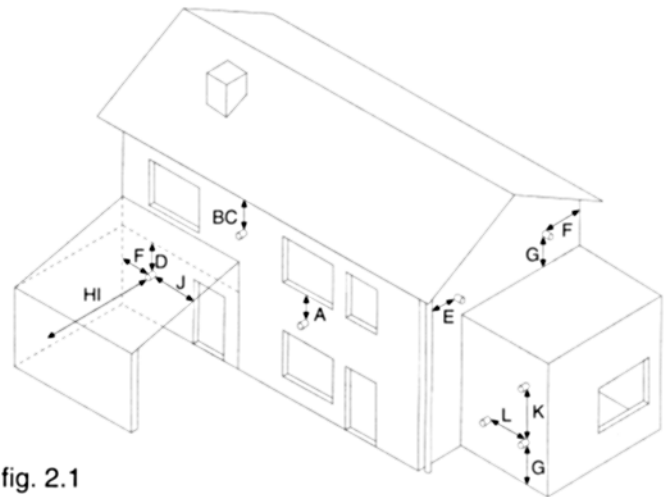

fig. 2.1

TERMINAL POSITION	mm
A - Directly below an open window or other opening	300
B - Below gutters, solid pipes or drain pipes	75
C - Below eaves	200
D - Below balconies or car port roof	200
E - From vertical drain pipes and soil pipes	75
F - From internal or external corners	300
G - Above ground or below balcony level	300
H - From a surface facing a terminal	600
I - From a terminal facing a terminal	1200
J - From an opening in the car port (e.g. door, window) into dwelling	1200
K - Vertically from a terminal in the same wall	1500
L - Horizontally from a terminal in the same wall	300

2.4 GAS SUPPLY

The gas meter is connected to the service pipe by the local gas region contractor.

If the gas supply for the boiler serves other appliances ensure that an adequate supply is available both to the boiler and the other appliance when they are in use at the same time.

Pipework must be of an adequate size. Pipes of a smaller size than the boiler inlet connection should not be used.

Installation pipes should be fitted in accordance with BS 6891-1988 and the complete installation should be tested for soundness.

General requirements

2.5 AIR SUPPLY

The room in which the boiler is installed does not require a purpose provided air vent.

If installed in a cupboard or compartement, ventilation is required for cooling.

Recommendations for air supply are detailed in BS 5440-2.

The following notes are for general guidance.

The minimum effective area requirement is:

230.4 cm² / 34.9 in² at high level

230.4 cm² / 34.9 in² at low level

The figures quotes relate to the ventilation requirement if the ventilation is into a room. If the ventilation is to the outside then the above sizes can be halved.

2.6 WATER CIRCULATION (Central heating)

Detailed recommendations are given in BS 6798-1987 and BS 5449-1 1990; the following notes are given for general guidance.

Pipework

Copper tubing to BS 2871-1 1977 is recommended for water pipes. Jointing should be either with capillary soldered or compression fittings.

Where possible pipes should have a gradient to ensure air is carried naturally to air release points and water flows naturally to drain taps.

The appliance has a built-in automatic air release valve;

it should be ensured as far as possible that the appliance heat exchanger is not a natural collecting point for air. Except where providing useful heat, pipes should be insulated to prevent heat loss and avoid freezing. Particular attention should be paid to pipes passing through ventilated spaces in roofs and under floors.

Installation of by-pass

The installation of a by-pass is essential if all radiators have been equipped with thermostatic valves. The suggested method of installation is shown on fig. 2.2

System design

This boiler is suitable only for sealed systems.

A typical lay-out is illustrated in fig. 2.2.

Drain cocks

These must be located in accessible positions to permit the draining of the whole system. The taps must be at least 15 mm nominal size and manufactured in accordance with BS 2870-1980.

Air release points

These must be fitted at all high points where air naturally collects and must be sited to facilitate complete filling of the system.

The appliance has an integral sealed expansion vessel to accomodate the increase of water volume when the system is heated.

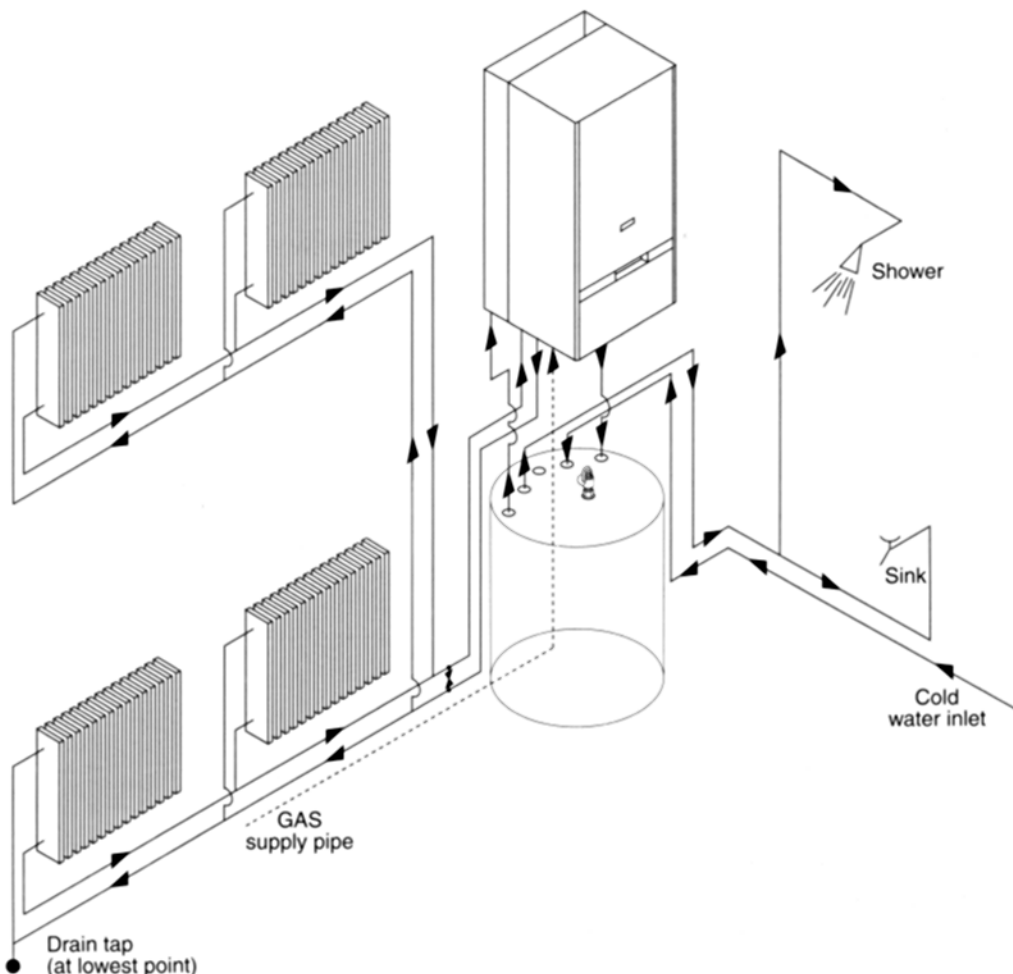

fig. 2.2

General requirements

It can accept up to 7 lts (1,5 gals.) of expansion water.
If the heating circuit has an unusually high water content, calculate the total expansion and add additional sealed expansion vessel with adequate capacity.

Mains water feed: central heating

No direct connection to the mains water supply even through a non return valve, may be made without the approval of the Local Water Authority.

Filling

A method for initially filling the system and replacing water lost during servicing must be provided and it must comply with local water authority regulations.

A possible method is shown in fig. 2.3.

The installer should ensure that no leaks exist as frequent filling of the sytem could cause premature scaling of the heat exchanger.

2.7 DOMESTIC WATER

The domestic water must be in accordance with the relevant recommendations of BS 5546. Copper tubing to BS 2871-1 is recommended for water carrying pipework and must be used for pipework carrying drinking water.

2.8 ELECTRICAL SUPPLY

Warning, this appliance must be earthed.

External wiring to the appliance must be carried out by a qualified technician and be in accordance with the current I.E.E. Regulations and applicable local regulations .
The ARISTON DIA SYSTEM 27 RFFI is supplied for connection to a 230 V- 50 Hz supply.
The supply must be fused at 3 A.

The method of connection to the electricity supply must facilitate complete electrical isolation of the appliance by the use of a fused double pole isolator having a contact separation of the least 3 mm in all poles or alternatively, by means of a 3 A fused three pin plug and unswitched shuttered socket outlet both complying with BS 1363.

The point of connection to the Electricity supply must be readily accessible and adjacent to the appliance unless the appliance is installed in bathroom when this must be sited outside the bathroom.

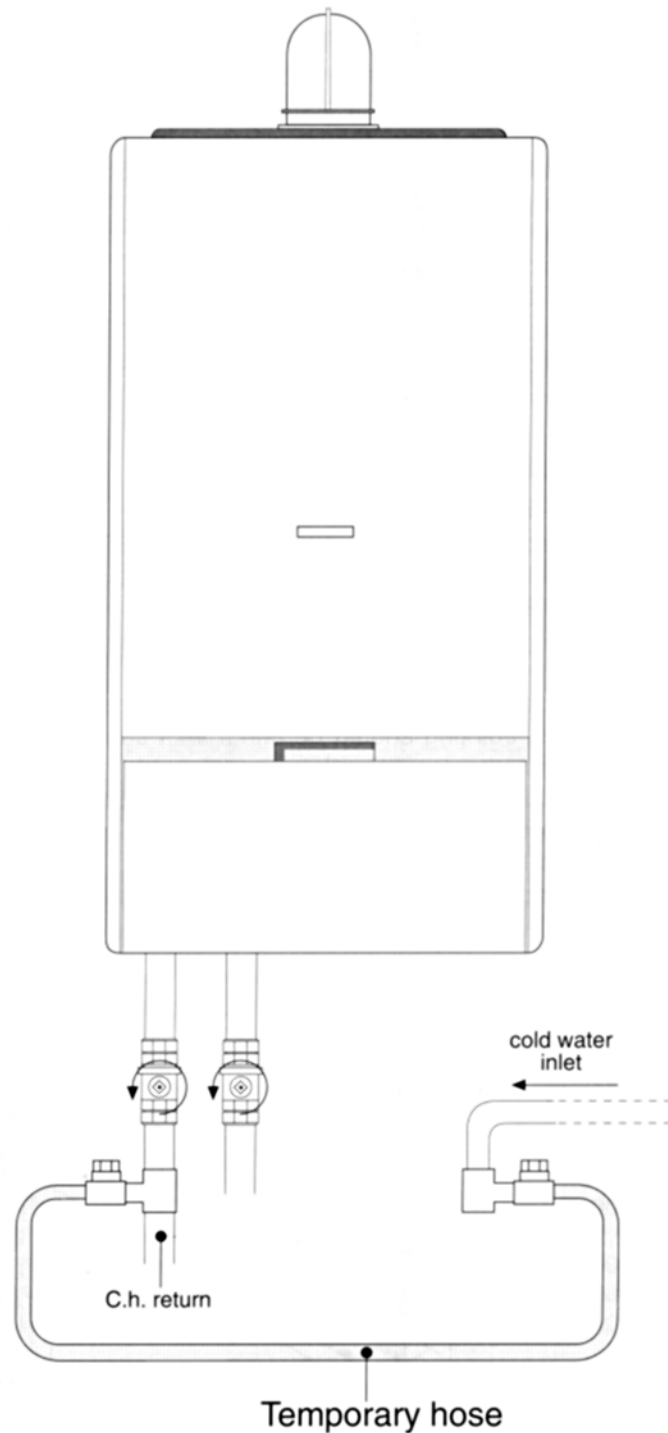

fig. 2.3

3 INSTALLATION

3.1 DELIVERY

There will be 2 items:

- 1 - The fully assembled boiler;
- 2 - Standard flue assembly which include flue pipes and 90° elbow

3.2 MEASUREMENTS FOR INSTALLING THE APPLIANCE

Model DIA SYSTEM 27 RFFI

IMPORTANT!

To allow easy access to the interior of the boiler for maintenance work, keep to the minimum dimensions shown in the drawing.

fig. 3.1

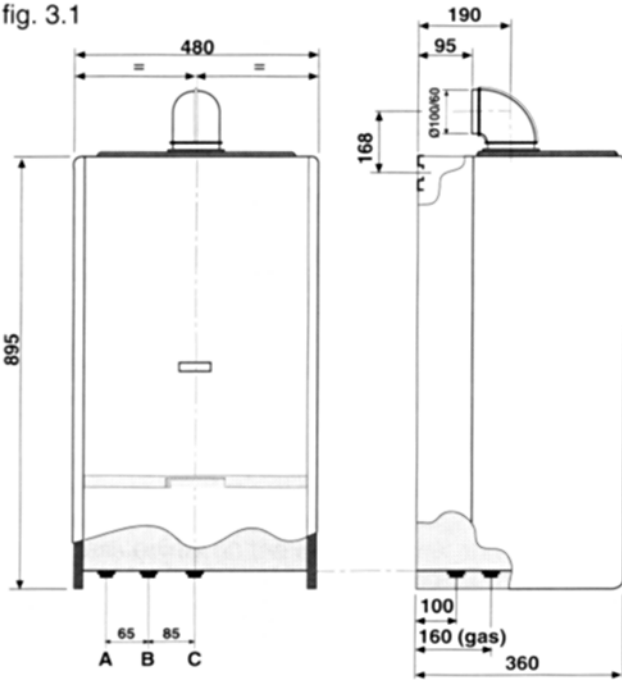

- A: C.h.w. return
- B: C.h.w. flow
- C: Gas inlet
- D: D.h.w. outlet
- E: D.w. inlet

FRONT VIEW

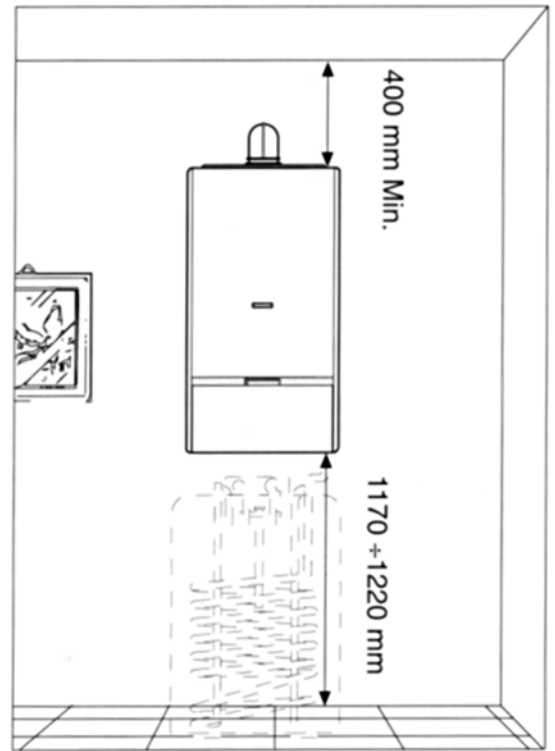

TOP VIEW

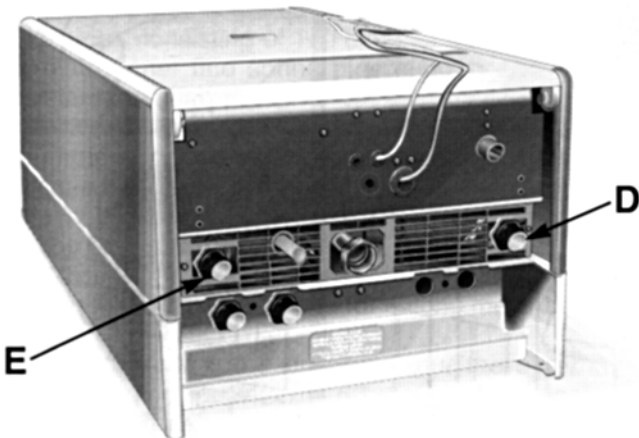
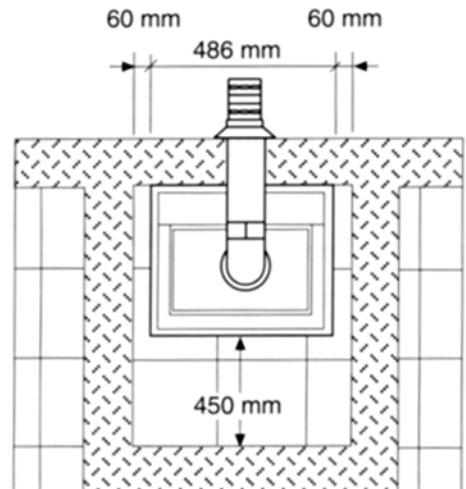

Installation

3.3 UNPACKING THE BOILER

- 1 - Turn the carton upside down and open;
- 2 - Turn the carton right way up;
- 3 - Remove the carton;
- 4 - Remove valves pack, documentation and all polystyrene packing.

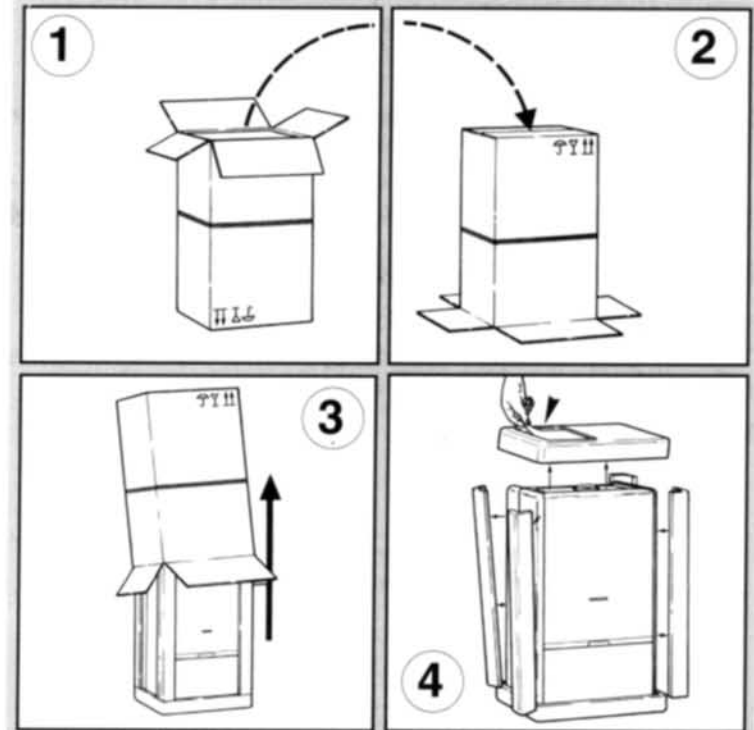

fig. 3.2

IMPORTANT!

All of the boiler packaging (carton and polystyrene) is fully recyclable.



IMPORTANT!

All packaging must be properly and thoroughly disposed of, as some components (i.e.: polythene, staples etc.) could prove to be dangerous to young children.

3.4 POSITIONING OF THE BOILER

(see fig. 3.3).

- 1 - After the fixing position has been determined, allowing for clearances as shown in section 3.1, fix paper template to the wall;
- 2 - Drill holes for flue "A" (A = 110 mm diam.) and wall plate fixing "B" (B = 14 mm diam.);
- 3 - Plumb service pipes to position "C";
- 4 - Remove template from wall. Position hanging plate "D" and secure to wall via pre-drilled holes "B" ensuring that it is level.
Important: please ensure that the fixing method used is able to support 60 Kg.

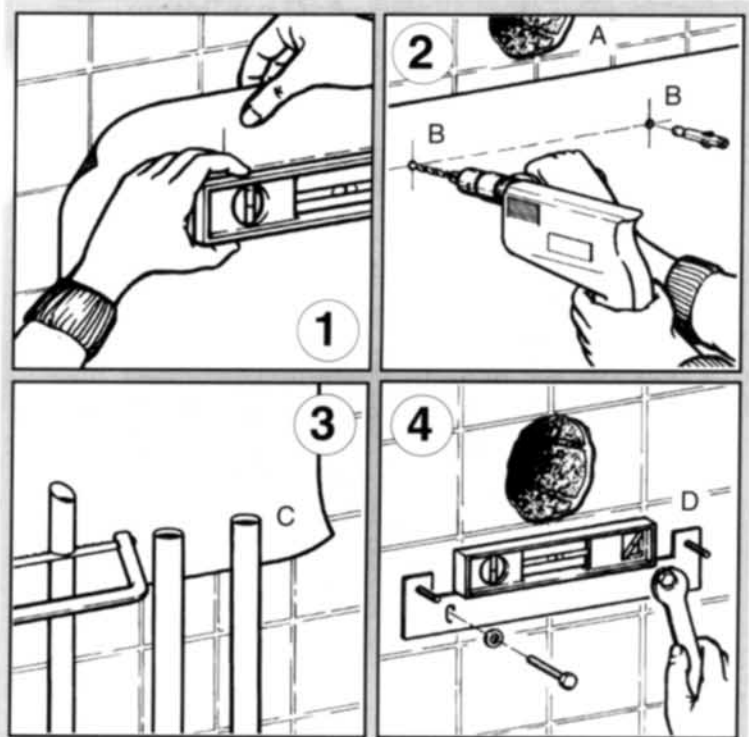

Installation

- 5 - Mount fitting valves connections;
- 6 - Hang the boiler on to bolts via holes in the boiler frame "F";
- 7 - Secure boiler with nuts "G" ensuring that washers are positioned between the nut and the boiler frame.

NOTE:

During the drilling of the hole for the flue air intake, ensure that its diameter is larger than the pipe. This is to ensure that the pipe can be removed if required. The seal between pipe and wall is assured by internal and external flanges (see figure 3.5 below).

HYDRAULIC CONNECTION TO THE STORAGE TANK

Instal pipework according to this instruction manual but consult the additional tank instruction manual to carry out the connections and to correctly instal any components needed.

CONNECTING THE SENSOR FOR THE WATER HEATER TO THE EXTERNAL BOILER

- 1 - The sensor located beneath the unit appears to be a power supply cable. An adhesive label wrapped around the cable identifies is as a sensor.
- 2 - Remove the cover to gain access to the electrical components of the external tank.
- 3 - Unwind the cable, pass it through one of the two access points on the external tank and insert the terminal into its proper sleeve. Make sure that terminal is fully inserted.
- 4 - Close the tank cover.

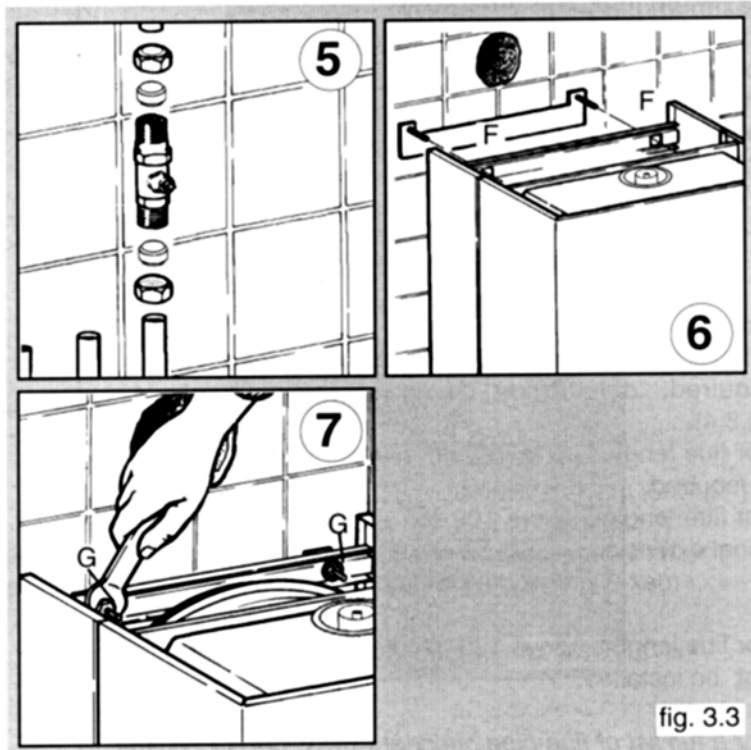

fig. 3.3

3.5 MOUNTING THE FLUE EXHAUST PIPES

Flue kit contains the following (see fig. 3.4):

- 1 - Seal gasket for 90° elbow to boiler;
- 2 - 60 diam. O-Ring - coloured red;
- 3 - 100/60 diam 90° elbow with internal recess for 60 diam. O-Ring;
- 4 - 60 diam. O-Ring - coloured red;
- 5 - Flue sealant gasket;
- 6 - Tightening band for sealant gasket;
- 7 - Internal flange - coloured white;
- 8 - External flange - coloured grey;
- 9 - Flue pipe - consisting of 100 diam. outer flue, 60 diam. inner flue spring pipe support and wind-resistant terminal;
- 10 - 4,2x13 self tapping screws ;
- 11 - Diaphragm for use with flue requirements between 50 cm and 100 cm.

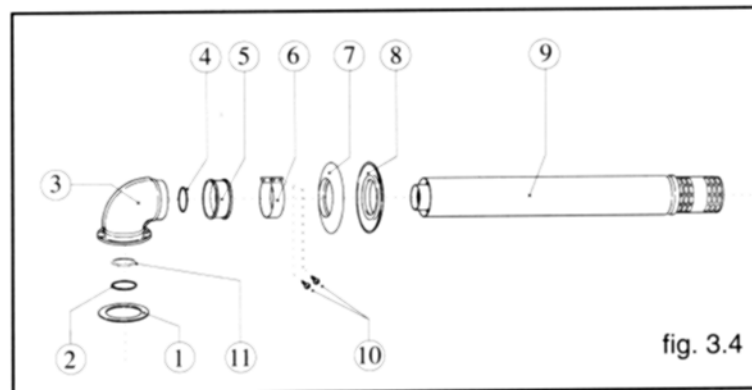

fig. 3.4

Cutting the flue exhaust

If your particular installation requires you to shorten the flue, see the following instructions for cutting measures.

N.B.: When shortening the flue pipe, cut the external 100 diam. pipe and the internal 60 diam. pipe, keeping the original difference in length between the two (35 mm). (see fig. 3.5).

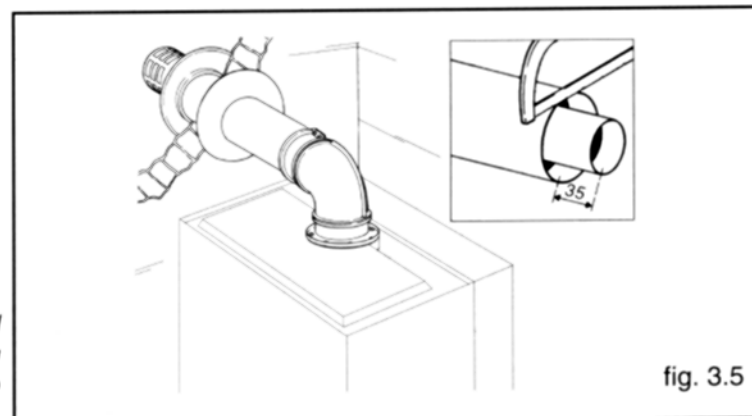

fig. 3.5

Installation

Maximum/minimum flue length

If you need to extend the flue or change its direction, optional kits are available.

All measures are in millimetres unless otherwise specified.

Both pipes must be cut on the side facing the elbow.

- 1 - Minimum flue length 'S' 500 mm (see fig. 3.7)
- 2 - Maximum flue length 'S' 3000 mm model DIA SYSTEM 27 RFFI

Note:

Where flue lengths between 50 cm and 100 cm are required, diaphragm '11' **must** be installed (see fig.3.4).

For flue lengths up to 100 cm only the standard flue kit is required.

For flue lengths above 100 cm and up to 300 cm additional extension kits will be required.

max 2 kits model DIA SYSTEM 27 RFFI.

For flue lengths above 100 cm the diaphragm '11' **must not** be installed.

For a full list of flue pipe optional extras, please consult "flue pipe accessories !"

Mounting operations (see fig.3.9)

- 1 - Fit the 100 diam. gasket into the housing at the top of the boiler and place the two 60 diam. O-Rings in the elbow housing. Insert diaphragm if required;
- 2 - Fix the elbow at the top of the boiler using the 4 selftapping screws and insert the stepped sleeve;
- 3 - Fit the external ring gasket and then insert the pipe (from the outside) into the hole made in the wall;
- 4 - Fit the internal ring gasket ;
- 5 - Connect the flue pipe to the bend; insert the 60 diam.pipe into the elbow through to the end and the 100 diam. pipe into the sleeve;
- 6 - Use the clamp to fix the elbow and external 100 diam. pipe together.

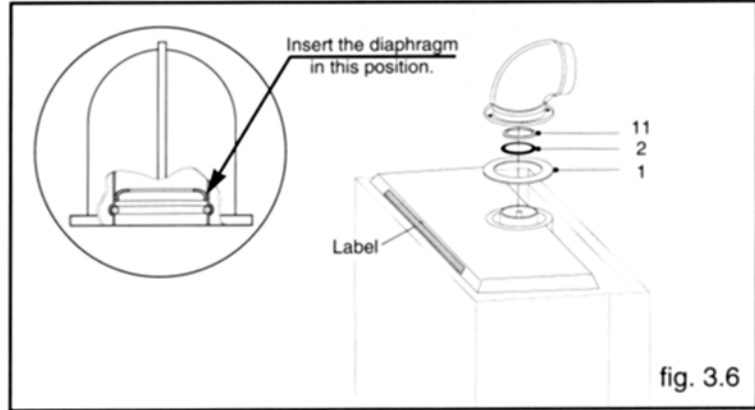

fig. 3.6

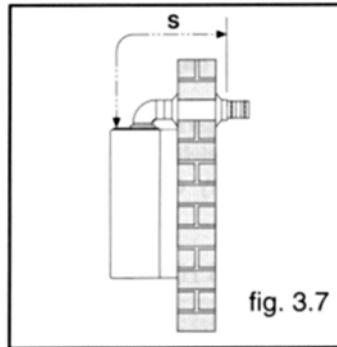

fig. 3.7

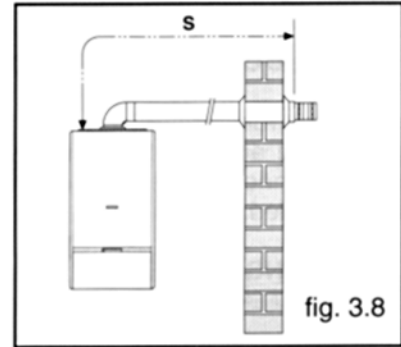

fig. 3.8

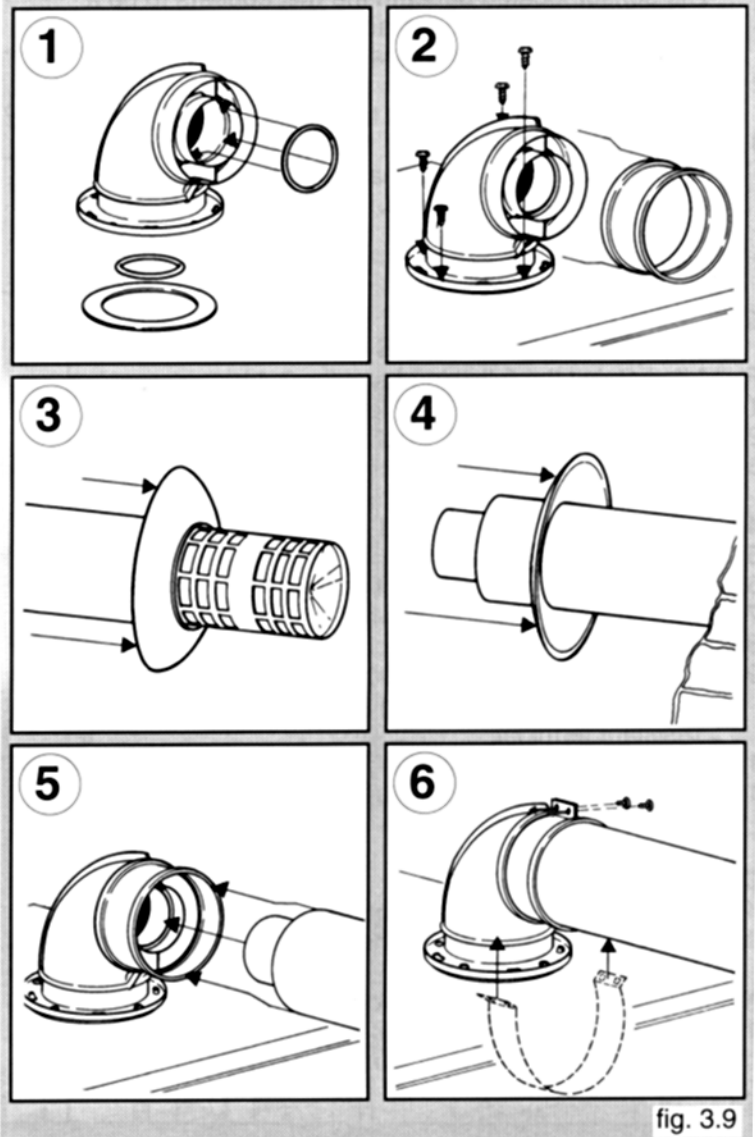

fig. 3.9

Installation

3.6 FLUE TERMINAL GUARD

Where the lowest part of the terminal is less than 2 m (6.4 ft) above the level of any ground, balcony, flat roof or place to which any person has access then a suitable terminal guard must be fitted. A suitable guard is available from:

TOWER FLUE COMPONENTS

Morley Road
Tonbridge
Kent TN19 1RA

When ordering the guard, quote appliance model number.
The guard should be fitted centrally over the terminal.

3.7 ELECTRICAL CONNECTIONS

Connecting to the electricity supply

WARNING - THIS APPLIANCE MUST BE EARTHED

The appliance is delivered with a flexible cable for electrical supply. The cable allows the electrical connection as detailed in sect. 2.8.

Replacing the electrical supply cable

- 1 - Ensure electricity is switched off at main isolator;
- 2 - Remove boiler casing (see sect. 6.2);
- 3 - Lower control panel (see sect. 6.2);
- 4 - Remove cables from terminals by loosening screws "A"
(see fig.3.10);
- 5 - Loosen screw "B" to slacken the cable holder;
- 6 - Remove the cable;
- 7 - Insert the new cable through grommet.
A PVC insulated flexible cable must be used. it must be a three core of size 0.75 mm² (24x0.2 mm) to BS6500 table 16;
- 8 - Connect the cable to the terminals marked as follows:
 - L Brown or red wire (live)
 - N Blue or black wire (neutral)
 - ⊕ Green/yellow or green wire (earth).

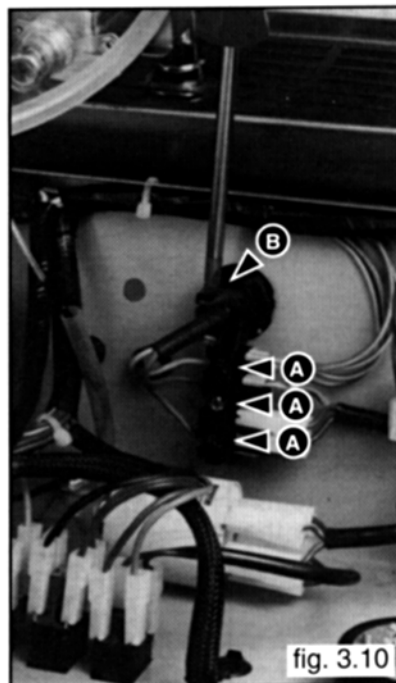

Installation

ELECTRICAL CONNECTION FOR THE TIME CONTROL CLOCK.

a) Insert the wire for the time control clock into the wire guide located on the bottom of the control panel.

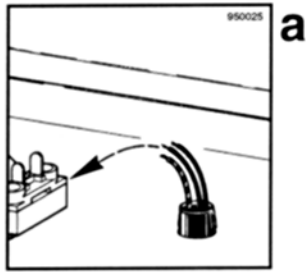

b) Remove the protective top cover from the terminal board. Remove the terminal board to facilitate the insertion of the wires.

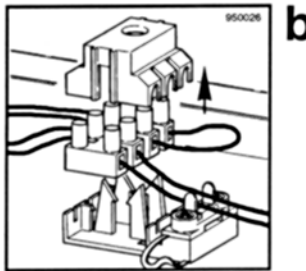

c) Remove the brown U-link. Insert the time control clock wires into the terminal board as shown in the diagram.

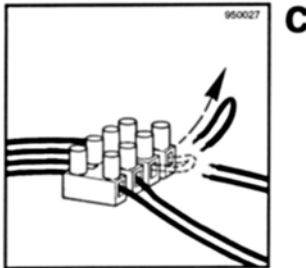

d) Remove the two screws on the wire clamps. Reinsert the terminal board, making sure that the wires pass through the appropriate openings.

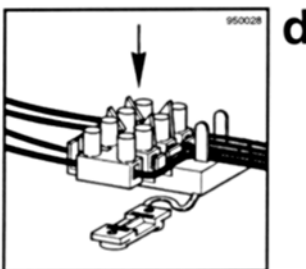

e) Replace the protective top cover for the terminal board and the wire clamp into their respective housings. Fasten them with the two screws.

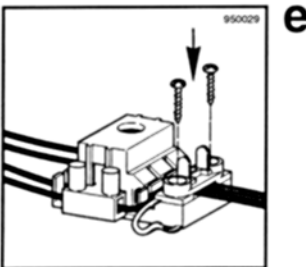

If an room thermostat is installed, make a serial connection:

f) Disconnect one of the two wires on the time control clock from the terminal board.

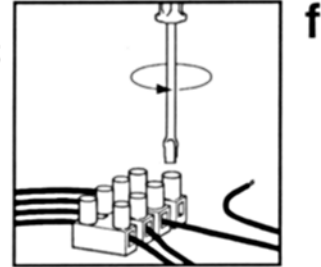

g) Connect the room thermostat to the free wire using a single terminal, or the like, and the free end on the thermostat to the terminal board.

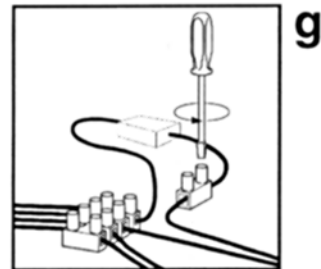

Note: Naturally, the same procedure can be followed in the opposite scenario: if the room thermostat has already been connected, break the connection as described at point f) and make a serial connection with the time control clock.

ATTENTION:

Install a room thermostat which can be opened solely by using a tool.

4 COMMISSIONING

4.1 ELECTRICAL INSTALLATION

Preliminary electrical system checks to ensure electrical safety must be carried out by a qualified electrician.

I.e. polarity, earth continuity, resistance to earth and short circuit.

If a fault has occurred on the appliance the fault finding procedure should be followed as specified under the servicing section of this document.

4.2 GAS SUPPLY INSTALLATION

- 1 Inspect the entire installation including the gas meter, test for soundness and purge, as described in BS6891;
- 2 Open the gas cock (drawn with the knob in "open" position on the appliance) and check the gas connector on the appliance for leaks (see fig. 4.1).

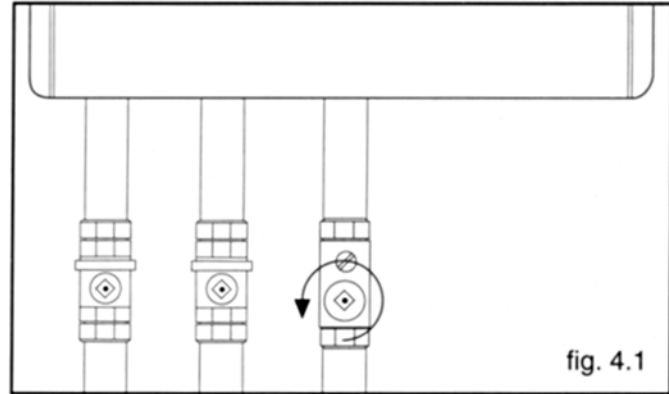

4.3 FILLING THE D.H.W. SYSTEM

- 1 Close all hot water draw-off taps;
- 2 Open the cold water inlet cock ;
- 3 Slowly open each draw-off tap and close it only when clear water, free of bubbles, is visible.

4.4 INITIAL FILLING OF THE SYSTEM

- 1 Open central heating flow and return cocks as indicated in fig. 4.2;
- 2 Unscrew the cap on the automatic air release valve one full turn and leave open permanently;
- 3 Close all air release valves on central heating system;
- 4 Gradually open stopcock at the filling point connection to central heating system until water is heard to flow; do not open fully;
- 5 Open each air release tap starting with the lower point and close it only when clear water, free of bubbles, is visible;
- 6 Remove the front panel of the case and lower the control panel (sect. 6.2);
- 7 Purge the air from the pump by unscrewing the pump plug indicated as indicated in fig. 4.3; release the pump by turning the rotor in the direction indicated by the arrow on the information plate;
- 8 Close the pump plug;
- 9 Continue filling the system until at least 1 bar (14.5 p.s.i.) registers on the temperature-pressure gauge;
- 10 Inspect the system for water soundness and remedy any leaks discovered.

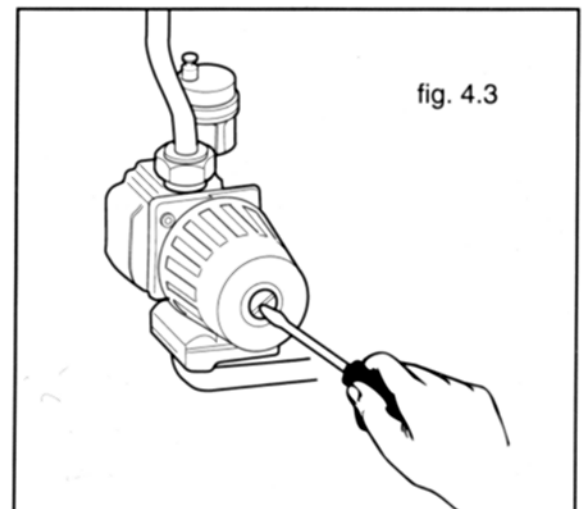
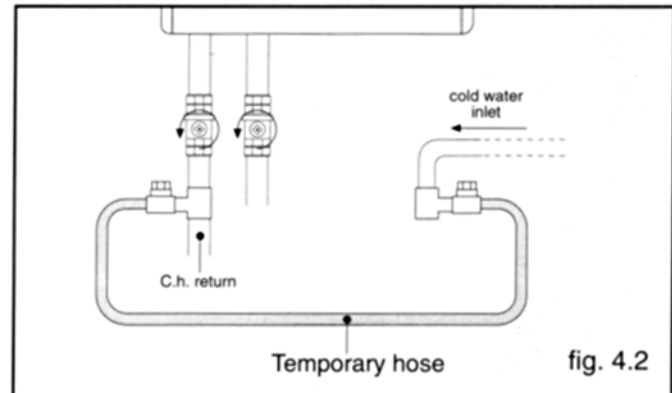

Commissioning

When the installation and filling are completed turn on the central heating system (sect. 4.5) and run it until the temperature has reached the boiler operating temperature.

The system must then be immediately flushed through.

The flushing procedure must be in line with BS7593:1992 *treatment of Water in Domestic Hot Water Central Heating Systems*.

During this operation, we highly recommend the use of a central heating flushing detergent, whose function is to dissolve any foreign matter which may be in the system i.e. Fernox Superfloc or equivalent.

Substances different from these, could create serious problems to the pump or others components.

We also recommend the use of an inhibitor in the system such as Fernox MB1 Universal or equivalent.

4.5 SETTING THE SYSTEM PRESSURE

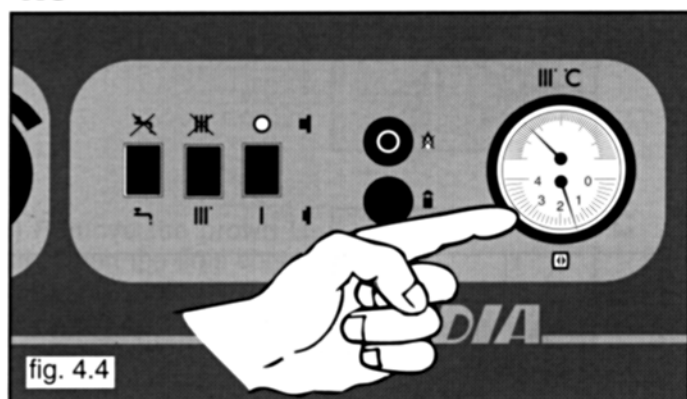

The actual reading should ideally be 1.5 bar (see fig. 4.4).

4.6 LIGHTING THE BOILER

If external controls are fitted e.g. Timeclock, room thermostat ensure that they " call for heat " .

1 Switch on the electricity and turn on boiler by pushing button "A", ensuring that the neon is on. (If neon does not come on then check electrical connections) (see fig. 4.5).

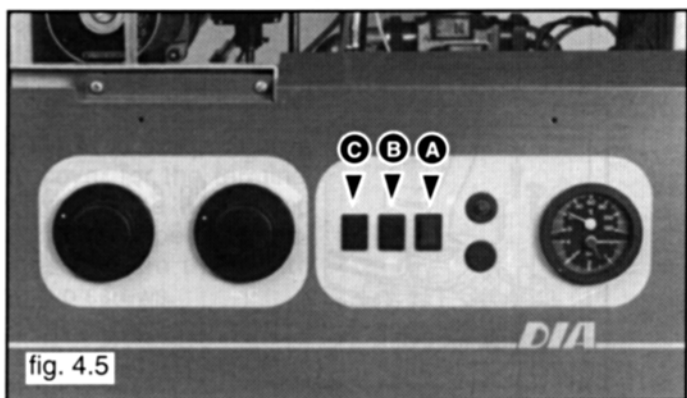

2 Select heating mode by setting button "B" to heating III mode (see fig. 4.5).

3 Check the burner pressures and adjust as necessary as in section 6.4.

The boiler will now go through an ignition sequence and the burner will light.

5 MAINTENANCE

5.1 GENERAL

To ensure efficient, safe operation of the appliance it is necessary to carry out routine maintenance at regular intervals.

The frequency of servicing will depend upon the particular installation conditions and the use of the boiler, but, in general, once a year should be adequate.

The following notes apply to the appliance but it should be remembered that attention must be also paid to the central heating and domestic hot water circuits with special attention to radiator valves; thermostats, clocks, leaking hot water taps etc.

WARNING

Before starting any servicing work, switch-off the electrical supply or disconnect the plug at the main isolating switch and socket (if a switch is used remove the fuse).

After any service on electrical components carry out a preliminary electrical checks; in particular:

earth continuity;

polarity;

earthing resistance;

short circuit.

5.2 RECOMMENDED ROUTINE MAINTENANCE

The following procedures should be carried out at least once a year:

- 1 Verify that the electrical connections, the flue pipe-work and the case are in good condition;
- 2 Inspect ventilation arrangements as explained in section 2.6 to ensure no alterations have been made since installation;
- 3 Switch-off the electrical supply and remove the front panel of the case (section 6.2);
- 4 Switch-on the electrical supply and run the boiler for few minutes in d.h.w. mode;
- 5 Check that the flame covers all the flame ports and is of a light blue colour. Yellow flames and excessive lifting of flames indicate poor combustion.
- 6 Visually check the flue system for soundness.

Check all clamps, gaskets and fixings are secure and tight. To check the exhaust gas, remove the right screw indicated in fig. 5.1 and connect the analyser to the flue gas sampling point.

To check the air inlet temperature, remove the left screw indicated in fig 5.1 and insert the probe of a thermometer.

To inspect and clean the appliance

- 7 Switch-off the electrical supply, remove the sealed chamber cover and open the combustion chamber (section 6.2);
- 8 If during initial check any combustion irregularity is suspected, remove the burner and the injectors (section 6.13).
Clean or replace if necessary;
- 9 Inspect the main heat exchanger for any deposits of soot. If cleaning is necessary place a cloth over the burner to catch debris and clean the main heat exchanger using a soft brush.
Do not use brushes with metallic bristles;
- 10 Inspect the combustion chamber panels.
Damaged panels should be replaced;
- 11 Examine the fan for any mechanical damage and check to ensure free running of the fan motor;
- 12 Check sealing gaskets and replace if required;
- 13 Replace all parts in reverse order with the exception of the case and the control panel;
- 14 Undertake a complete commissioning check as detailed in section 4;
- 15 Close-up the control panel and the case;
- 16 Clean the case using a soft cloth.



fig. 5.1

6 SERVICING INSTRUCTIONS

6.1 REPLACEMENT OF PARTS

The life of individual components varies and they will need servicing as and when faults develop.

The fault finding sequence chart in chapter 7 will serve to locate which component is the cause of any malfunction, and instructions for removal, inspection and replacement of the individual parts are given in the following pages.

6.2 TO GAIN GENERAL ACCESS

All testing and maintenance operations on the boiler require the control panel to be lowered. These operations also require the removal of the casing.

The casing is fixed to the boiler frame by 4 screws (see fig.6.1):

- 1 - Remove 2 screws located at the bottom of the appliance. To do this we suggest that the case door is open and a long pozi-drive n°2 screw driver is used;
- 2 - Remove 2 screws located on the front of the boiler, under the case door.
Use the same screw driver as above;
- 3 - Remove the case by pulling upwards and forwards;
- 4 - Remove 2 screws at the top of control panel using the same screw driver as above.
Support the panel whilst lowering.

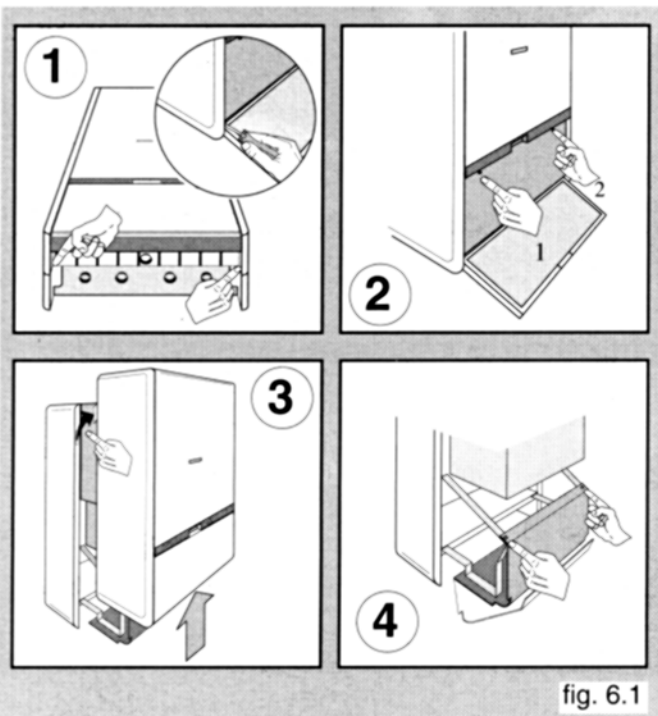

Removing the sealed chamber cover

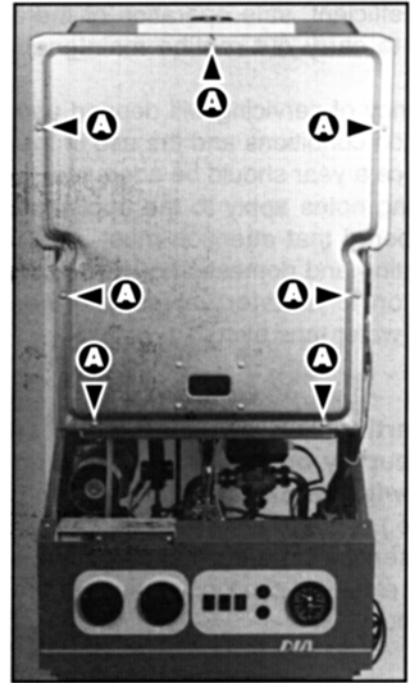

To remove the cover, remove fig. 6.2 screws A (see fig. 6.2). Pull cover forward. When replacing cover ensure that the silicone seal is in good condition. If not replace the seal.

Opening combustion chamber

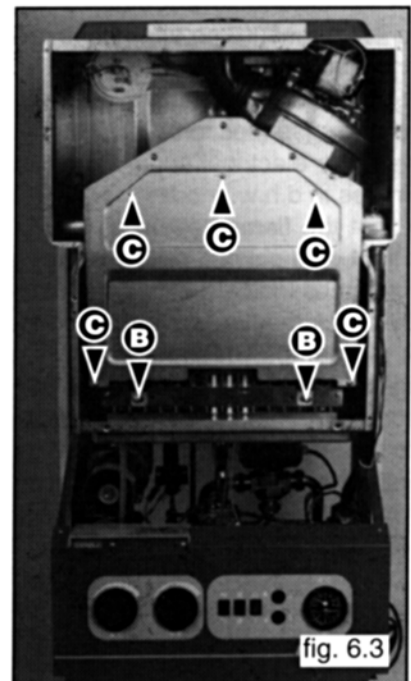

- 1 Remove screws B;
- 2 Remove screws C;
- 3 Pull forward and remove.

Servicing instructions

6.3 TO DRAIN THE MAIN CIRCUIT OF THE BOILER

- 1 Close c.h. flow and return cocks;
- 2 Release the manual vent cock (see fig.6.4);
- 3 Attach a small hose to the drainage cock "A" (see fig.6.5);
- 4 Open cock "A" and drain water from boiler.

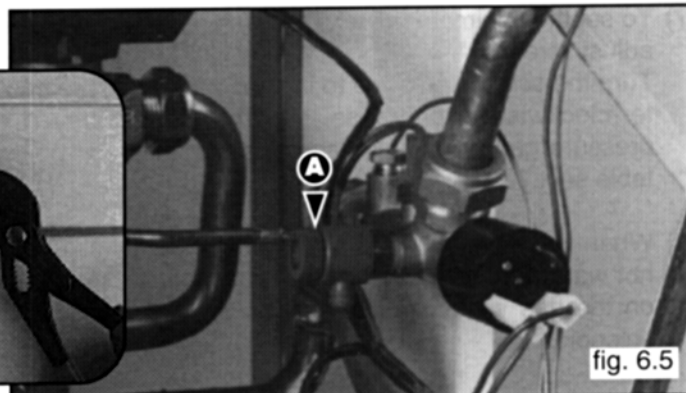

6.4 SETTING GAS PRESSURES

Setting the minimum and the maximum power of the boiler (see fig.6.7)

- 1) Check the special link (inside the P.C.B.) is correctly fitted in relation to the gas that is using (see fig.1).
- 2) Check that the supply pressure of gas valve is 20 mbar for natural gas.
- 3) To do this, remove the screw "B". Fit the pipe of the pressure gauge to the pressure connection of the gas valve. When you have completed this operation, fit the screw "B" securely into its housing to seal off the gas.
- 4) To check the pressure supplied by the gas valve, remove the screw "A". Fit the pipe of the pressure gauge to the pressure outlet of the gas valve. Disconnect the compensation pipe either from the gas valve or from the sealed chamber (see fig.6.6 a-b)

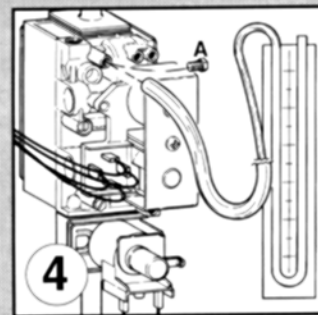
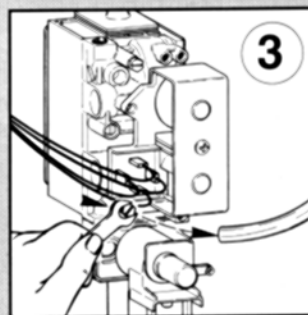
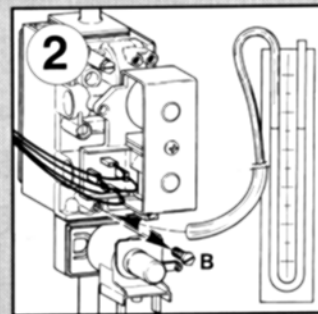
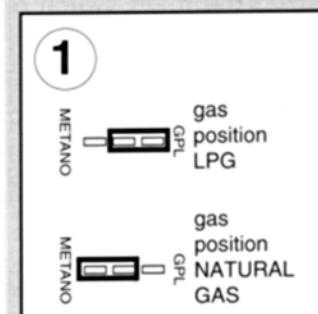
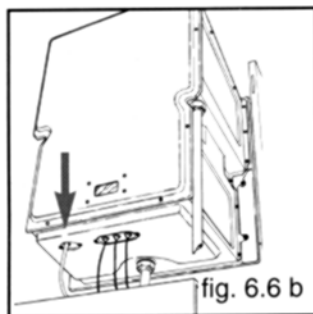
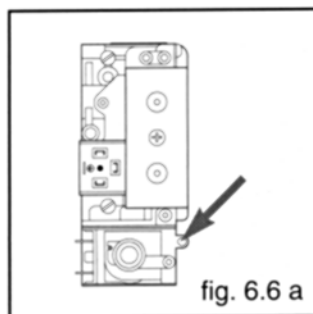

- 5) Set the ON/OFF switch to position <I> and the "summer/winter" switch to winter position III' ↗. To set the maximum power, turn on the hot water tap and allow hot water tap to run at a rate of about 8 litres/minute so that the main burner lights. Adjust screw "D" on the solenoid to set the pressure valve (displayed on the pressure gauge) corresponding to the maximum power (see table sect.1.2).



Servicing instructions

- 7) To set the minimum power, disconnect a supply terminal and adjust screw "C".
Turn the screw clockwise to increase the pressure and counter-clockwise to decrease the pressure (displayed on the pressure gauge) corresponding to the minimum power (see table sect.1.2).
- 8) When you have completed the above operations, turn off the hot water tap, re-connect the supply terminal to the solenoid on the gas valve and replace the cap on the screw of the solenoid.

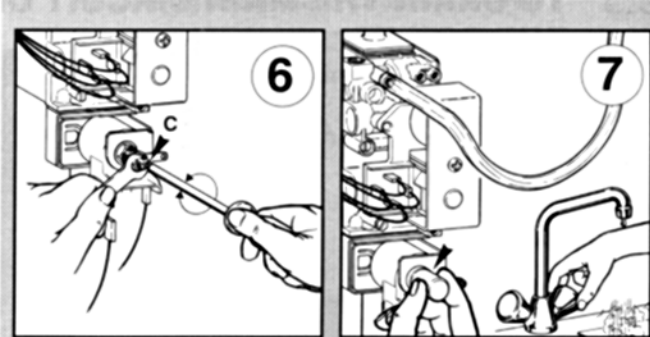

fig. 6.7

Setting the maximum heating circuit power (see fig. 6.8)

- 1) To set the maximum heating circuit power, place the ON/OFF switch to position <I> and the "summer/winter" switch to winter position III' 2. Turn the knob of the heating thermostat clockwise to maximum;
- 2) Lower control panel and find PCB on its internal left side. Remove the transparent cover and fit a cross-head screw driver in to the left side potentiometer. Turn clockwise to increase the pressure or counter-clockwise to reduce the pressure. Adjust the setting to the required heating pressure value (displayed on the pressure gauge), as indicated in the diagrams shown at the end of this manual.
- 3) Turn off the boiler by placing the main switch on "OFF" position.
Disconnect the detection electrode cable.
Turn on the boiler by placing the main switch to position "I" and sparks will come on.
Check the gas pressure on the pressure gauge which must be about 5 mbar .

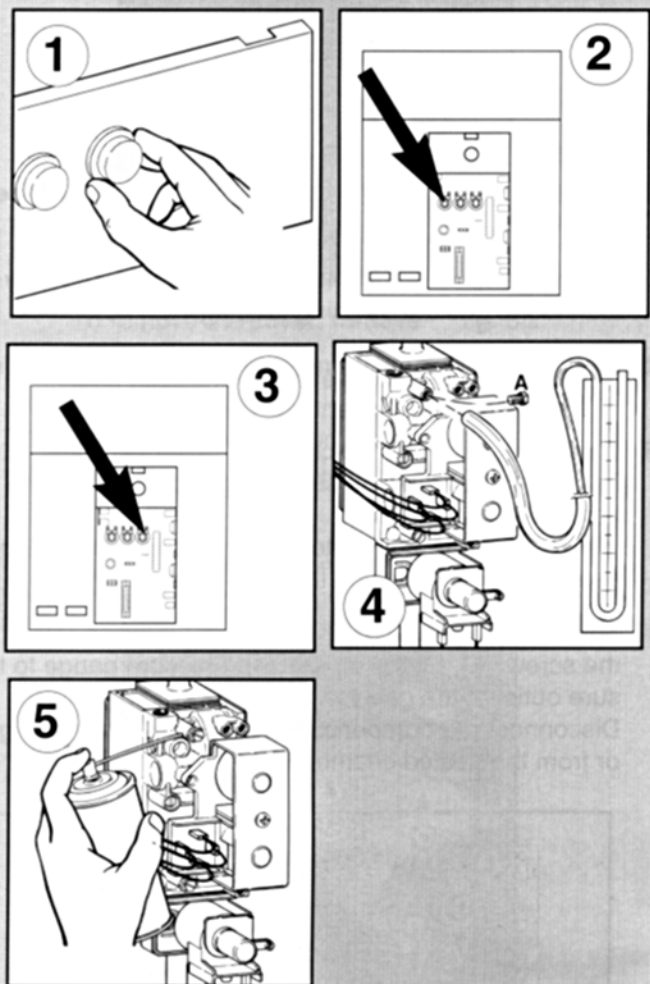

fig. 6.8

	NATURAL GAS (G20)	BUTANE GAS (G30)	PROPANE GAS (G31)
Recommended pressure for slow ignition	5 mbar - 1.95 in w.g.	18 mbar - 7.0 in w.g.	19 mbar - 7.4 in w.g.

If it is necessary adjust the slow ignition.

Fit a cross-head screw driver into the hole marked "REGULATION OF SLOW BURNER IGNITION" on the electronic P.C.B., through the potentiometer.

- 4) Remove the pipe of the pressure gauge and connect screw "A" to the pressure outlet in order to seal off the gas.
- 5) Carefully check the pressure outlets for gas leaks (valve inlet and outlet).

IMPORTANT!

Whenever you disassemble and reassemble the gas connections, always check for leaks using a soap and water solution.

Setting the delay of the ignition of the heating control

This appliance is equipped with a potentiometer which delays the ignition of the heating control and is situated on the P.C.B. (see the electric diagrams).

By adjusting the potentiometer, it is possible to change the time interval between the burner shutting down and its next ignition.

It is preset at 1 minute and can be adjusted from 0 to 2 minutes.

We could need this control in particular situations with continuous shutting down and ignitions of the main burner.

Servicing instructions

6.5 OVERHEAT THERMOSTAT

1 Ensure electricity is switched off at main isolator;

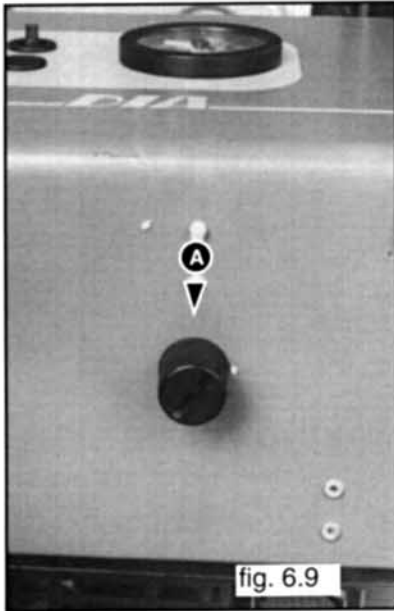

2 Remove cap "A" (see fig. 6.9);



3 Remove the securing nut "B" (see fig. 6.11);

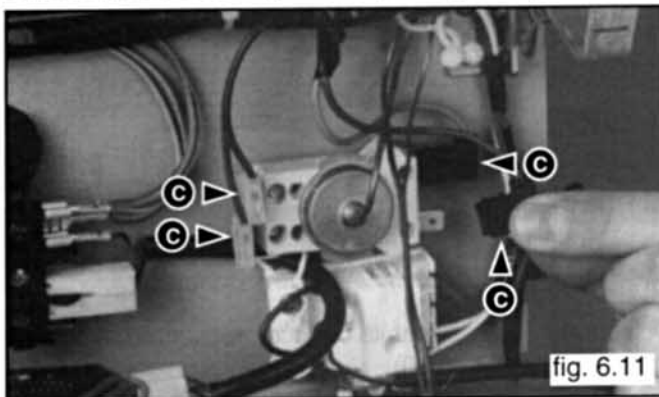

4 Lower control panel (sect. 6.2) and remove electrical connectors "C" (see fig. 6.11);

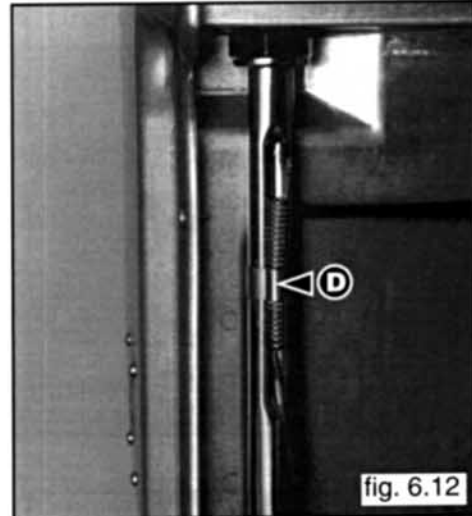

5 Remove spring "D" (see fig. 6.12).

6 Reassemble in reverse order.

6.6 REMOVING IGNITION ELECTRODES

1 Ensure electricity is switched off at main isolator

2 Lower control panel (sect. 6.2);

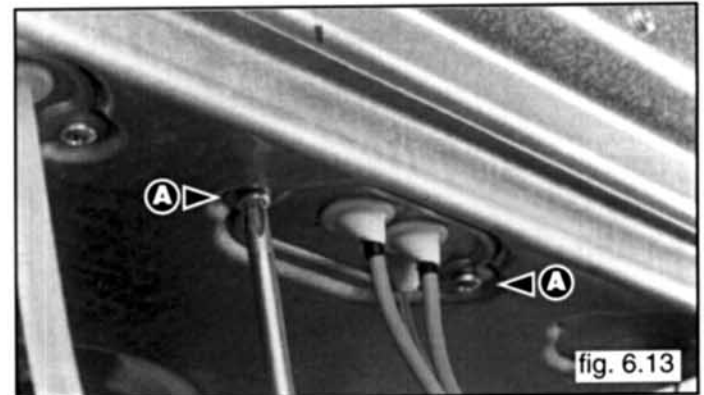

3 Remove screws "A" using a POZI-DRIVE No.2 star tip screw-drive (see fig. 6.13);

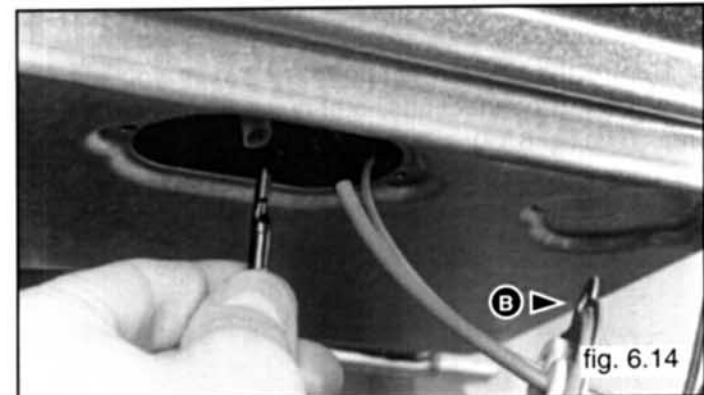

screw-drive (see fig. 6.13);

4 Slide the plate "B" and disconnect the cables pulling them downwards (see fig. 6.14);

Servicing instructions

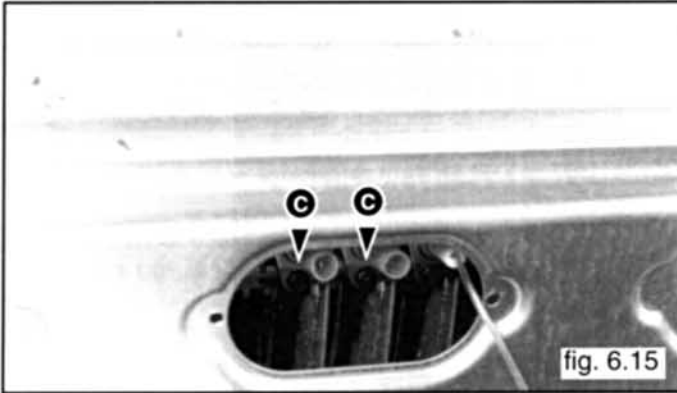

5 Remove screws "C" using a PHILLIPS No.2 star tip screwdriver (see fig. 6.15);

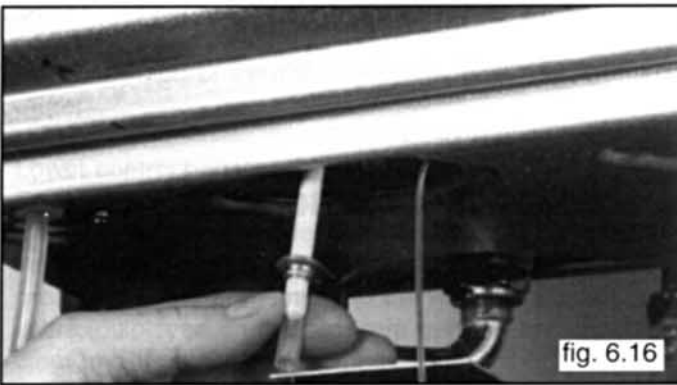

6 Slide the electrodes gently downwards (see fig. 6.16);

To mount, repeat the steps in reverse order, paying particular attention to the following:

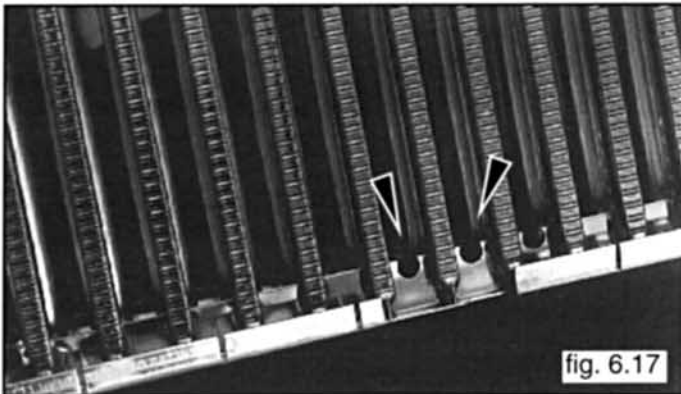

a Centre the second support hole which you will find between the connections, otherwise the electrode may break (see fig. 6.17);

b Check that the cables have in fact been connected, since friction and interference are often misleading;

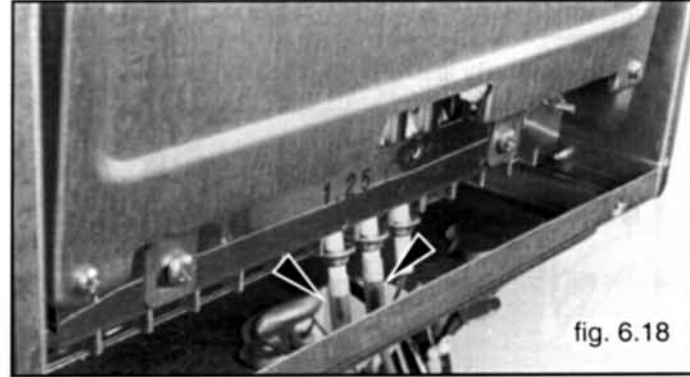

c Check that the transparent silicone pipe covers the cable-electrode connection point adequately (see fig. 6.18);

6.7 REMOVING FLAME SENSOR

1 Ensure electricity is switched off at main isolator;

2 Lower control panel (sect. 6.2);

3 Remove screws "A" using a POZI-DRIVE No.2 star tip screw-driver (see fig. 6.13);

4 Slide plate "B" downwards (see fig. 6.14);

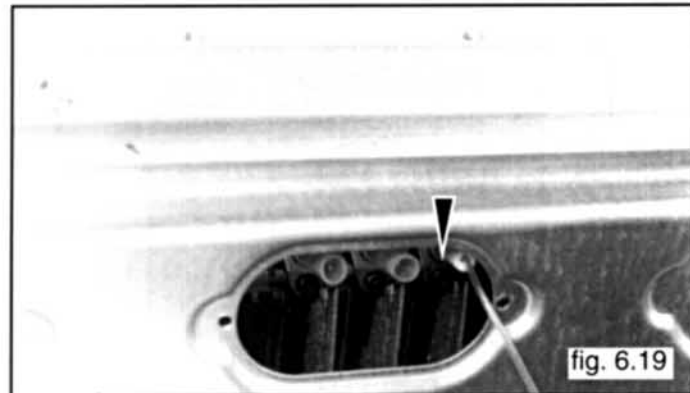

5 Remove the screw using a PHILLIPS No.2 star tip screw-driver (see fig.6.19);

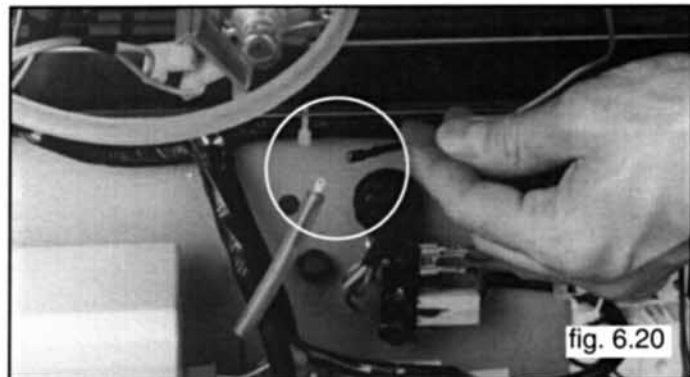

6 Slide the electrode downwards very gently;

7 Disconnect the cable at its only connection point close to the p.c.b. (see fig. 6.20);

When you reassemble the part, follow the steps in reverse

Servicing instructions

order ensuring that you centre the second support hole between the connection, otherwise the electrode may break.

6.3 REPLACING P.C.B.

- 1 Ensure electricity is switched off at main isolator.
- 2 Lower control panel.
- 3 Disconnect each electrical connection (see fig. 6.21). (Remembering detection connection as well).



- 4 Remove control knobs (see fig. 6.22 a-b).

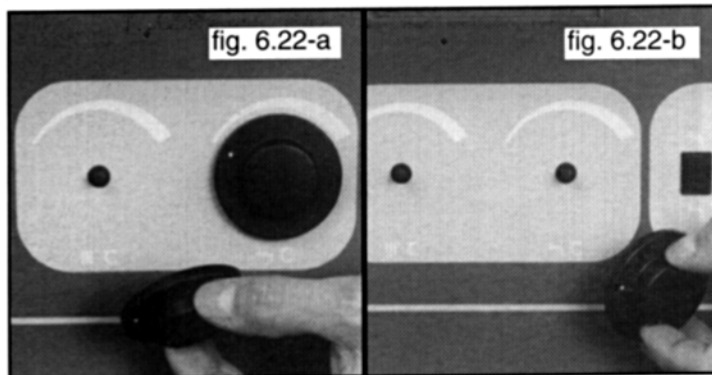

- 5 Remove n°2 screws at the bottom of the control panel (see fig. 6.23).

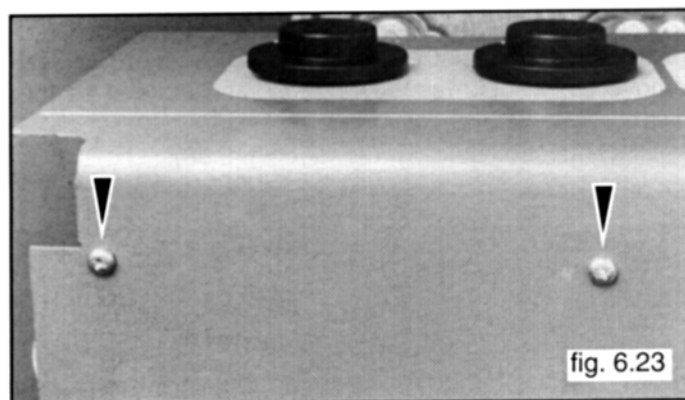

- 6 Remove n°2 screws as on fig. 6.24.

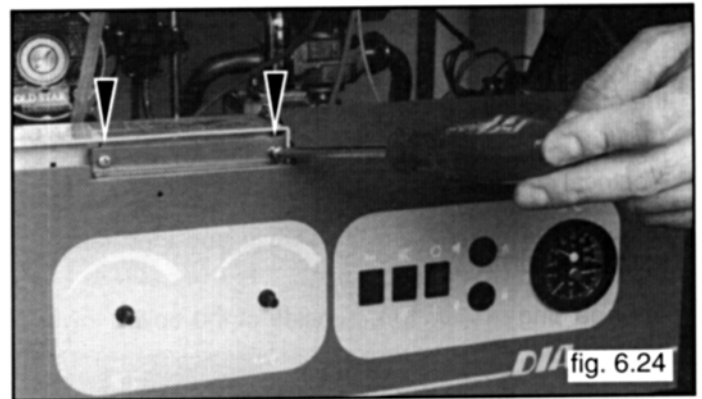

- 7 When removing PCB pay particular attention to plastic shafts at rear of PCB.
- 8 Remove shafts by pulling.
- 9 Remove PCB support plate by removing n°2 screws as on fig. 6.25.

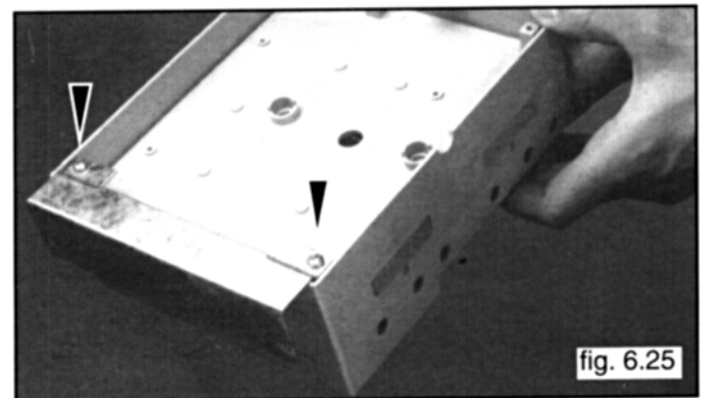

Replace the new PCB assembling in reverse order taking particular care with the plastic shafts. Each shaft housing is connected to a potentiometer and could be damaged by force.

Servicing instructions

6.9 REPLACE THE DOMESTIC HOT WATER TEMPERATURE PROBE

- 1 Make sure that electricity has been switched off at the main isolator
- 2 Remove the cover in order to gain access to the electrical components of the storage tank.
- 3 Remove the probe from the sleeve and then take it out through its access.
- 4 After gaining access to the inside of the boiler, lower the control panel.
- 5 Loosen the clamps indicated in the fig. 6.26 and remove the burned out probe.

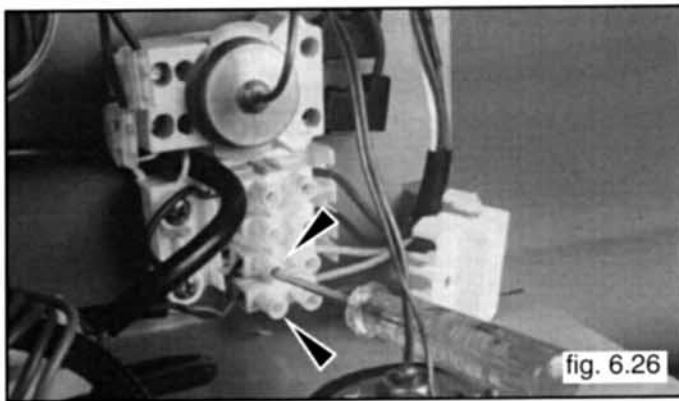

fig. 6.26

- 6 To replace the probe, follow these same instruction in the reverse order

6.10 REMOVING C.H.W. SENSOR PROBE

- 1 Ensure electricity is switched of at main isolator.
- 2 Lower control panel (sect. 6.2);

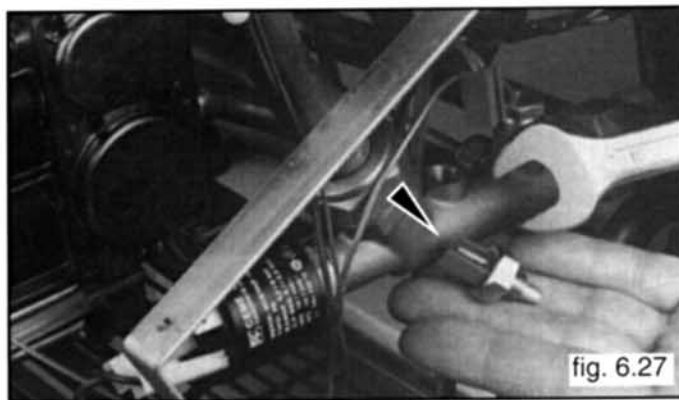

fig. 6.27

- 3 Drain boiler (sect. 6.3);
- 4 Disconnect the electric connector by pulling up
- 5 Unscrew the sensor probe using a 15 mm open ended;
- 6 Reassemble in reverse order.

6.11 DIVERTER VALVE (MOTORIZED)

In the case of the diverter valve failur it is possible to replace the valve or motor seprately:

- 1 Make sure that the power supply has been turned off at the main isolator.
- 2 Lower the control panel.
- 3 Unfasten the connector "A" (see fig. 6.28).



fig. 6.28

4. Press the button indicated in figure 6.29 and turn the motor in the counter-clockwise direction at the same time.

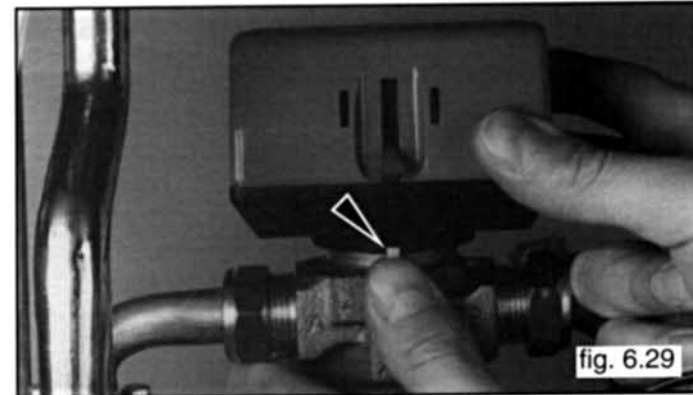

fig. 6.29

5. To mount the new motor follow the same procedure in the reverse order.

6.12 MAIN FLOW SWITCH

If the problem is just on the electrical section, do not remove the whole main flow switch, but proceed as follows:

- 1 Disconnect electrical wires (see fig. 6.30).

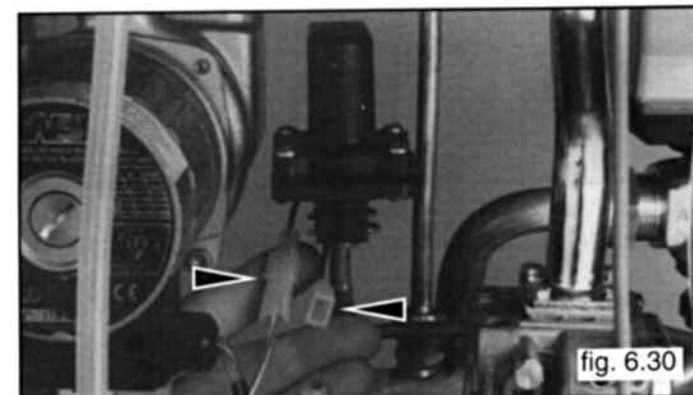

fig. 6.30

Servicing instructions

- 2 remove the switch box by pulling firmly towards the back of the boiler (see fig. 6.31).

- 3 replace the switch box and reassemble following the reverse order.

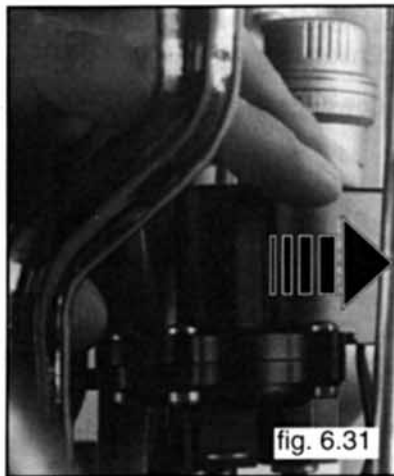

fig. 6.31

To replace the whole main flow switch, after disconnecting electrical wires:

- 1 Remove spring clips using bull nosed pliers (see fig.6.32).

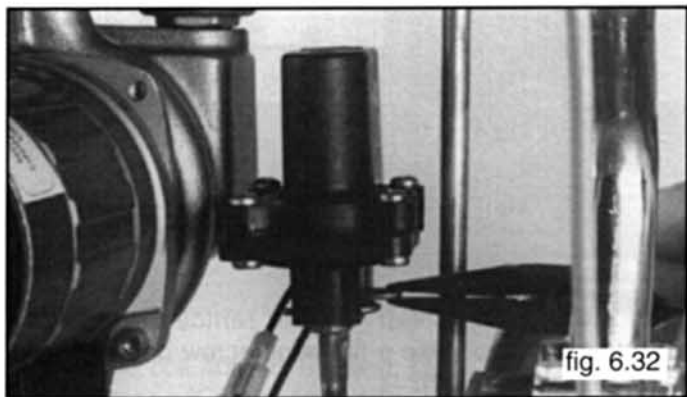

fig. 6.32

- 2 Pull upwards firmly.
Reassemble in the reverse order

Warning:

on reassembling a new main flow switch ensure that

the "+" hydraulic connection is connected to the longer pipe (see fig. 6.33).

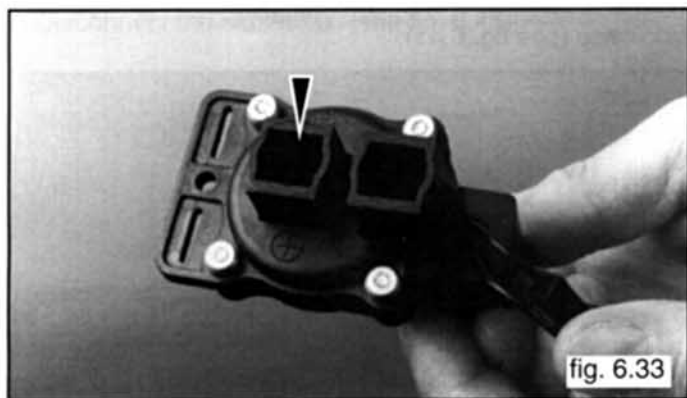

fig. 6.33

6.13 BURNER AND INJECTORS

- 1 Ensure electricity is switched off at main isolator;
- 2 Lower control panel (sect. 6.2);
- 3 Remove all electrodes (sect. 6.7 and 6.8);

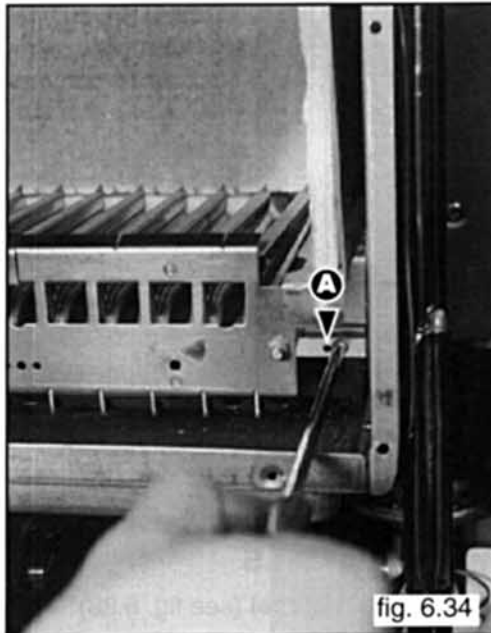

fig. 6.34

- 4 Remove the 4 screws "A" using a PHILLIPS No.2 star tip screw-driver (see fig. 6.34);

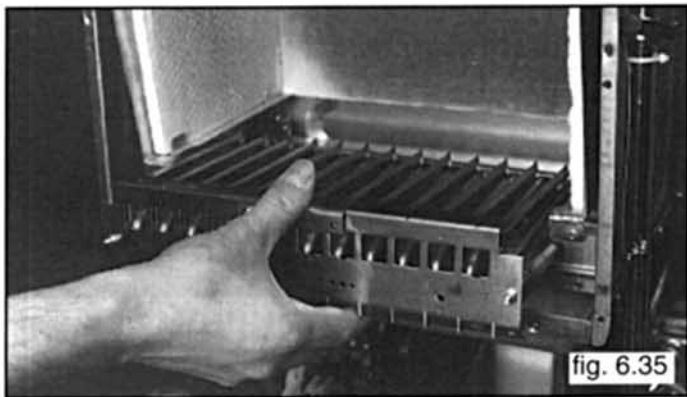

fig. 6.35

- 5 Remove the burner (see fig. 6.35);

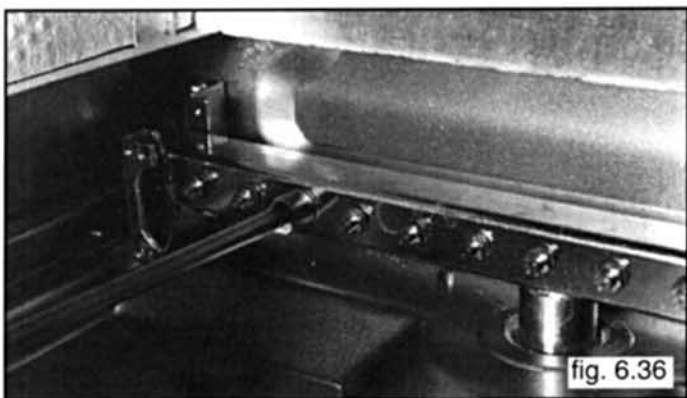

fig. 6.36

- 6 Remove the nozzles using a No.7 socket spanner.
Keep the washers (see fig. 6.36);

Reassemble in reverse order.

Servicing instructions



fig. 6.37

NOTE: When you are replacing the nozzles to convert the appliance for use with a different type of gas, remember to replace the existing data plate (under the instrument panel) with the plate supplied in the modification kit (see fig. 6.37).

6.14 INSULATION PANELS

To replace the front insulation panel (see fig. 6.38)

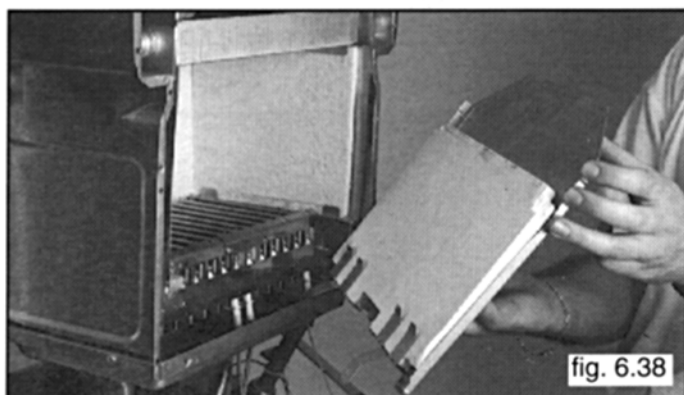

fig. 6.38

1 To remove the combustion chamber cover (sect. 6.2), hold the panel firmly and pull downwards. No other tool is required.

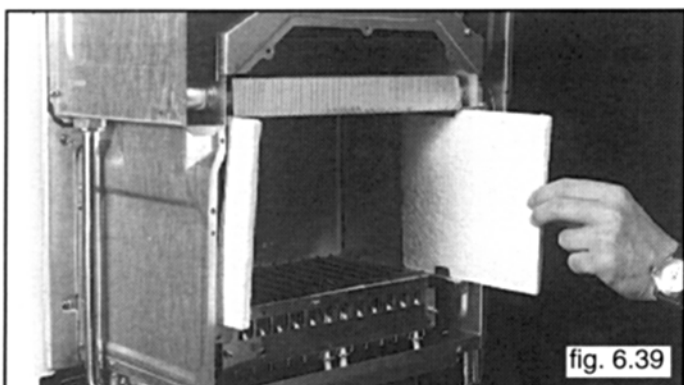

fig. 6.39

To replace the side insulation panel (see fig. 6.39)

- 1 Remove the combustion chamber cover (sect. 6.2);
- 2 Slide the side insulation panels forward;
- 3 Replace in reverse order.

To replace the back insulation panel

- 1 Remove the combustion chamber cover (sect. 6.2);
- 2 Dismount the hood together with the fan (sect. 6.19);
- 3 Dismount the primary exchanger (sect. 6.21);
- 4 Pull the panel up and slide it out;
- 5 Reassemble in reverse order.

6.15 GAS MODULATOR CARTRIDGE

- 1 Ensure electricity is switched off at main isolator;
- 2 Lower control panel (sect. 6.2);

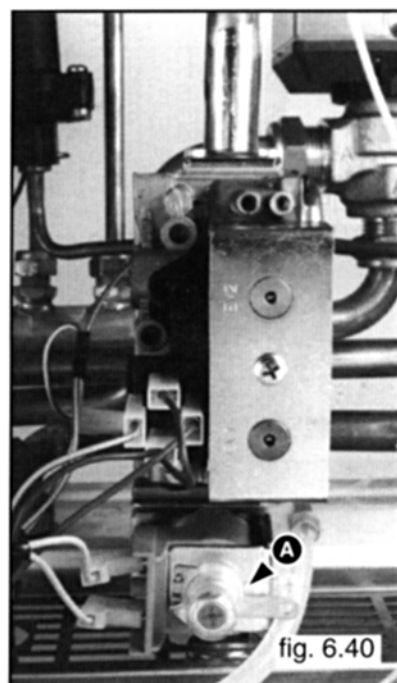

fig. 6.40

- 3 Turn the protection cap "A" and remove it from the adjustment control. Use a flat-edge screw driver to help removal (see fig. 6.40);

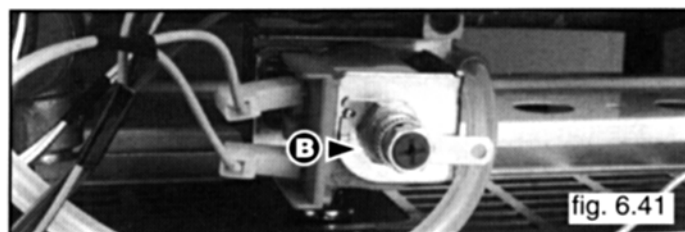

fig. 6.41

- 4 With a 14 mm spanner turn the cartridge "B" counter-clockwise (see fig. 6.41);

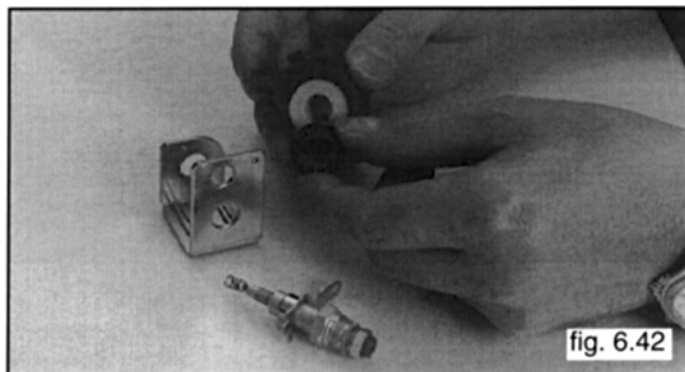

fig. 6.42

- 5 Remove the cartridge, but be very careful not to lose the internal components (see fig. 6.42);
- 6 Reassemble in reverse order.

Servicing instructions

6.16 GAS MODULATOR COIL

- 1 Ensure electricity is switched off at main isolator;
- 2 Disconnect the two cables;
- 3 Lower the control panel (sect. 6.2);
- 4 Remove the gas modulator cartridge as explained in sect. 6.15;

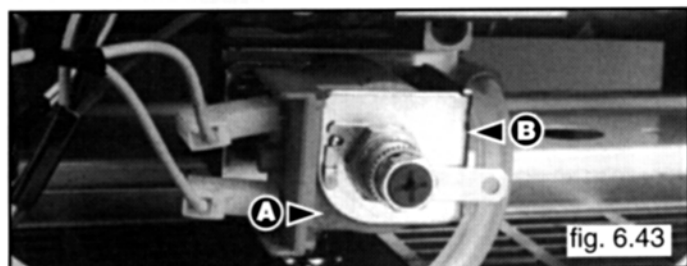

- 5 Slide the coil "A" and its housing from the valve (see fig. 6.43);
- 6 Remove the plate "B" (see fig. 6.43);



- 7 Slide the coil from its housing, being very careful not to lose spring "C" (see fig. 6.44);
- 8 Reassemble in reverse order.

6.17 ON-OFF OPERATOR COILS

- 1 Ensure electricity is switched off at main isolator;
- 2 Lower the control panel (sect. 6.2);

To remove the TANDEM operator coil

- 3 Disconnect the cables "B" (see fig. 6.46);
- 4 Unscrew the screw "A" and slide the TANDEM coils with its housing from the valve (see fig. 6.46);
- 5 Reassemble in reverse order.

6.18 GAS VALVE

- 1 Ensure electricity is switched off at main isolator;
- 2 Remove the cover and lower control panel (sect. 6.2);
- 3 Disconnect all the cables "B" (see fig. 6.46);
- 4 Remove the bottom plastic grid.
- 5 Remove the two screws "D" (see fig. 6.47) by a Pozidrive n°2 star trip screw driver;

- 6 Release the top nut "C" using a 30 mm open ended spanner (see fig. 6.45);
- 7 Reassemble in reverse order.

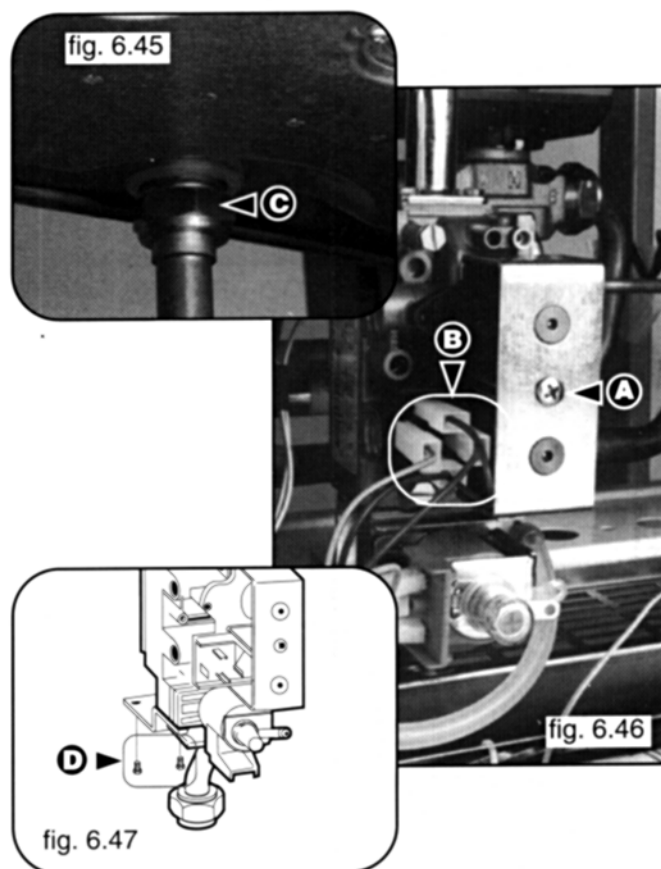

6.19 REMOVING THE FAN

- 1 Ensure electricity is switched off at main isolator;
- 2 Remove sealed chamber cover (sect. 6.2);

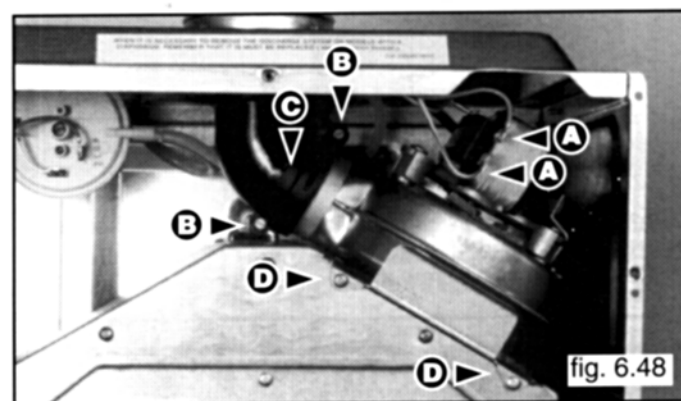

- 3 Disconnect electrical connections "A" (see fig. 6.48);
- 4 Remove screws "B" using a flat tip screw-driver with a tip of at least 6.5 mm (see fig. 6.48);
- 5 Remove clamp "C" (see fig. 6.48);
- 6 Remove screws "D" (see fig. 6.48);
- 7 Pull fan forward and remove;

Servicing instructions

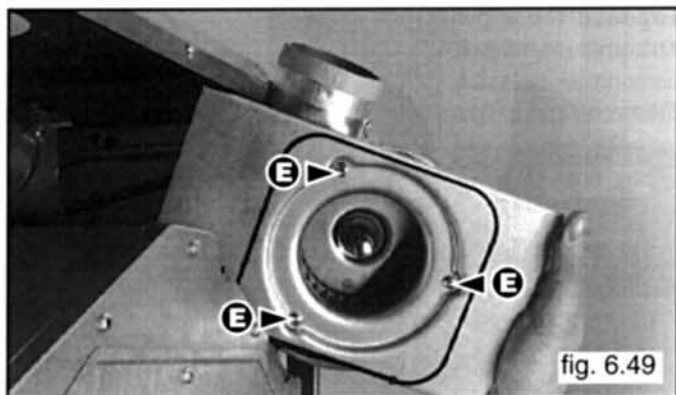

- 8 Remove screws "E" using a POZI-DRIVE No.2 star tip screw-driver (see fig. 6.49);
- 9 Remove fan from mounting plate;
- 10 Reassemble in reverse order.

Ensure that the silicone seal is in good order.
If necessary replace the seal.

6.20 AIR PRESSURE SWITCH

- 1 Ensure electricity is switched off at main isolator;
- 2 Disconnect every electrical connections (A;B;C) (see fig. 6.50);

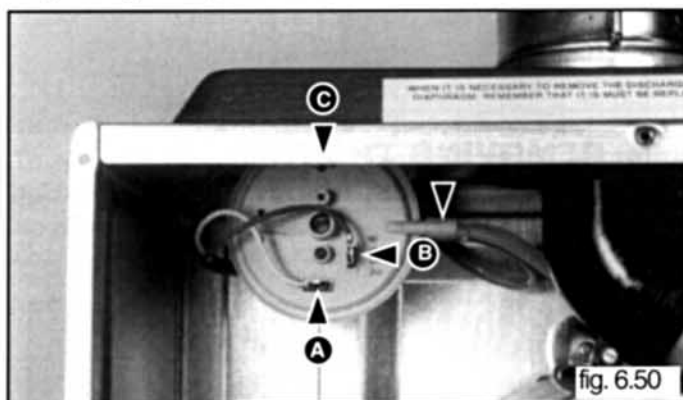

- 3 Disconnect silicon pipes at connection point as shown by arrow on fig. (see fig.6.50);
- 4 Remove screws D on the top of the sealed chamber as shown on fig.(see fig. 6.51);
Use a n°2 star tip screw driver

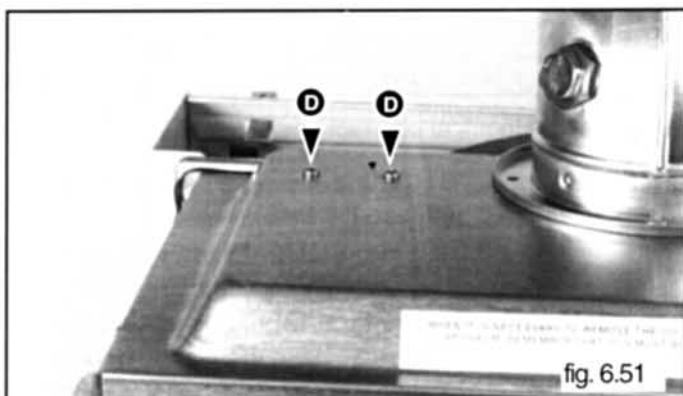

- 5 Remove screws which fix the air pressure switch to its support plate by a n°2 star tip screw driver (see fig.6.52)



Reassemble in reverse mode.

WARNING!

Each type of A.P. switch has its own screws.
Different screws could compromise their normal operating.

6.21 MAIN HEAT EXCHANGER

- 1 Ensure electricity is switched off at main isolator;
- 2 Drain boiler (sect. 6.3);
- 3 Remove sealed chamber cover and open the combustion chamber (sect. 6.2);
- 4 To remove the front panel of the flue hood, unscrew the 3 screws "A" using a POZI-DRIVE No.2 star tip screw-driver (see fig. 6.53);

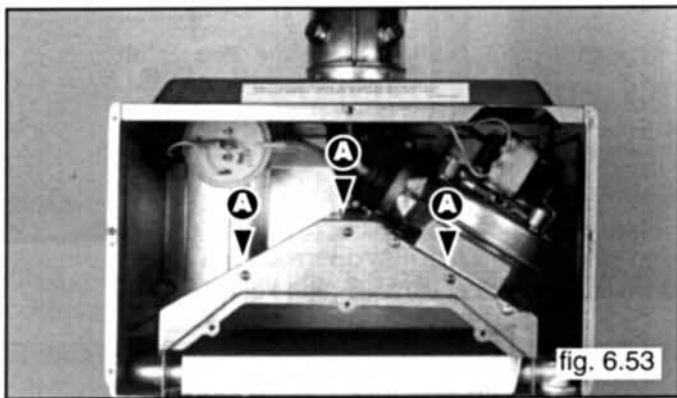

- 5 Remove the front panel of the hood "B" (see fig. 6.54);

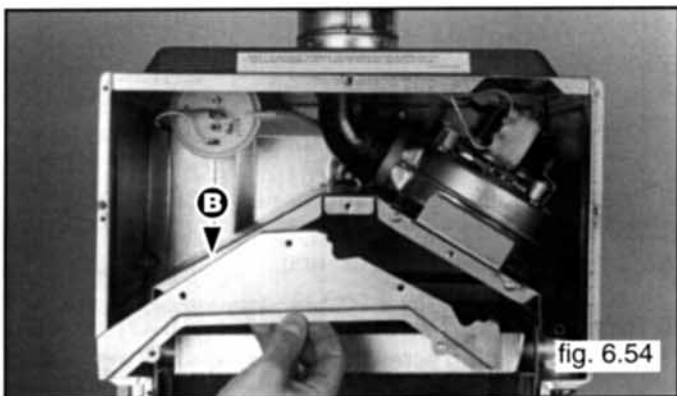

Servicing instructions

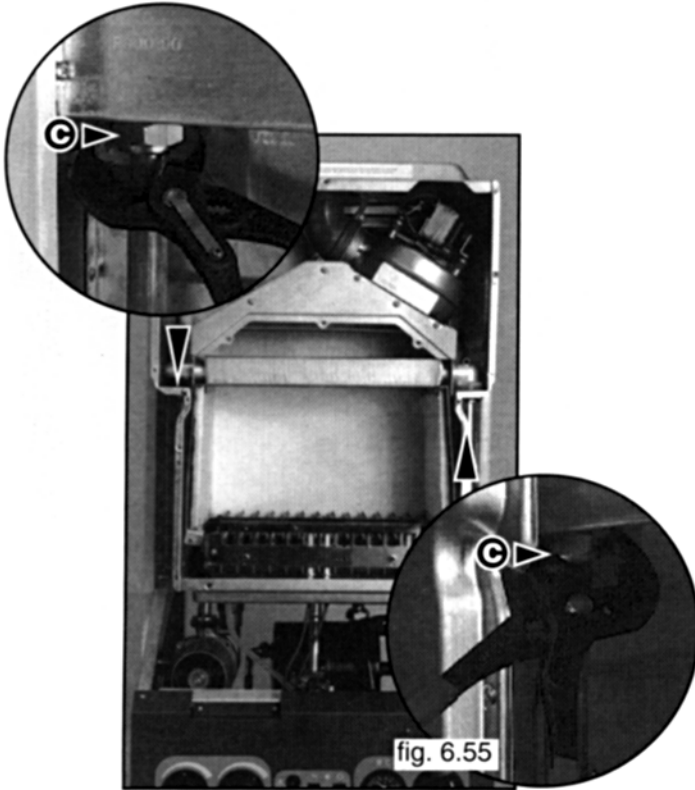

6 Release nuts "C" (see fig. 6.55);

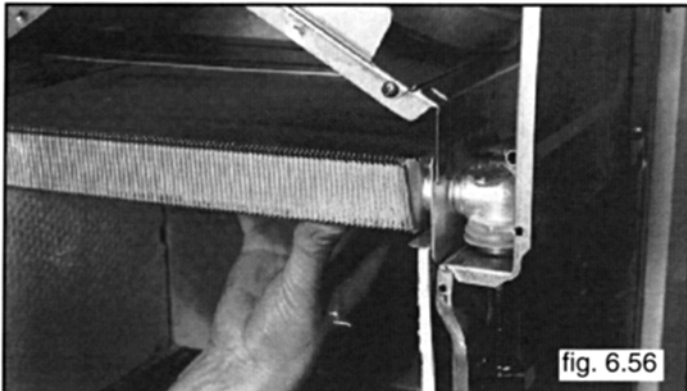

7 Lift the exchanger in order to release the attachments from their housing (see fig. 6.56);

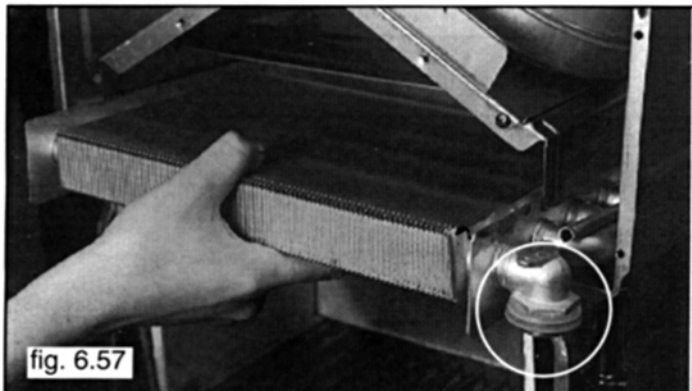

8 Pull it straight out (see fig. 6.57);

9 Keep the gaskets (see fig. 6.57).

Reassemble in reverse order.

6.22 AUTOMATIC AIR PURGER

1 Ensure electricity is switched off at main isolator;

2 Drain boiler (sect. 6.3);

3 Unscrew valve "A" (see fig. 6.58);

4 Reassemble in reverse order.

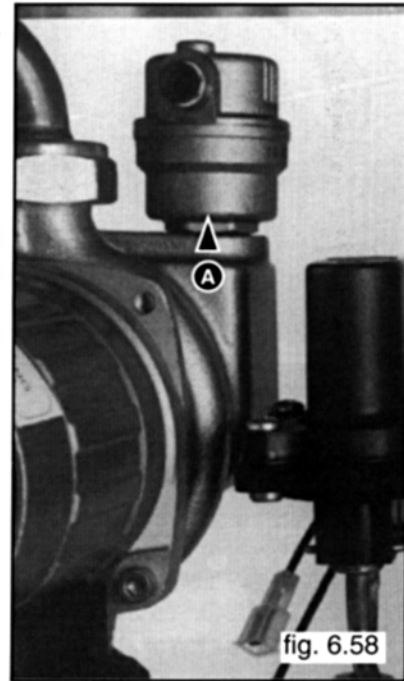

6.23 PUMP

1 Ensure electricity is switched off at main isolator;

2 Drain boiler (sect. 6.3);

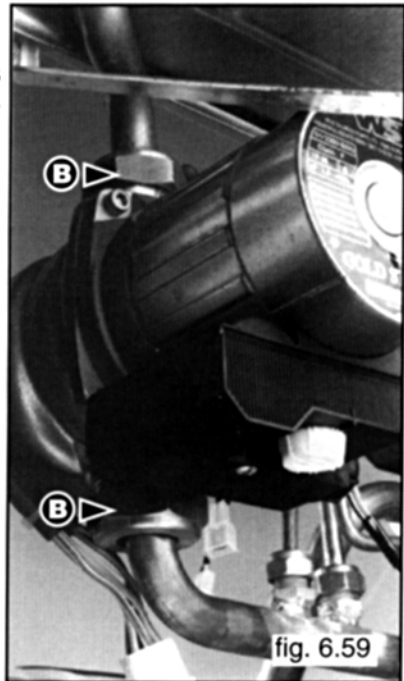

3 Release nuts "B" using a 36 mm open ended (see fig. 6.59);

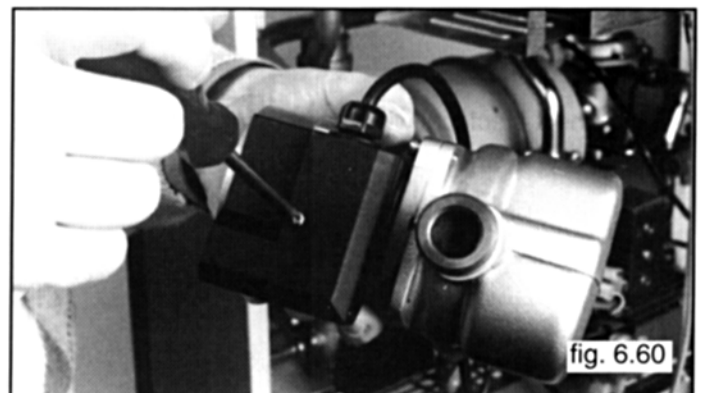

Servicing instructions

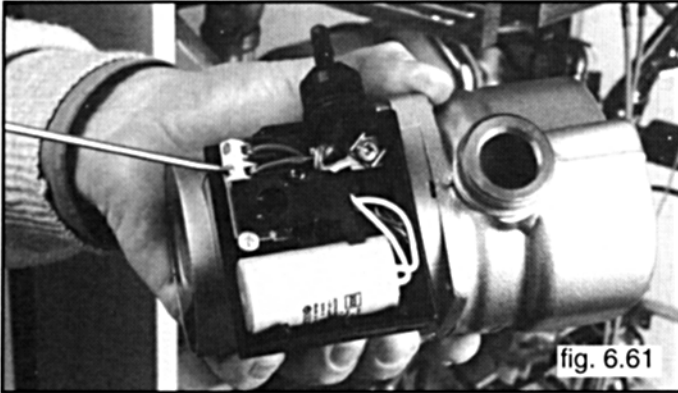

fig. 6.61

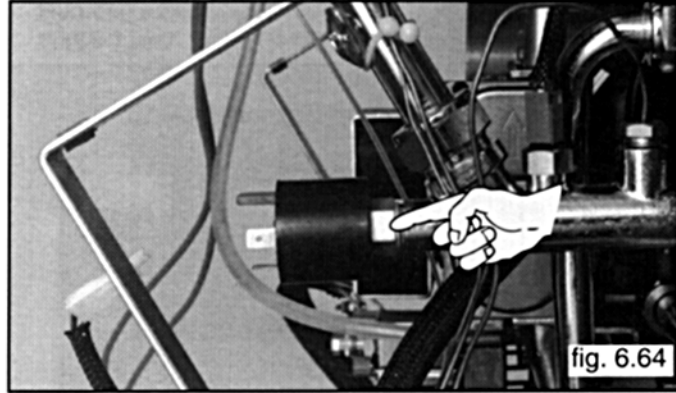

fig. 6.64

- 4 Remove pump pressure switch using a 17mm open ended (see fig.6.64);
- 5 Reassemble in reverse order.

6.25 TEMPERATURE PRESSURE GAUGE

- 1 Ensure electricity is switched off at main isolator;
- 2 Remove the cover and lower the control pane (sect. 6.2);
- 3 Drain boiler (sect. 6.3);

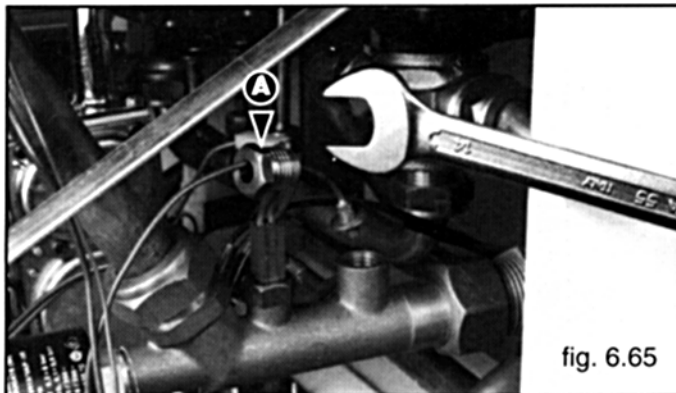

fig. 6.65

- 4 Release coupling "A" using a 14 mm open ended (see fig.6.65);
- 5 Remove the clamps joining the capillary to the electric cables;

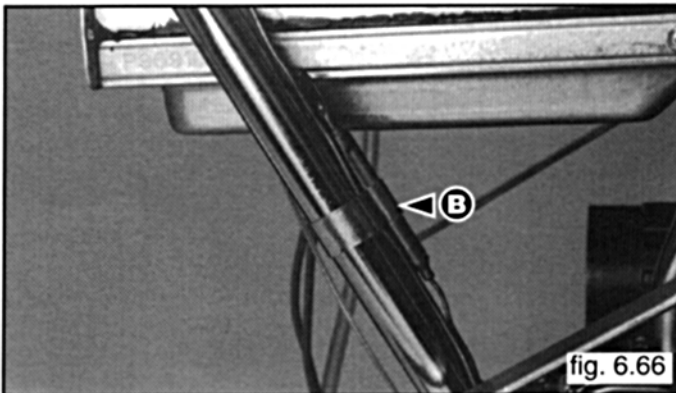

fig. 6.66

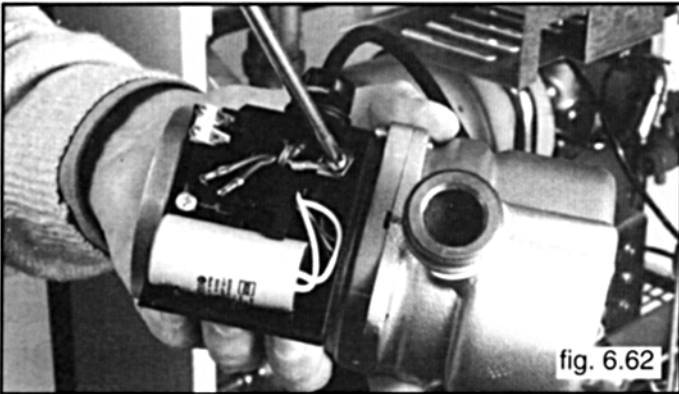

fig. 6.62

- 4 Disconnect electrical connections (see fig. 6.60,6.61, 6.62).
- 5 Reassemble in reverse order.

6.24 PUMP PRESSURE SWITCH

- 1 Ensure electricity is switched off at main isolator;
- 2 Drain boiler (sect. 6.3);

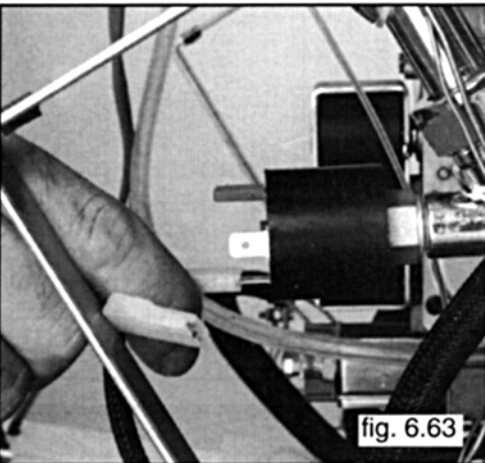

fig. 6.63

- 3 Disconnect electrical wires (see fig. 6.63);

Servicing instructions

the clamps joining the capillary to the electric cables;

- 6 Remove spring "B" (see fig.6.66);

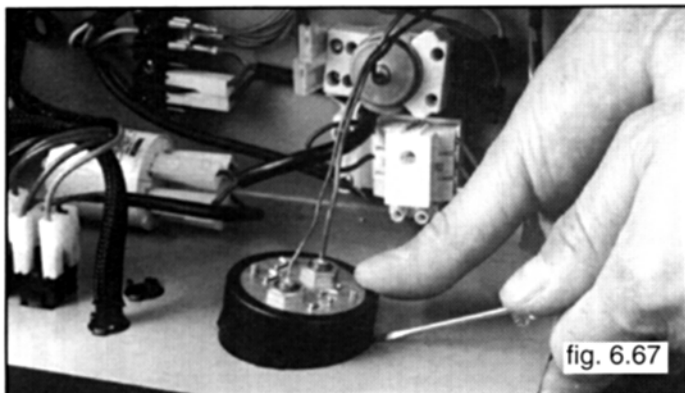

- 7 Push on the instrument from the interior to the exterior (see fig. 6.67);

- 8 Reassemble in reverse order.

6.26 EXPANSION VESSEL

- 1 Ensure electricity is switched off at main isolator;
- 2 Drain boiler (sect. 6.3);
- 3 Disconnect flue;
- 4 Remove nut "A" away from the expansion vessel (see fig.6.73);

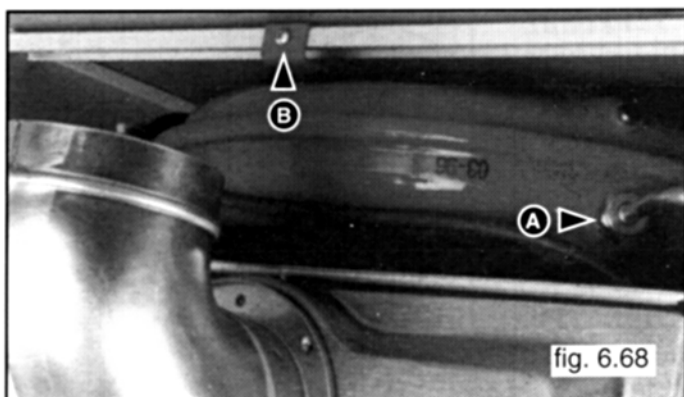

- 5 Remove screw "B" using a POZI-DRIVE No.2 star tip screw driver (see fig.6.68);

- 6 Lift expansion vessel up from the boiler;

- 7 Reassemble in reverse order.

If there is not adequate clearance the boiler must be removed from the wall before the removal procedure can be carried out.

6.27 SAFETY VALVE

- 1 Ensure electricity is switched off at main isolator;
- 2 Lower control panel (sect. 6.2);
- 3 Drain boiler (sect. 6.3);

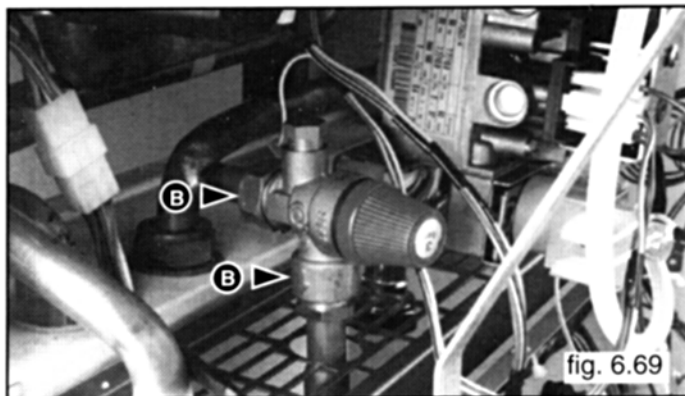

- 4 Loosen nuts B (see fig.6.69);

- 5 Remove valve;

- 6 Reassemble in reverse order.

7 ELECTRIC DIAGRAMS

7.1 ELECTRICAL CONNECTION

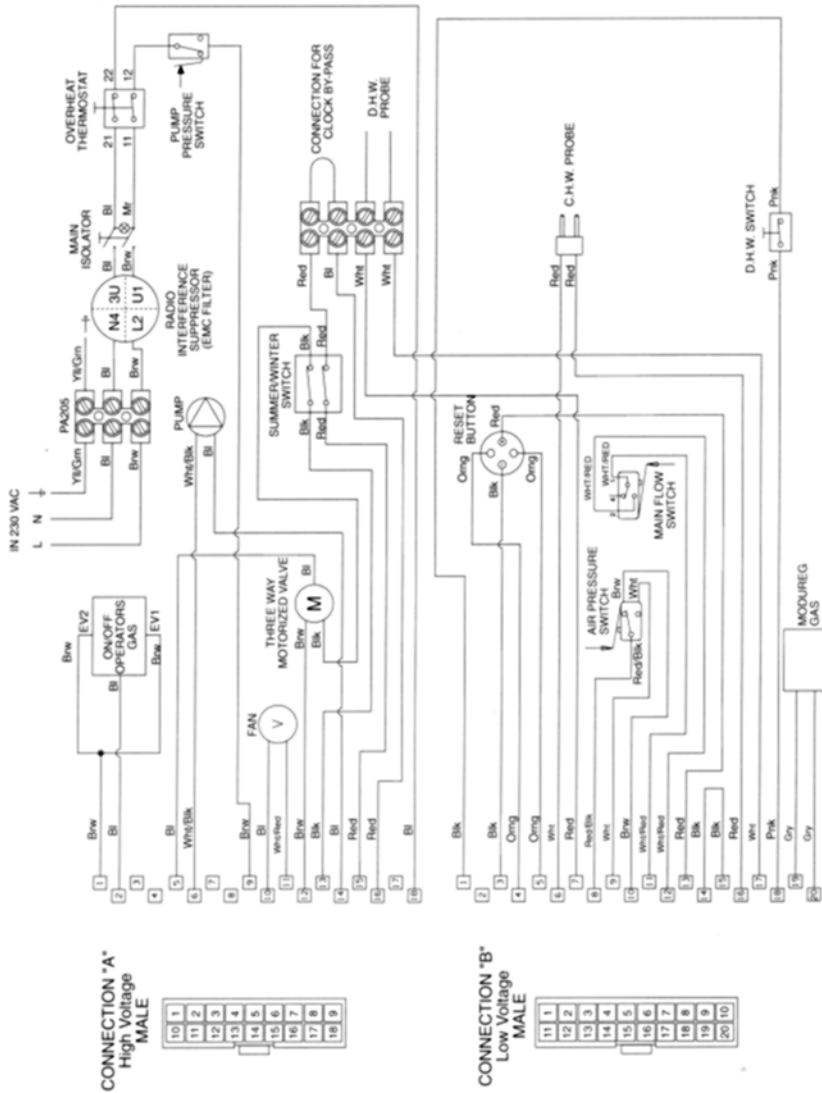

COLOUR

- Bl = Blue
- Red = Red
- Brw = Brown
- Blk = Black
- Gry = Grey
- Vio = Violet
- Wht = White
- Pnk = Pink
- Grn = Green
- Orng = Orange
- Yll/Grn = Yellow/Green
- Wht/Blk = White/Black
- Wht/Red = White/Red
- Red/Blk = Red/Black

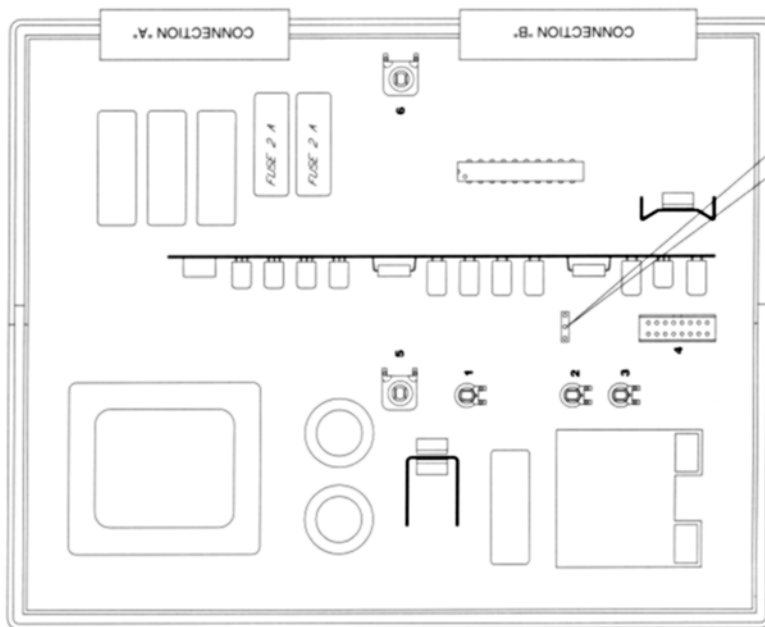

- 1 IGNITION DELAY CONTROL ON HEATING MODE
- 2 MAXIMUM HEATING CIRCUIT POWER CONTROL
- 3 SLOW IGNITION CONTROL
- 4 TCS CONNECTOR
- 5 C.H.W. POTENTIOMETER
- 6 D.H.W. POTENTIOMETER

7 ELECTRIC DIAGRAMS

7.2 FUNCTIONAL FLOW CONNECTION

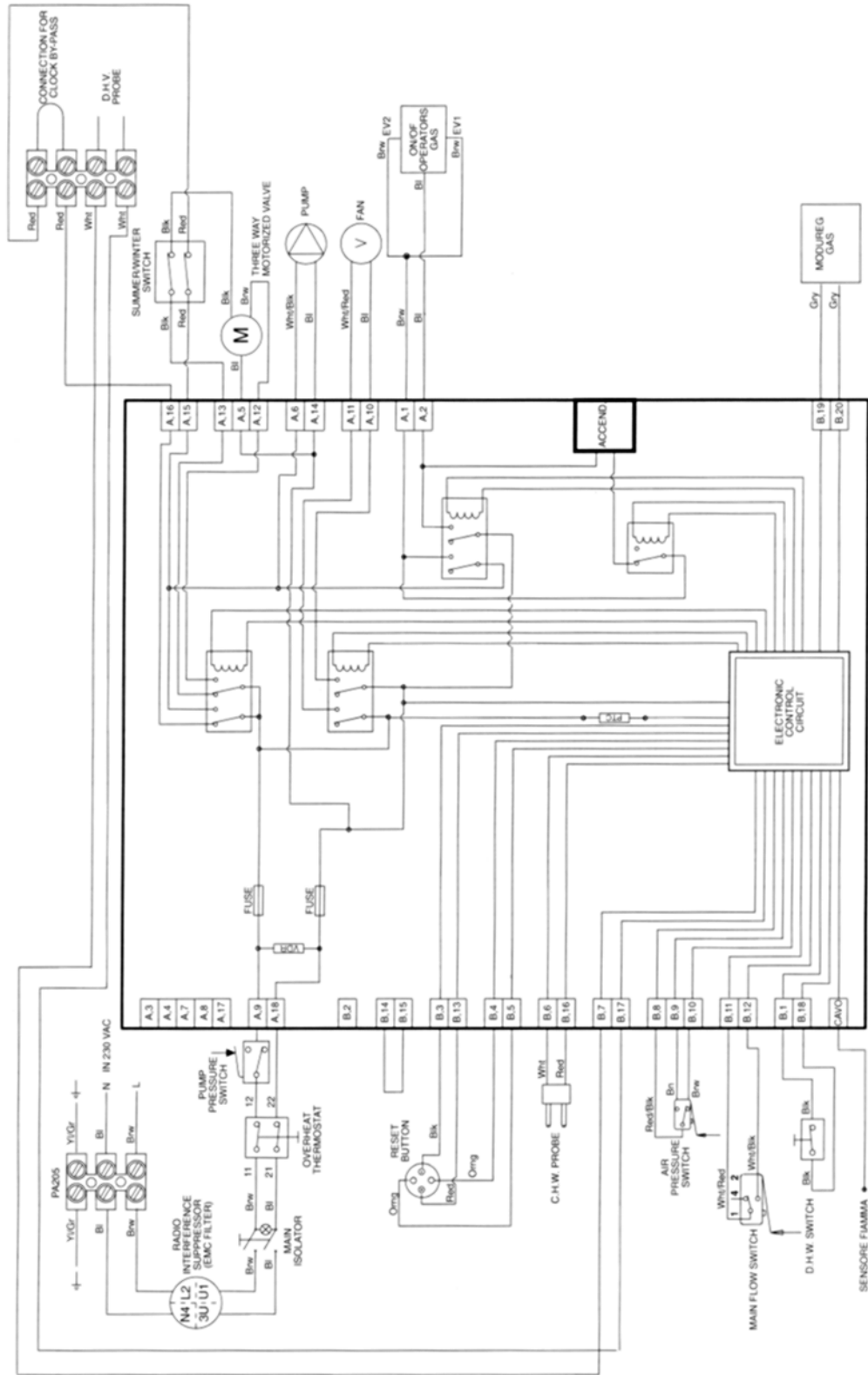

COLOUR

- Bl = Blue
- Red = Red
- Brw = Brown
- Blk = Black
- Gry = Grey
- Vio = Violet
- Wht = White
- Pnk = Pink
- Grn = Green
- Org = Orange
- Yll/Grn = Yellow/Green
- Wht/Blk = White/Black
- Wht/Red = White/Red
- Red/Blk = Red/Black

SHORT SPARE PARTS LIST

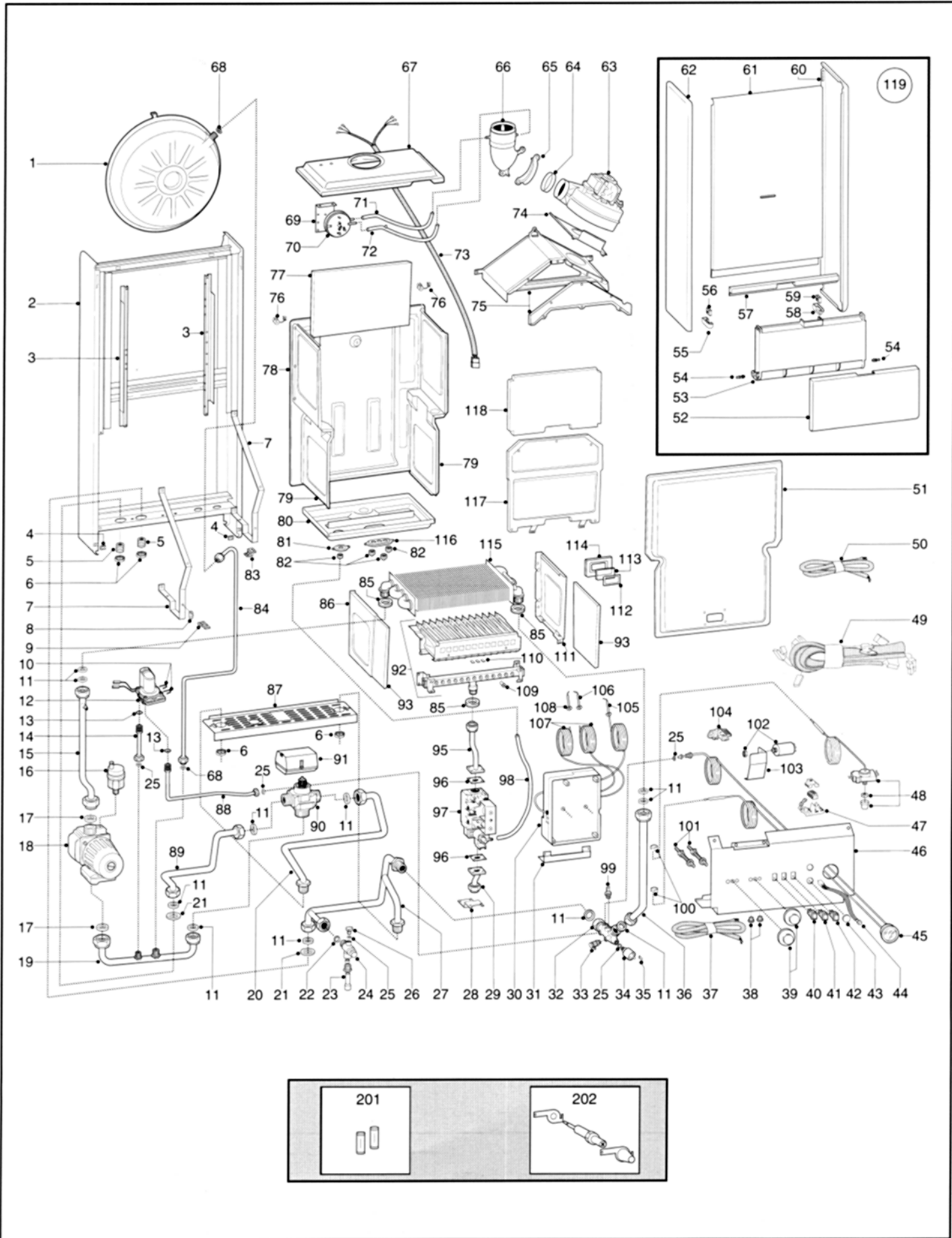

CONTROL PANEL

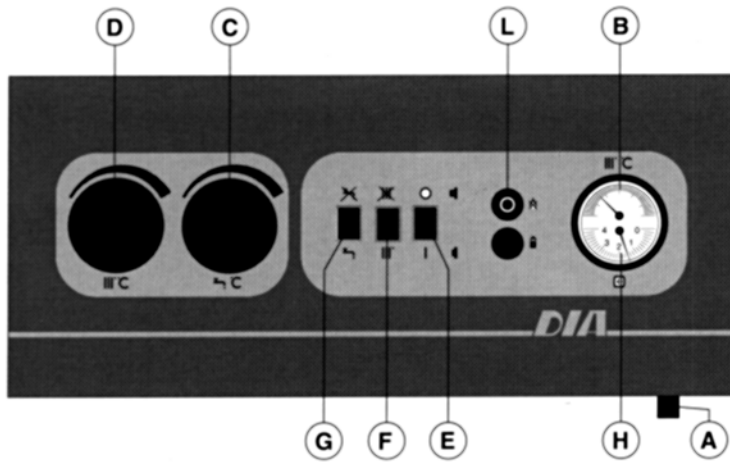

- A:** Safety thermostat reset
- B:** Central heating flow temperature gauge
- C:** Domestic hot water temperature control
- D:** Central heating temperature control
- E:** On/off switch with neon light
- F:** Central heating mode on/off switch
- G:** domestic hot water mode on/off switch
- H:** Water pressure gauge
- L:** Red warning light

FIGURA

RESIDUAL HEAD OF THE CIRCULATOR

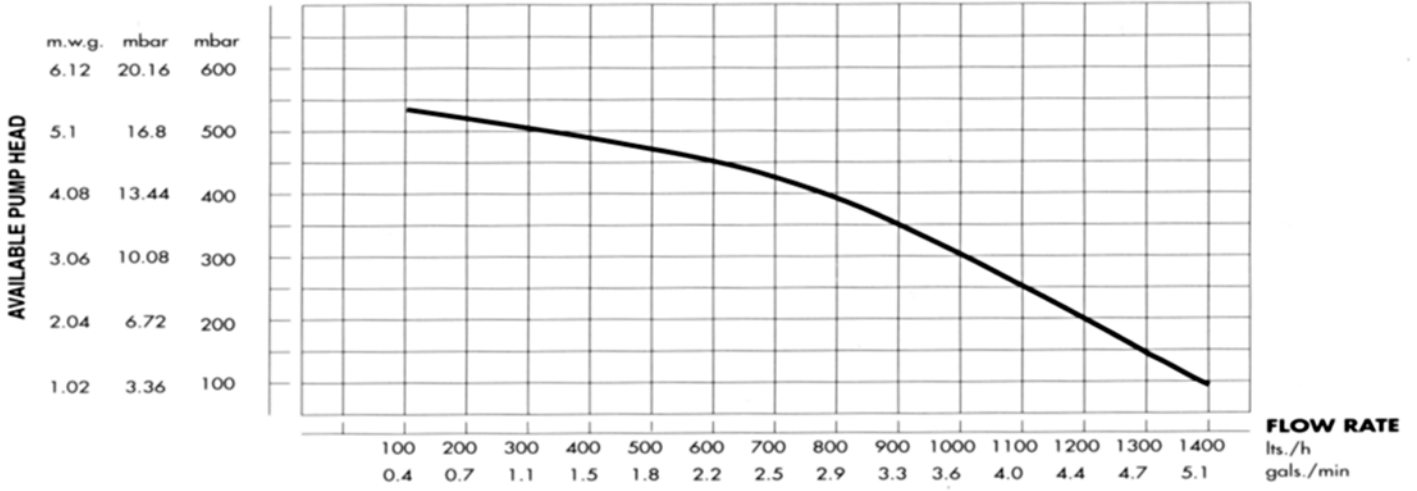

REGULATING HEATING POWER FOR NATURAL GAS (G20)

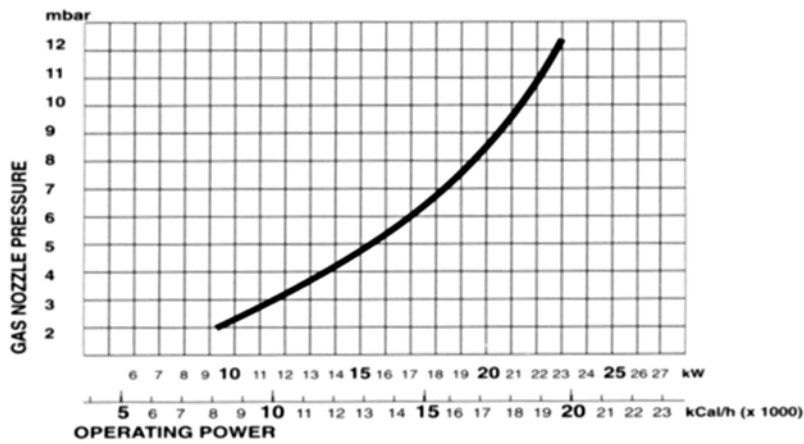

REGULATING HEATING POWER FOR BUTANE GAS (G30)

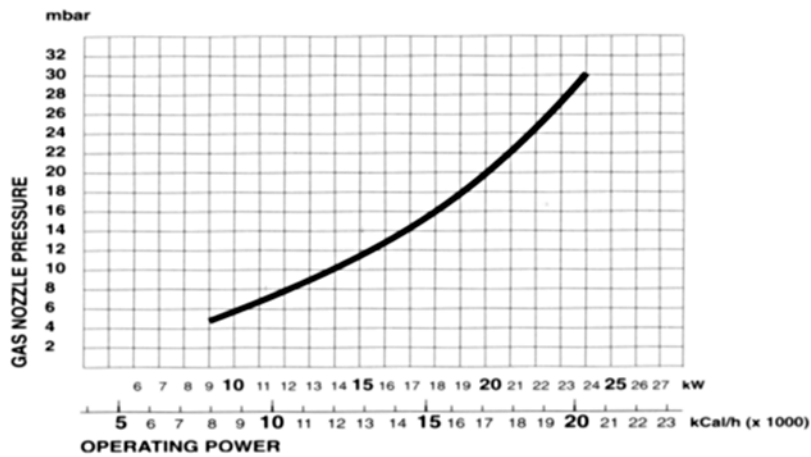

REGULATING HEATING POWER FOR PROPANE GAS (G31)

